

San Mateo County
Department of Public Works

Pescadero Fire Station

1200 Pescadero Creek Road
Pescadero, California 94060

Site Assessment

January 13, 2014



Table of Contents

1. Team	3
2. Project Description – Service Area	4
3. Executive Summary and Recommendations	6
3.1 Option A: New Site.	7
3.2 Option B: Existing Site, with Programmatic Improvements.	8
4. Process and Participants	11
5. Existing Site Analysis	12
5.0 Water risks Assessment	12
5.1 Architectural Assessment	13
5.2 Structural Assessment	20
5.3 Mechanical, Electrical, Plumbing, IT Assessment	21
5.4 Civil Assessment.	22
6. Diagrams	23
SK A1. (New site) Ideal Site Plan	23
SK A2. (New site) Floor Plans	24
SK A3. (New site) Elevations	25
SK B1.0 (Existing site through Phase 2) Site Plan	26
SK B1.1 (Existing site, Phase 1) new Living Quarters floor plan	27
SK B1.2 (Existing site, Phase 1) new Living Quarters elevations.	28
SK B2.1 (Existing site, Phase 2) Apparatus Building drawings	29
7. Cost Analysis.	30
8. Appendices	33
8.0 Water risks documentation	34
8.1 Cost Analysis	35
8.2 Structural report	36
8.3 Mechanical, electrical, and plumbing report	37
8.4 Civil engineering report.	38
8.5 Reference documents.	39

Cover image credits: (top) Herb Lingl/aerialarchives.com, (middle) Lake|Flato Architects, (bottom) Trailstompers.com, <http://www.trailstompers.com/long-ridge-to-portola-redwoods-trail-run.html>

1. Team

San Mateo County Public Works

Cal Fire

Design Team

Architectural

Ratcliff

Structural

Degenkolb Engineers

Civil

CSW/Stuber-Stroeh Engineering Group, Inc.

Mechanical/Electrical/Plumbing

NBA Engineering, Inc.

Cost Analysis

Tbd Consultants

2. Project Description – Service Area

INCIDENT RESPONSE DIRECTION – EXAMINED

A three-year study investigated the direction to which Station 59 responded most often. The result of the study indicated an essentially equal number of responses in both directions. Consequently, the location of a new station in relationship to either the town or the coast was not informed by this study.

By choosing a position to the east of the flood-prone area, on Pescadero Creek Road, at the creek bridge and closer to Town would allow Community Room access to a greater number of area residents, if such a room were included in the New Fire Station program.

Business and commercial access between the town and the coast makes adopting the flooding resolution as critical to the Town’s livelihood as the other routes out of town. Stage Road to the north and Cloverdale Road to the south—both of which are long and circuitous-- impede tourism and commerce as well as firefighting response time.

one area on Pescadero Creek Rd at the Creek bridge and closer to Town would allow a better use of the Community Room if it were included in the program to develop a New Fire Station.

January	27
February	30
March	47
April	49
May	20
June	47
July	48
August	31
September	46
October	48
November	34
December	27
TOTAL	454

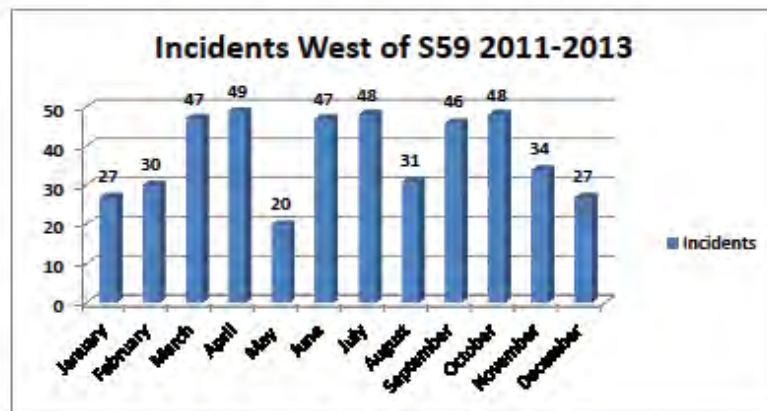

January	38
February	53
March	51
April	52
May	36
June	36
July	29
August	42
September	37
October	18
November	36
December	24
TOTAL	452

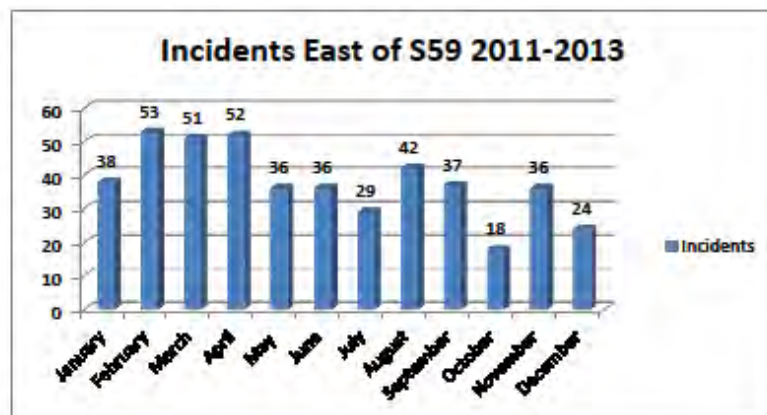

Pescadero and Skylonda First Due Areas

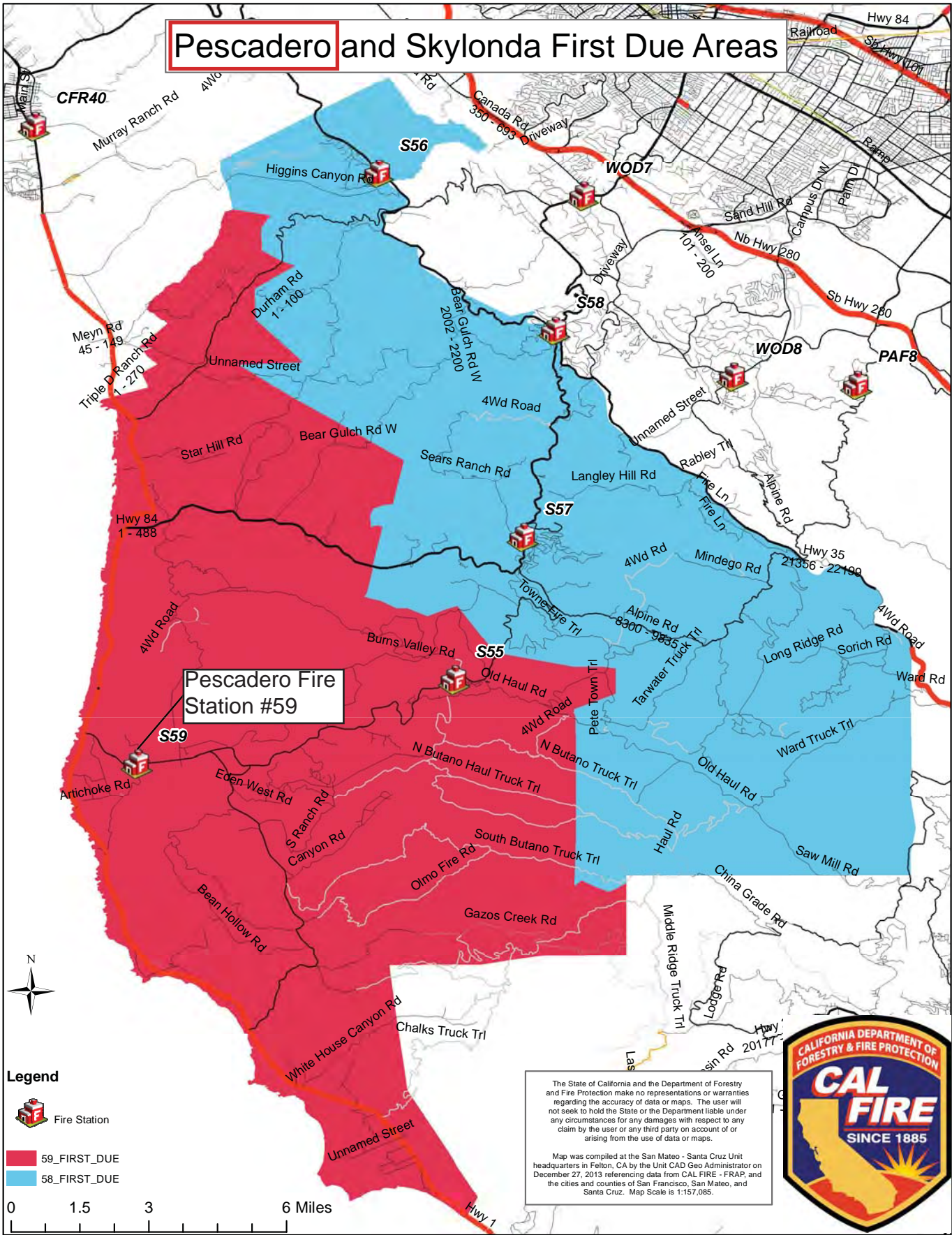

EXHIBIT A. PESCADERO SERVICE AREA

3. Executive Summary and Recommendations

The Team has interviewed the staff at the Fire Station and reviewed the conditions of the existing Pescadero Fire Station to gain an understanding of the current conditions of the facility, its mission and the Service Area.

The service area is indicated in Exhibit A.

There are three full-time firefighters on staff, increasing to 8 or 9 during fire season.

The team has explored several options to mitigate the known water risks at the existing site and bring the facility up to current requirements for its mission.

The options that were considered range from:

Option A: Provides for a new fire station to meet all current criteria by locating an acceptable site near the Town of Pescadero and rebuilding a new, code-compliant, and efficiently operated facility. This site should not be located in the flood plain or in the Tsunami Inundation Zone, as well as outside the limits of 50 year predicted sea level rise (and ideally beyond this limit) in order to protect the investment in the improved facility and properly uphold the public safety mission of the station (see Section 3.1).

Option B: Provides for a new Living Quarter and Command Office area adjacent to a remodeled Apparatus Building, while working within the existing site as it remains open and occupied as a fire station. This appears to provide the most cost effective way to improve the facility's ability to support its mission, but with the understanding that all water risks cannot be mitigated (see Section 3.2).

Option C: Provides for a new Living Quarter and Command Office area adjacent to a remodeled Apparatus Building after temporarily relocating the firefighting services and staff to a location at Pescadero High School Working within the existing site, site provides the most easily constructed improvements project, Again, we emphasize that all water risks cannot be mitigated. This option appears to be more expensive than Option B and was not developed.

Variations of this Option B to save the current site were considered, but it appears that a two phased approach to improvements can be made while allowing staff and equipment to remain on-site. This is the lowest cost approach for this theme. This concept should be verified with a qualified, licensed general contractor to consider all implications of a phased construction sequence that meets all safety requirements for the station, the staff, and the mission should this option be selected to pursue further. It appears that a site access plan for firefighters and the contractor—as well as appropriate construction staging areas—could be developed.

3.1 Option A: New Site.

After completion of Improvements Planning and Cost Analysis for Option B (work with the existing site) and its variations, the team developed the ideas for a new site (location TBD) with the right sized and code compliant station best suited for an efficient operation.

The Team arrived at an optimal space and equipment program after an intensive daylong programming session at the fire station which involved senior firefighter and County Public Works staff. Minor growth in staffing was concluded on, with slow growth in structures predicted for this service area. No apparatus growth was assumed to be necessary at this time, though the placement of the water tender at this site may increase the need for a 4th vehicle bay. This possibility was considered in the conceptual cost estimating and planning by moving the physical training area into a space that had been set aside for a Community Room option that is not present in the current station. This community space was considered a strong asset of consideration if a new station development is to be undertaken. If the water tender is to be kept at this site AND the Community Room option is to be pursued, the programmed area should be increased and reflected in an increased construction budget. This topic needs further discussion.

The station allows for a second floor Living Quarters housed over Command Center, staff offices and the Community Room, both located on the ground level. All spaces are contiguous for an efficient operation. The attached (2) deep apparatus high bays have dual sided access through bi-folding doors and house (3) vehicles and space for physical training and a work shop, convertible to (4) vehicles. The site can park up to (12) staff autos, and (12) public autos. The site can turn around a firefighting vehicle with a 55-foot turning radius, though the maximum radius needed is probably less.

The project consists of a new two-story 8,900 SF fire station with living quarters over offices adjacent to apparatus bays. Sitework includes vehicular and pedestrian paving, landscaping, site lighting and drainage, new emergency generator and fuel storage tanks. Utilities include incoming City water, storm drain and electrical service. Sewer is provided by an onsite septic system, gas is provided by propane tanks.

The projected New Station criteria:

Minimum Site Area: 39,775 SF

Minimum Building Area: 8,100 GSF

Massing: Two-story Living Quarters over Command Center and Offices

Emergency Operations design criteria met.

Programmed area includes room for indoors housing of up to:

- 12 firefighters
- 3 firefighting vehicles
- Community Room (doubles as area needed to meet EOC criteria).
- Design Character (see Zoning requirements in Section 6.1 Architectural)
- Patterned after a Rural Agricultural Structure.
- Clean simple lines
- Steep pitched roof
- Symmetrical opening where possible
- Metal Siding and Roofing or other durable material.

Projected Construction Cost: \$5,139,058 (without land cost)

See Section 6. Diagrams:

Site Plan: SK A1

Floor Plans: SK A2

3.2 Option B: Existing Site, with Programmatic Improvements.

The Team arrived at an appropriate space and equipment program after an intensive daylong programming session at the fire station which involved senior firefighter and County Public Works staff. Minor growth in staffing was concluded on, with only slow growth in structures predicted in this service area. Apparatus growth was assumed unnecessary at this time, though the placement of the water tender at this site may increase the need for a 4th vehicle bay. See additional notes in Option A.

The station allows for a second floor Living Quarters to be housed over the command center, staff offices and the community room on the ground level. All spaces are contiguous for an efficient operation.

The original apparatus building steel frame and concrete pad remains. All other aspects of the facility are demolished as they are not code compliant or are at the end of useful life, For details, see Section 5. Site Assessment Reports and Section 8. Appendices.

The existing detached apparatus high bays [would] have single sided access through new bi-folding doors and house (3) vehicles, with space for physical training and a work shop. It is convertible to (4) vehicles. The site can park up to (12) staff autos, and (9) public autos. The site cannot turn around a firefighting vehicle with a 55' turning radius though the maximum radius needed is probably less.

Project consists of replacing existing living quarters building with a new two-story 5,508 SF Living Quarters building, complete interior/exterior renovation to the existing 2,400 SF apparatus building, including a new 1,100 SF addition. Sitework includes vehicular and pedestrian paving, landscaping, site lighting, drainage, and replacement of the existing emergency generator and fuel storage tanks. Utilities include septic system replacement and connecting existing utilities to new buildings.

The projected Station Programmatic Improvements criteria:

Current Site Area: 56,062 SF

Minimum Building Area: 8,900 GSF

Massing: 2 story Living Quarters over Command Center and Offices,
Adjacent to existing 1 story Apparatus Building with rear addition.

Emergency Operations design criteria met.

Programmed area includes room for indoors housing of up to:

- 12 firefighters
- 3 firefighting vehicles
- Community Room (doubles as area needed to meet EOC criteria).

Design Character (see Zoning requirements in Section 6.1 Architectural)

- Patterned after a Rural Agricultural Structure.
- Clean simple lines

- Steep pitched roof
- Symmetrical openings where possible
- Metal Siding and Roofing or other durable material.

Projected Construction Cost: \$5,728,568

Option B - Site Phasing:

Firefighting Operations remain active on site during construction.

Phase 1: build New 2 Story Addition:

- Demo or relocate temporarily storage containers and sheds on west side
- Demo AC driveway and, possibly, (2) Monterey Pine trees
- Relocate utilities as needed
- Build (2) story New Addition, with Living Quarters over the Offices
- Build New Patio 12'x20' with cover roof to west and outdoor BBQ.

Phase 2A: Move staff into New Addition:

- Relocate new command center from Apparatus Building into New Addition offices on first level
- Move into Living Quarters and Offices
- Demo existing Living Quarters.

Phase 2B: Renovate Apparatus Building.

- Relocate vehicles to paved yard, possibly under tent structures
- Relocate turnout gear and supplies to storage mods or into first floor of New Addition
- Demo all interior construction in eastern most bay of Apparatus Building
- Demo rear wood frame addition of Apparatus Building
- Demo Apparatus Building exterior siding and roof
- Build Apparatus Building New Addition: 10' wide, full length of the rear of existing steel prefab bldg. Metal stud on-slab, on-grade construction, same skin and roof as below. 10' min height, 3/12 pitch
- Verify site drainage to hillside cut on south side. Provide additional cut and hillside stabilization, with a keystone wall if required.
- Apply new exterior walls to Apparatus Building (sheet metal siding over sheathing, membrane, new metal studs, interior gyp board)
- Rebuild Apparatus Building roof (sheet metal siding over sheathing, membrane, new plywood, verify existing framing)
- Provide (4) new bi-fold vehicle garage doors on auto operators
- Provide new floor seal for all Apparatus Building. areas, "gym flooring" at west bay, and new, 1-hour rated gyp board on metal stud partition walls to separate new physical training area from new shop and apparatus bays. Include rated doors.
- Provide all new MEP for the Apparatus Building. New Heat/Vent/Vehicle exhaust snorkels/no AC. All new lighting, power, and AV.

3.2 Option B: Existing Site, with Programmatic Improvements – VARIATIONS

The current site could possibly be isolated from Hwy 1 and the coastal areas it serves if a Tsunami

or flooding occurs during an incident requiring emergency response. A separate study for the consideration of a mobile command center of this site should be undertaken.

For the variety of situations that could be faced in this remote fire station, this type of vehicle may be more useful than additional real estate, which would need to be maintained. New real estate would become a fixed asset in a large service area with multiple potential risk types. A custom command vehicle that can house up to 3-4 firefighters, rescue equipment, and wireless communications should be programmed and priced for further consideration before a remote mini-station project is under taken.

4. Process and Participants

San Mateo County

Guido Misculin, Head of Facilities Planning

Theresa Yee, Senior Capital Projects Manager

Cal Fire

Scott Ernest, Cal Fire

Robert Pierson, Cal Fire

Andy Cope, Cal Fire

Scott Jalbert, Cal Fire, Santa Cruz Unit Chief

Ratcliff Architects

Bill Blessing, Principal Architect

Nina Pakanant, Designer

Dan Johnson, Designer

TBD Consultants

Gary Holland, Senior Estimator

CSW/Stuber-Stroeh Engineering Group, Inc.

Kerry Ettinger, PE Civil

NBA Engineering, Inc.

Natalie Alavi, PE

5. Existing Site Analysis

5.0 Water risks Assessment

The Pescadero Fire Station Assessment Study is driven by the known water risks associated with its location on the Pescaedro and Butano Creek drainage plains and its proximity to the Pacific Ocean Coast. These risks include: seasonal flooding caused by proximity to the Creeks, which could be worsened by rising sea levels due to climate change (see Appendix 8.0), and/or a tsunami event (see Appendix 8.0) due to the potential of earthquake events.

The latter two pose risk categories unto themselves and both have ongoing research with still-indeterminate predictions, but remain as known risks to this site.

The working area of this site (developed for buildings and emergency vehicles) is currently between elevation +13 and +16 ft above mean Sea level. A portion of the site on the SW corner rises up a hill and is not useable for general re-development of the fire station.

After reviewing current studies on the three types of water risks (see Appendices), it appears that the seasonal flooding of the site is most the controllable of the three and yet is mired in determining the final mitigation solution and permitting process (see Appendices). A solution could entail an extensive first Phase of study of the civil engineering within the drainage plain systems and with possible adjacent road work. This study needs to be completed before an additional study as to what affect this first Phase will have on the correct direction for the Fire Station site on Pescadero Creek Road.

In lieu of these studies, the current Assessment Report has taken the approach that the site cannot be easily raised, without a companion work scope that also raises the adjacent roads or other solution in the creek drainage plain. This variable has been set aside and our Team has completed a standalone review of the existing facilities for appropriateness to their firefighting/emergency response mission in terms of operations and their physical condition. The results have then been used to predict what would be needed to bring them into compliance for their intended mission, pending a solution to the seasonal flooding risk which is believed to be achievable. What is missing then is: at what elevation will the new work at the site be set? While this question remains unanswered, within the context of the entire Assessment Report, we still can recommend not continuing to develop this site due to all the water risks associated with this site.

If the seasonal flooding risk is mitigated at this site, it still does not diminish the other two important water risks: rising seal levels and tsunami events, which make vulnerable this site serving its mission.

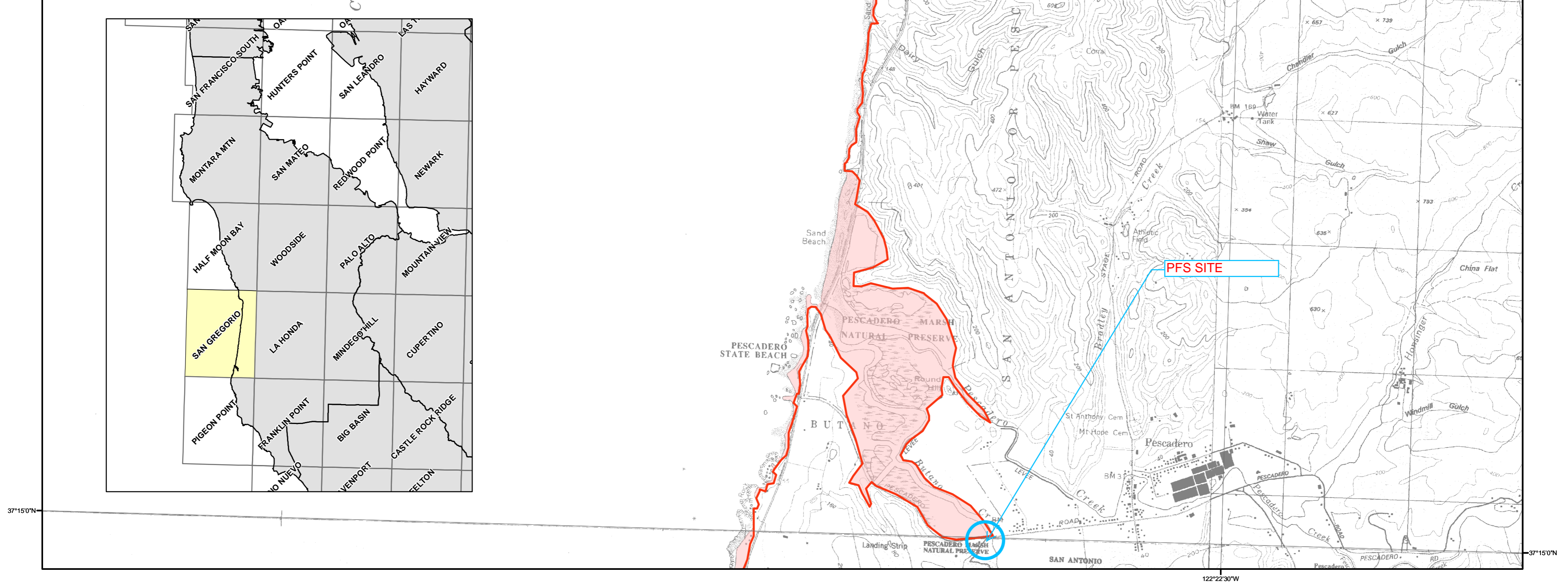

METHOD OF PREPARATION

Initial tsunami modeling was performed by the University of Southern California (USC) Tsunami Research Center funded through the California Emergency Management Agency (CalEMA) by the National Tsunami Hazard Mitigation Program. The tsunami modeling process utilized the MOST (Method of Splitting Tsunamis) computational program (Version 0), which allows for wave evolution over a variable bathymetry and topography used for the inundation mapping (Titov and Gonzalez, 1997; Titov and Synolakis, 1998).

The bathymetric/topographic data that were used in the tsunami models consist of a series of nested grids. Near-shore grids with a 3 arc-second (75- to 90-meters) resolution or higher, were adjusted to "Mean High Water" sea-level conditions, representing a conservative sea level for the intended use of the tsunami modeling and mapping.

A suite of tsunami source events was selected for modeling, representing realistic local and distant earthquakes and hypothetical extreme undersea, near-shore landslides (Table 1). Local tsunami sources that were considered include offshore reverse-thrust faults, restraining bends on strike-slip fault zones and large submarine landslides capable of significant seafloor displacement and tsunami generation. Distant tsunami sources that were considered include great subduction zone events that are known to have occurred historically (1960 Chile and 1964 Alaska earthquakes) and others which can occur around the Pacific Ocean "Ring of Fire."

In order to enhance the result from the 75- to 90-meter inundation grid data, a method was developed utilizing higher-resolution digital topographic data (3- to 10-meters resolution) that better defines the location of the maximum inundation line (U.S. Geological Survey, 1993; Intermap, 2003; NOAA, 2004). The location of the enhanced inundation line was determined by using digital imagery and terrain data on a GIS platform with consideration given to historic inundation information (Lander, et al., 1993). This information was verified, where possible, by field work coordinated with local county personnel.

The accuracy of the inundation line shown on these maps is subject to limitations in the accuracy and completeness of available terrain and tsunami source information, and the current understanding of tsunami generation and propagation phenomena as expressed in the models. Thus, although an attempt has been made to identify a credible upper bound to inundation at any location along the coastline, it remains possible that actual inundation could be greater in a major tsunami event.

This map does not represent inundation from a single scenario event. It was created by combining inundation results for an ensemble of source events affecting a given region (Table 1). For this reason, all of the inundation region in a particular area will not likely be inundated during a single tsunami event.

References:

Intermap Technologies, Inc., 2003, Intermap product handbook and quick start guide: Intermap NEXMap document on 5-meter resolution data, 112 p.

Lander, J.F., Lockridge, P.A., and Kozuch, M.J., 1993, Tsunamis Affecting the West Coast of the United States 1806-1992: National Geophysical Data Center Key to Geophysical Record Documentation No. 29, NOAA, NESDIS, NGDC, 242 p.

National Atmospheric and Oceanic Administration (NOAA), 2004, Interferometric Synthetic Aperture Radar (IFSAR) Digital Elevation Models from GeoSAR platform (EarthData): 3-meter resolution data.

Titov, V.V., and Gonzalez, F.I., 1997, Implementation and Testing of the Method of Tsunami Splitting (MOST): NOAA Technical Memorandum ERL PMEL – 112, 11 p.

Titov, V.V., and Synolakis, C.E., 1998, Numerical modeling of tidal wave runup: Journal of Waterways, Port, Coastal and Ocean Engineering, ASCE, 124 (4), pp 157-171.

U.S. Geological Survey, 1993, Digital Elevation Models: National Mapping Program, Technical Instructions, Data Users Guide 5, 48 p.

TSUNAMI INUNDATION MAP FOR EMERGENCY PLANNING

State of California ~ County of San Mateo
SAN GREGORIO QUADRANGLE

June 15, 2009

SCALE 1:24,000

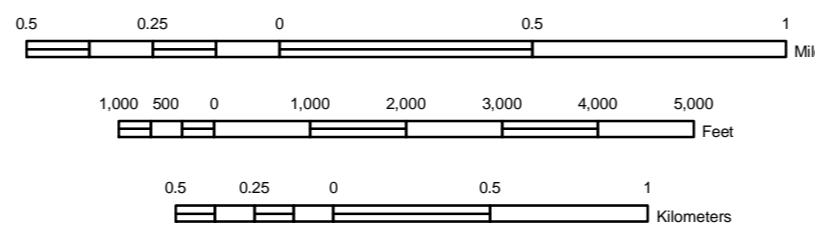



Table 1: Tsunami sources modeled for the San Mateo County coastline.

Sources (M = moment magnitude used in modeled event)		Areas of Inundation Map Coverage and Sources Used	
		San Francisco Bay	Pescadero
Local Sources	Point Reyes Thrust Fault	X	
	Rodgers Creek-Hayward Faults	X	
	San Gregorio Fault	X	
Distant Sources	Cascadia Subduction Zone-full rupture (M9.0)	X	
	Central Aleutians Subduction Zone #1 (M8.9)	X	X
	Central Aleutians Subduction Zone #2 (M8.9)	X	
	Central Aleutians Subduction Zone #3 (M9.2)	X	X
	Chile North Subduction Zone (M9.4)	X	
	1960 Chile Earthquake (M9.3)	X	
	1964 Alaska Earthquake (M9.2)	X	X
	Japan Subduction Zone #2 (M8.8)	X	
	Kuril Islands Subduction Zone #2 (M8.8)	X	
	Kuril Islands Subduction Zone #3 (M8.8)	X	
Kuril Islands Subduction Zone #4 (M8.8)	X		
Marianas Subduction Zone (M8.6)	X	X	

MAP EXPLANATION

-  Tsunami Inundation Line
-  Tsunami Inundation Area

PURPOSE OF THIS MAP

This tsunami inundation map was prepared to assist cities and counties in identifying their tsunami hazard. It is intended for local jurisdictional, coastal evacuation planning uses only. This map, and the information presented herein, is not a legal document and does not meet disclosure requirements for real estate transactions nor for any other regulatory purpose.

The inundation map has been compiled with best currently available scientific information. The inundation line represents the maximum considered tsunami runup from a number of extreme, yet realistic, tsunami sources. Tsunamis are rare events; due to a lack of known occurrences in the historical record, this map includes no information about the probability of any tsunami affecting any area within a specific period of time.

Please refer to the following websites for additional information on the construction and/or intended use of the tsunami inundation map:

State of California Emergency Management Agency, Earthquake and Tsunami Program:
<http://www.oes.ca.gov/WebPage/oeswebsite.nsf/Content/B1EC51BA215931768825741F005E8D80?OpenDocument>

University of Southern California – Tsunami Research Center:
<http://www.usc.edu/dept/tsunamis/2005/index.php>

State of California Geological Survey Tsunami Information:
http://www.conservation.ca.gov/cgs/geologic_hazards/Tsunami/index.htm

National Oceanic and Atmospheric Agency Center for Tsunami Research (MOST model):
<http://nctr.pmel.noaa.gov/time/background/models.html>

MAP BASE

Topographic base maps prepared by U.S. Geological Survey as part of the 7.5-minute Quadrangle Map Series (originally 1:24,000 scale). Tsunami inundation line boundaries may reflect updated digital orthophotographic and topographic data that can differ significantly from contours shown on the base map.

DISCLAIMER

The California Emergency Management Agency (CalEMA), the University of Southern California (USC), and the California Geological Survey (CGS) make no representation or warranties regarding the accuracy of this inundation map nor the data from which the map was derived. Neither the State of California nor USC shall be liable under any circumstances for any direct, indirect, special, incidental or consequential damages with respect to any claim by any user or any third party on account of or arising from the use of this map.



5.1 Architectural Assessment

SITE:

CALFIRE / Pescadero Fire Station, San Mateo County Fire Department
1200 Pescadero Creek Road, Pescadero, Ca 94060
(corner of Pescadero Creek Road and Bean Hollow Rd.)

SITE FACTS:

APN: 086160050

SITE AREA: 56,062 sqft.

ASSESSOR LEGAL DESCRIPTION:

1.287 AC MOL ON SLY LN OF PESCADERO RD BEING PTN OF LOT 13 & PTN OF RESERVED
PARCEL PENINSULA FARMS CO SUB NO 1 RSM 11/18

GENERAL PLAN (1986)

<http://planning.smcgov.org/documents/local-coastal-program-lcp>

Local Coastal Program Area (1980), Rural Service Centers

DESIGNATION: Institutional Land Use

Bounded by General Open Space (OS), Public Recreation (marsh), Private lands

Local Coastal Program (LCP)

All development in the Coastal Zone requires either a Coastal Development Permit or an exemption from Coastal Development Permit requirements. For a permit to be issued, the development must comply with the policies of the Local Coastal Program (LCP) and those ordinances adopted to implement the LCP. The project must also comply with other provisions of the County Ordinance Code, such as zoning, building and health regulations.

LOCAL COASTAL PROGRAM POLICIES (verify):

http://planning.smcgov.org/sites/planning.smcgov.org/files/documents/files/SMC_Midcoast_LCP_2013.pdf

LOCATING AND PLANNING NEW DEVELOPMENT COMPONENT DEVELOPMENT REVIEW

1.1 Coastal Development Permits

After certification of the Local Coastal Program (LCP), require a Coastal Development Permit for all development in the Coastal Zone subject to certain exemptions.

1.2 Definition of Development

*As stated in Section 30106 of the Coastal Act, define development to mean:
On land, in or under water, the placement or erection of any solid material or structure; discharge or disposal of any dredged material or any gaseous, liquid, solid, or thermal waste; grading, removing, dredging, mining, or extraction of any materials; change in the density or intensity of use of land, including, but not*

limited to, subdivision pursuant to the Subdivision Map Act (commencing with Section 66410 of the Government Code), and any other division of land, including lot splits, except where the land division is brought about in connection with the purchase of such land by a public agency for public recreational use; change in the intensity of use of water, or of access thereto; construction, reconstruction, demolition, or alteration of the size of any structure, including any facility of any private, public, or municipal utility; and the removal or harvesting of major vegetation other than for agricultural purposes, kelp harvesting, and timber operations which are in accordance with a timber harvesting plan submitted pursuant to the provisions of the Z'berg-Nejedly Forest Practice Act of 1973 (commencing with Section 4511).

As used in this section, "structure" includes, but is not limited to, any buildings, road, pipe, flume, conduit, siphon, aqueduct, telephone line, and electrical power transmission and distribution line.

ITEMS to be verified include:

Appendix 1.A
Minimum Stormwater Pollution Prevention Requirements
Pages 1.27 thru 1.30

Items Apply to PFS: 3.c; 3.e, 3.f, 3.j
Verify that current septic field location would not be allowed by this standard: Items 3.i and 3.j.

*3. Developments of Special Concern
j. On-site sewage treatment systems (septic systems) shall be sited away from areas that have poorly or excessively drained soils, shallow water tables or high seasonal water tables that are within floodplains or where effluent cannot be adequately treated before it reaches streams or the ocean. New development with conventional or alternative on-site sewage treatment systems shall include protective setbacks from surface waters, wetlands and floodplains, as well as appropriate separation distances between on-site sewage treatment system components, building components, property lines, and groundwater as required by the Regional Board. Under no conditions shall the bottom of the effluent dispersal system be within five (5) feet of groundwater.*

SENSITIVE HABITATS

WETLANDS:

Page 7.5
Site is adjacent to protected Wetland.

*7.15 Designation of Wetlands
a. Designate the following as wetlands requiring protection: Pescadero Marsh,...*

Page 7.6
Verify if current site and proposed development in Option B are outside of required

Buffer Zone.

7.18 Establishment of Buffer Zones

Buffer zones shall extend a minimum of 100 feet landward from the outermost line of wetland vegetation. This setback may be reduced to no less than 50 feet only where: (1) no alternative development site or design is possible; and (2) adequacy of the alternative setback to protect wetland resources is conclusively demonstrated by a professional biologist to the satisfaction of the County and the State Department of Fish and Game. A larger setback shall be required as necessary to maintain the functional capacity of the wetland ecosystem.)

Page 7.7

7.21 Management of Pescadero Marsh

Other items may apply.

VISUAL RESOURCES:

Verify if these Design Guidelines apply to institutional buildings constructed after April 29, 1998 at this site for proposed development in Option B:

Provisional Appendix - In-Progress Development Proposals Not Affected by the LCP Amendments Certified by the Coastal Commission on April 29, 1998PA.1-PA.13

*8.13 Special Design Guidelines for Coastal Communities Pages PA.9 thru PA.13
d. Pescadero*

Encourage new buildings to incorporate architectural design features found in the historic buildings of the community (see inventory listing), i.e., clean and simple lines, precise detailing, steep roof slopes, symmetrical relationship of windows and doors, wood construction, white paint, etc. Require remodeling of existing buildings to retain and respect their traditional architectural features, if any.

Note:

Other items may apply if the Option A - New Site approach is determined and defined.

ZONING INFORMATION, Unincorporated Areas

http://planning.smcgov.org/sites/planning.smcgov.org/files/2012_ZoneRegs%5BFINAL%5D_0.pdf

ZONING MAP

https://planning.smcgov.org/sites/planning.smcgov.org/files/documents/files/smc_zoning.pdf

DESIGNATION: PAD/CD (combined districts)

Planned Agricultural Districts/Coastal Development Districts

Items Apply:

CHAPTER 20A.2. DEVELOPMENT REVIEW CRITERIA

(applicable sections, partial list)

- SECTION 6325.2. PRIMARY FISH AND WILDLIFE HABITAT AREAS CRITERIA.
- SECTION 6325.7. PRIMARY NATURAL VEGETATIVE AREAS CRITERIA.
- SECTION 6326. SUPPLEMENTARY REVIEW CRITERIA FOR SPECIAL HAZARD
- SECTION 6326.1. FLOOD PLAIN AREA CRITERIA.

Verify that Option B development is permitted per:

- SECTION 6326.2. TSUNAMI INUNDATION AREA CRITERIA. The following criteria shall apply within all areas defined as Tsunami Inundation Hazard Areas. (a) The following uses, structures, and development shall not be permitted: publicly owned buildings intended for human occupancy other than park and recreational facilities; schools, hospitals, nursing homes, or other buildings or development used primarily by children or physically or mentally infirm persons.
- SECTION 6326.3. SEISMIC FAULT/FRACTURE AREA CRITERIA.

CHAPTER 20B. "CD" DISTRICT (COASTAL DEVELOPMENT DISTRICT)

SECTION 6328.4. REQUIREMENT FOR COASTAL DEVELOPMENT PERMIT.

Except as provided by Section 6328.5, any person, partnership, corporation or state or local government agency wishing to undertake any project, as defined in Section 6328.3(r), in the "CD" District, shall obtain a Coastal Development Permit in accordance with the provisions of this Chapter, in addition to any other permit required by law. Development undertaken pursuant to a Coastal Development Permit shall conform to the plans, specifications, terms and conditions approved or imposed in granting the permit.

SECTION 6328.5. EXEMPTIONS.

The projects listed below shall be exempt from the requirement for a Coastal Development Permit. Requirements for any other permit are unaffected by this section.

(b) The maintenance, alteration, or addition to existing structures other than single family dwellings and public works facilities; however, the following classes of development shall require a permit because they involve a risk of adverse environmental impact:

(3) The expansion or construction of water wells or septic systems.

(4) On property located between the sea and the first public road paralleling the sea or within 300 feet of the inland intent of any beach or of the mean high tide of the sea where there is no beach, whichever is the greater distance, or in scenic road corridors, an improvement that would result in an increase of 10% or more of external floor area of the existing structure, and/or the construction of an additional story (including lofts) in

an existing structure.

CHAPTER 21A. "PAD" DISTRICT (PLANNED AGRICULTURAL DISTRICT)

This chapter has sections that may apply to Option A - New Site development location.

SECTION 6353. USES PERMITTED SUBJECT TO THE ISSUANCE OF A PLANNED AGRICULTURAL PERMIT.

The following uses are permitted in the PAD subject to the issuance of a Planned Agricultural Permit, which shall be issued in accordance with the criteria set forth in Section 6355 of this ordinance. Applications for Planned Agricultural Permits shall be made to the County Planning Commission and shall be considered in accordance with the procedures prescribed by the San Mateo County Zoning Ordinance for the issuance of use permits and shall be subject to the same fees prescribed therefore.

*B. On Lands Suitable for Agriculture and Other Lands
6. Fire stations.*

Site Visit

The Architectural Team worked on October 28, 2012 and the entire A+E Consultant Team worked on November 20, 2013 to complete assessments on the PFS site at 1200 Pescadero Creek Road.

This included a brief tour of potential replacement or remote sites in and around the Town of Pescadero.

Existing site features

- The site is partially surrounded by a 6 foot high wood fence for visual screening.
- No security fence or gates are present.
- The site has a steep hill in the southwest corner.
- Site pavement generally consists of asphalt, depth and section is unknown.
- Concrete pavement is found at the vehicle wash area, fuel station and certain pedestrian building access points; sections are unknown.
- No recent site survey was performed or is currently available through the SM County GIS system.

Relative topo information was located here:

- smc-400 Scale Contour-grid-22D.pdf (SM Cty GIS system).

Additional relative topo information was taken from Google Earth Pro:

- Pescadero Cr_els at 1200 & 5631.pdf

The site has Monterey Pine trees – see Google Earth map.

Existing structures

- Living Quarters (barracks), dated: 1/7/1957

- 2175 GSF
- 1789 ASF
- Wood frame, Type 5 construction
- Composition Shingle roof
- Interiors are well-maintained but worn in the restrooms, kitchen and dining areas.
- This building has been flooded more than 3 times in recent memory and has been repaired each time. Standing water and contaminated soil were visible in the crawl space the day of our inspection.
- An addition was built by the station staff in the early 1980's to enclose the original porch to create additional space in the Dayroom ("recreation room" per original drawings).
- ADA non-compliant.
- Operationally, the ideal set up is to have the Living Quarters adjacent to the Command Office and Apparatus Building to improve response time and not across the service yard as is currently.
- This building has no provision for Community space or interface - and is inadequate for training or as an Emergency Operations Center (EOC) by current standards.
- Finish Floor elevation is approximately 15'.
- Apparatus Building (barracks), dated: 1/7/1957
 - 3128 GSF
 - 1789 ASF
 - Steel frame superstructure – non protected, wood frame infill, Type 5 construction, and not fire-sprinklered.
 - Sheet metal roof and stained wood siding appear well maintained.
 - Interiors are worn in all areas but Command Offices are well maintained.
 - The interior loft space above the Command Office is used for supplies storage and is only accessible by site built wooden wall ladder. This arrangement is unsafe and not per Code.
 - A rear wood frame addition was built in the early 1980's to create space for a physical training area. It is damp and cramped and not isolated from the apparatus bays and has shared air quality. It is not ideally sized and is without daylight, proper height and MEP systems appropriate to its function.
 - ADA non-compliant
 - Operationally, the ideal set up is to have the Apparatus Building adjacent to the Command Office/ Living Quarters to improve response time and not across the service yard as is currently.
 - This building has no provision for Community space or interface - and is inadequate for training or as an Emergency Operations Center (EOC) by current standards.
 - Finish Floor elevation is approximately 16'.
- Equipment Sheds – to create additional covered and secure storage capacity.
 - 335 GSF
 - 325 ASF
 - Steel shipping container (190 GSF) (age ?)
 - Wood frame, prefab – non protected, Type 5 construction (80 GSF), w/a rear, wood-frame addition – non protected, Type 5 construction (64 G)

- [appears to have been built in the 1990's (verify date)]
 - Composition Shingle roof (age : 20 yrs + ?)
- ADA non-compliant
- These structures are inadequate as part of an Emergency Operations Center (EOC) by current standards.
- The wood siding and metal enclosure siding is worn and damaged by earth contact in places. These have no permanent foundations, lighting or HVAC systems.
- Finish Floor elevations is approximately 16'.

- Hazardous Materials Shed
 - 113 GSF
 - 85 ASF
 - CMU walls, wood frame roof – non protected, Type 5 construction
 - Composition Shingle roof (age : 20 yrs + ?)
 - ADA non-compliant
 - Condition appears acceptable but should be re-sealed at exterior wall surfaces.
 - Finish Floor elevations is approximately 16'.

- Emergency Generator Shed
 - 102 GSF
 - 89 ASF
 - Wood frame – non protected, Type 5 construction
 - Appears to have been built in the early 1980's (verify date)
 - Composition Shingle roof (age : 20 yrs + ?)
 - Composition Shingle roof (age : 20 yrs + ?)
 - ADA non-compliant
 - Finish Floor elevations is approximately 14'.

Note:

For all structures, see Engineer Reports below for status of building systems.

5.2 Structural Assessment

Refer to Appendix 8.2 for complete consultant's report.

A building structural assessment per *ASCE 41: Seismic Rehabilitation of Existing Buildings* was conducted. Aspects of building performance that are considered include structural, nonstructural, and foundation/geologic hazard issues. Lifelines such as water, electrical, gas and waste, etc., beyond the perimeter of the building are not considered.

5.2.1 Barracks Building

An ASCE 41-13 Life Safety basic checklist evaluation identifies the structure as being predominately compliant. Unknown factors of liquefaction and surface fault rupture which need to be review by a Geotechnical engineer. The Barracks building is part of an emergency response facility. Therefore an Immediate Occupancy performance level is required. An ASCE 41-13 Immediate Occupancy checklist evaluation for W1 structures identified a number of noncompliant items. These identified issues are all minor in nature and could be retrofitted without significant cost.

The major compliance issue with achieving an Immediate Occupancy building performance level is the structure being located in an area subject to flooding. Flooding will damage the structure and will render the building inoperable during the period of the flood, which would make an Immediate Occupancy performance level difficult to achieve even after a structural retrofit.

5.2.2 Apparatus Building

An ASCE 41-13 Life Safety basic checklist evaluation identifies the structure as being predominately noncompliant or unknown. Some of these identified issues are a mezzanine structure not being independently braced and no confirmation that the original steel system has capacity for the various additions. The Apparatus building is part of an emergency response facility. Therefore an Immediate Occupancy performance level is required. An ASCE 41-13 Immediate Occupancy checklist evaluation for S3 structures identified a number of noncompliant items. It would be anticipated that the identified issues would be major in nature and could be a challenge to retrofit without significant cost.

Two additional compliance issues required to achieve an Immediate Occupancy building performance level are the structure being located in an area subject to flooding and being located adjacent to a slope.

5.3 Mechanical, Electrical, Plumbing, IT Assessment

Refer to Appendix 8.3 for complete consultant's report.

5.3.1 Electrical Systems Existing Conditions

Most of the electrical equipment, including the standby generator (see EE2), and automatic transfer switch (see EE3), has been in use for more than thirty years. The coastal climate, severe weather conditions, and some flooding have caused rusting of the enclosed outdoor service entrance equipment (see EE1). Many broken, inadequate, or unsafe electrical conditions are noted in the report (Appendix 8.3).

5.3.2 Plumbing and Mechanical Systems Existing Conditions

The septic tank floods periodically, requiring station personnel to rent and use portable toilet facilities when the septic system is being repaired and cleaned. Fuel tanks show rust and evidence of leakage. Mechanical ventilation to occupied spaces is missing or inadequate. Some rooms have not heat. The consultant recommends demolishing all existing mechanical, plumbing, fuel, and electrical systems.

5.4 Civil Assessment

The site and buildings are outdated and in need of improvement, either at the existing site, or at a new site, in order to meet current standards and to adequately serve its community. The Pescadero Fire Sta. is located in the flood plain of the Butano Creek (see “Pescadero Floodway Map” attached, Appendix 8.4) The site is has experienced an increase in the occurrence of flooding since the mid 1980’s due to the accumulation of silt and debris in Butano Creek and Pescadero Marsh as a result of halted dredging operations.

Civil utilities on-site consist of domestic water served by the local water service municipality. The septic system is reported to back-up during flood events, which is to be expected. A new septic system will likely be required. Because the location of the existing system becomes inundated with water during flood events (see Appendix 8.4, Photo 1), it is unlikely that this location will meet code. As such, alternative locations on site should be considered.

6. Diagrams

SK A1. (New site) Ideal Site Plan

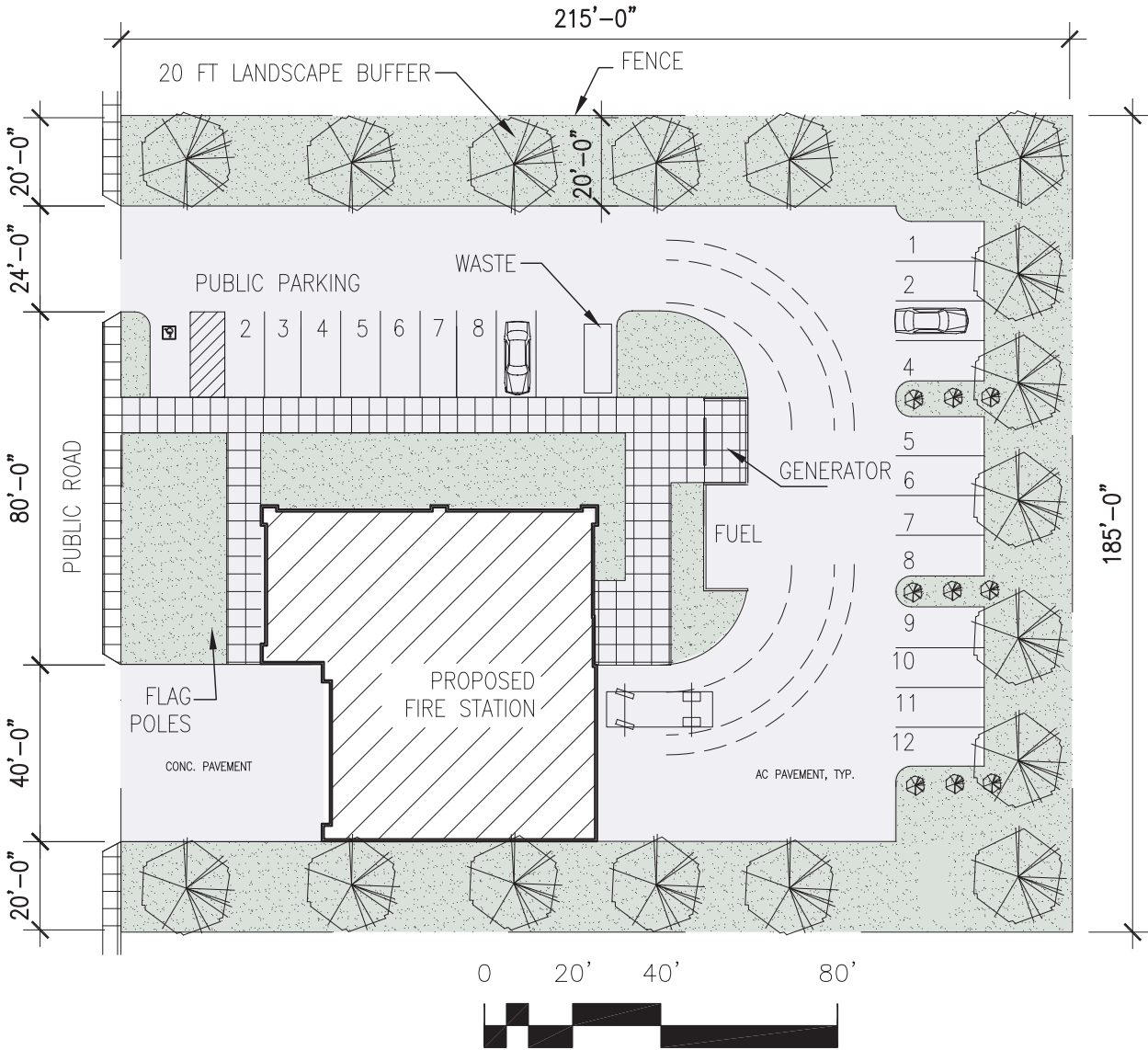

SK A2. (New site) Floor Plans

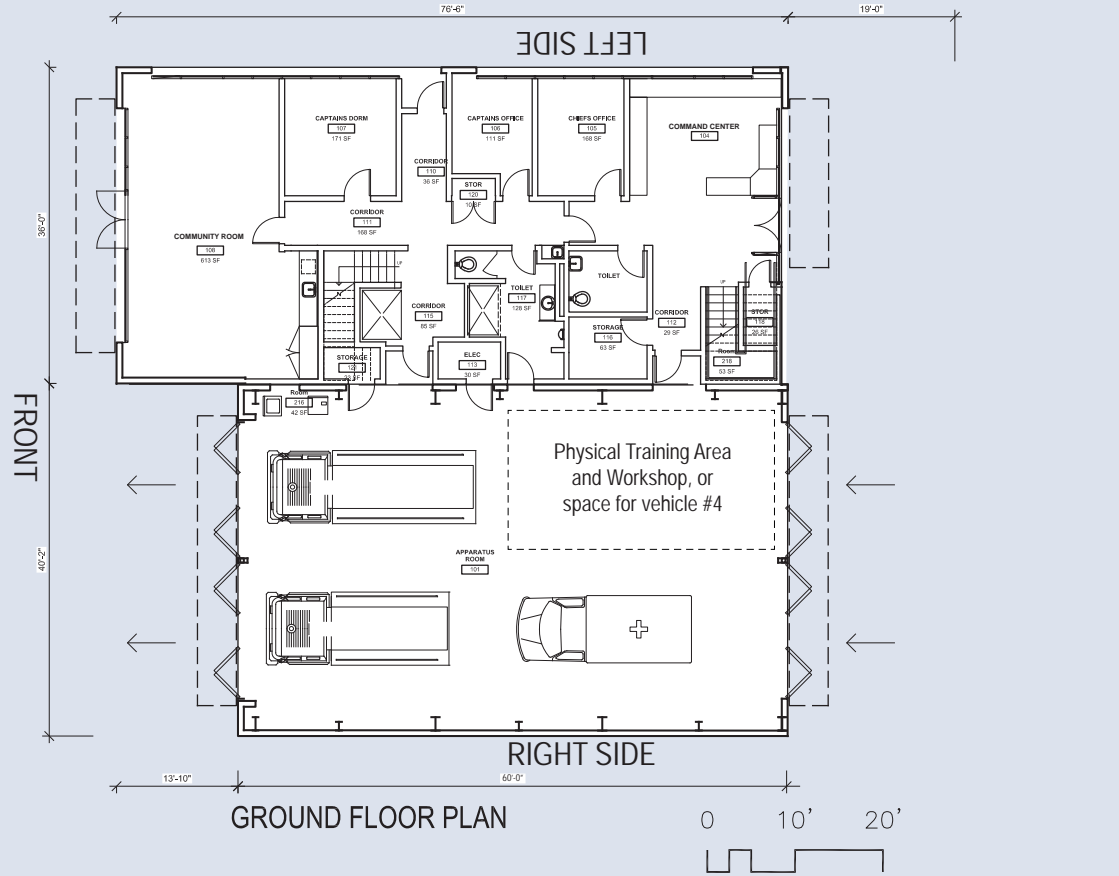
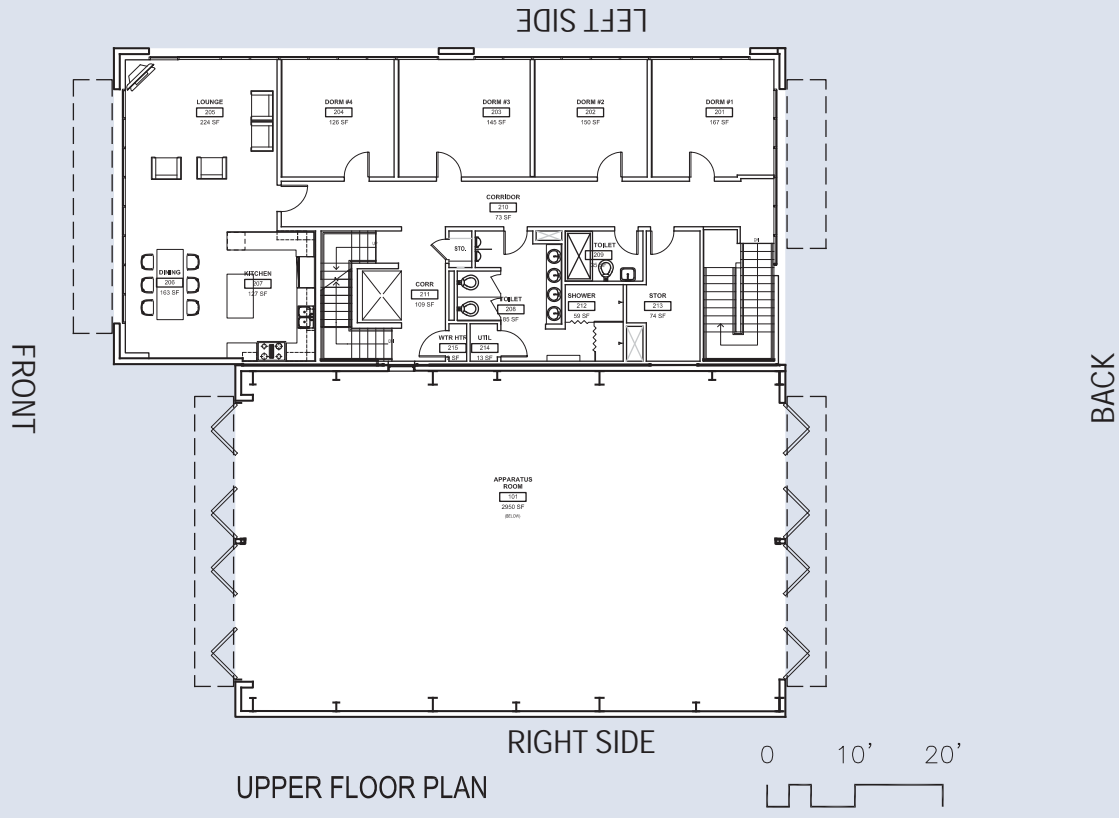

SK A3. (New site) Elevations

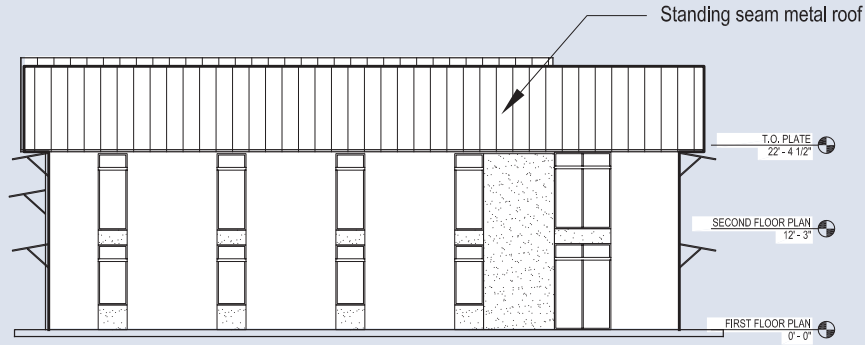

LEFT SIDE ELEVATION

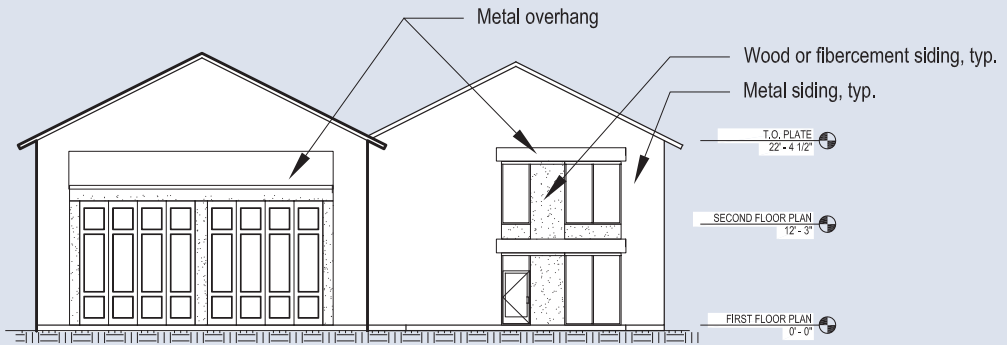

BACK ELEVATION

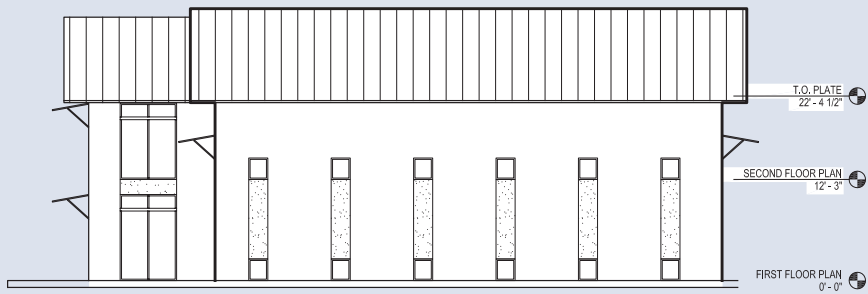

RIGHT SIDE ELEVATION



FRONT ELEVATION

SK B1.0 (Existing site through Phase 2) Site Plan

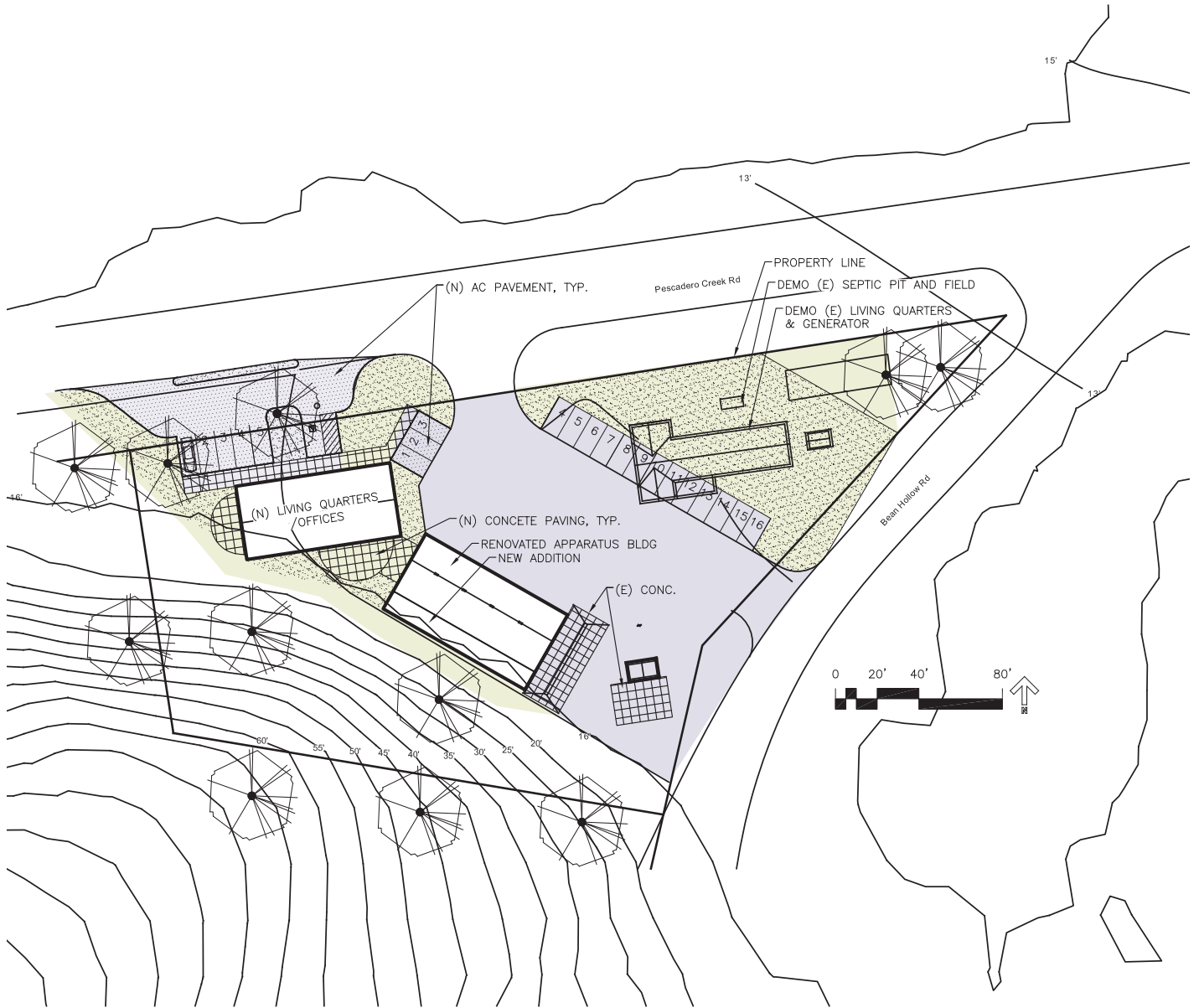

SK B1.1 (Existing site, Phase 1) new Living Quarters floor plan

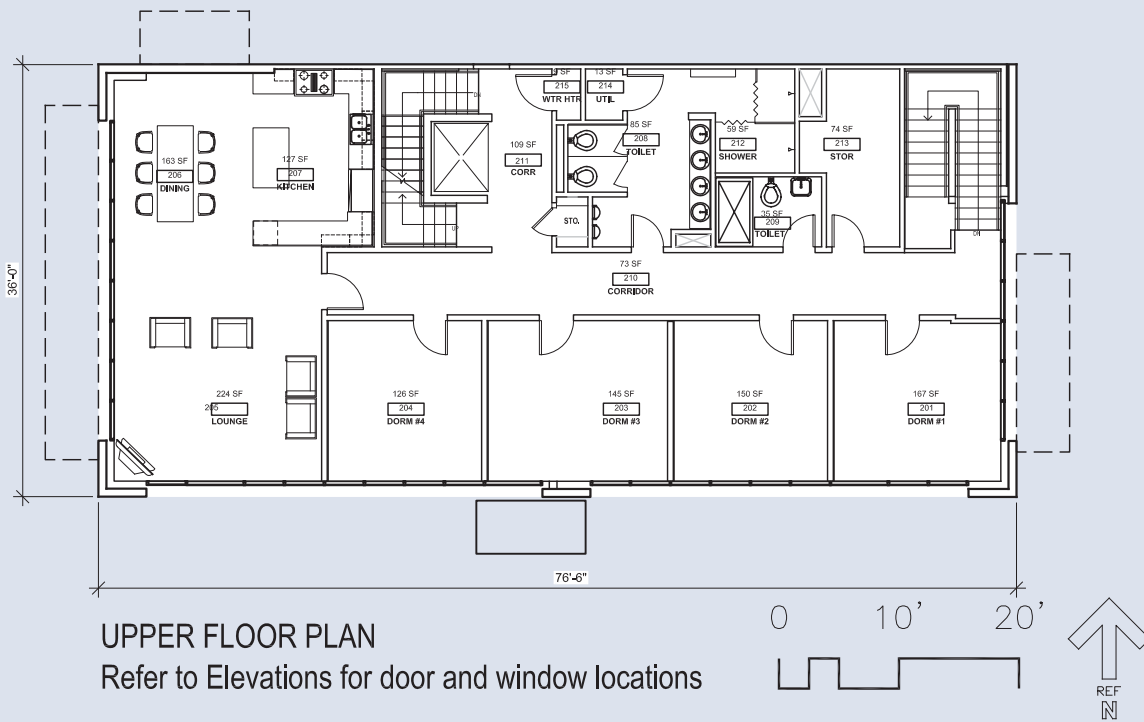
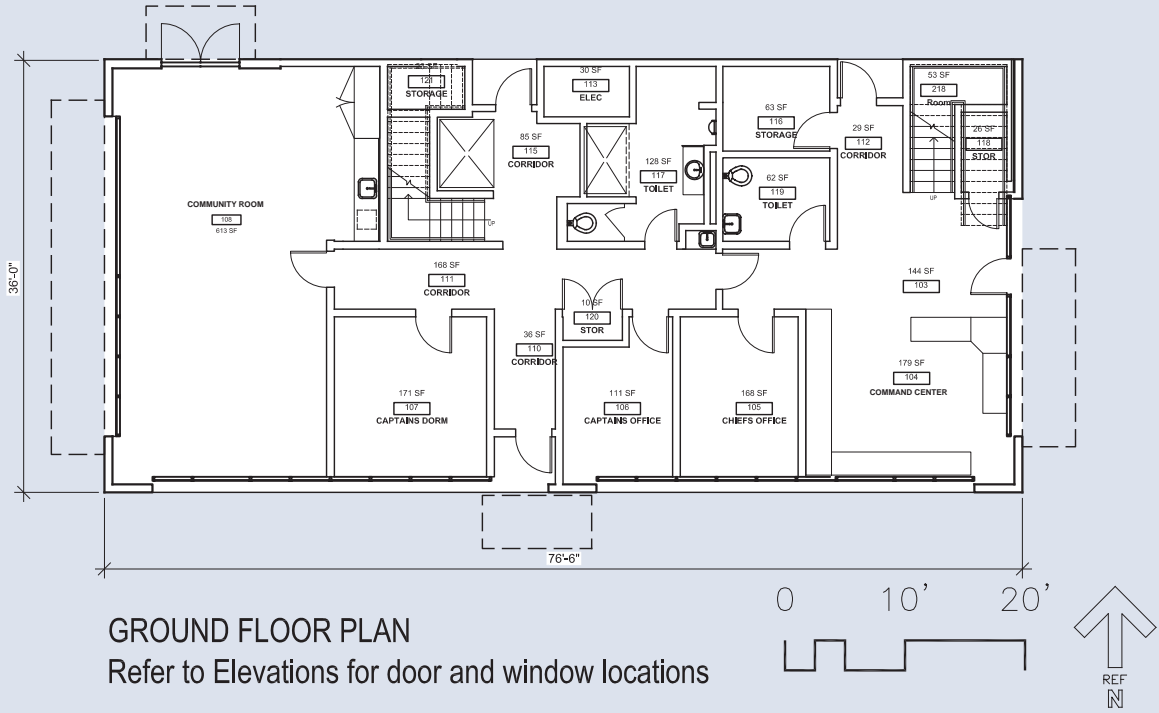

SK B1.2 (Existing site, Phase 1) new Living Quarters elevations

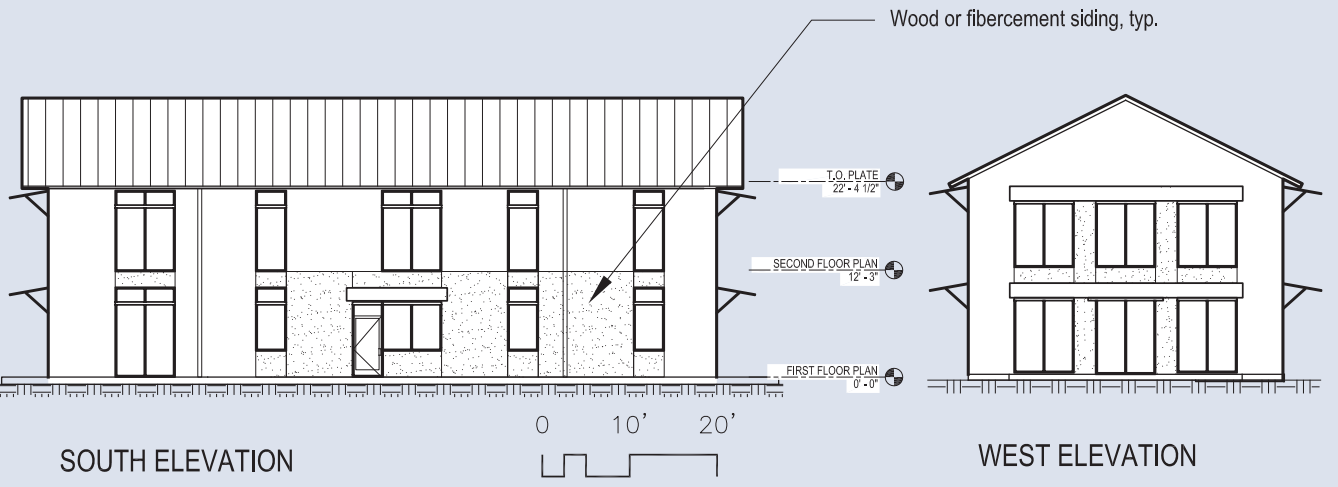
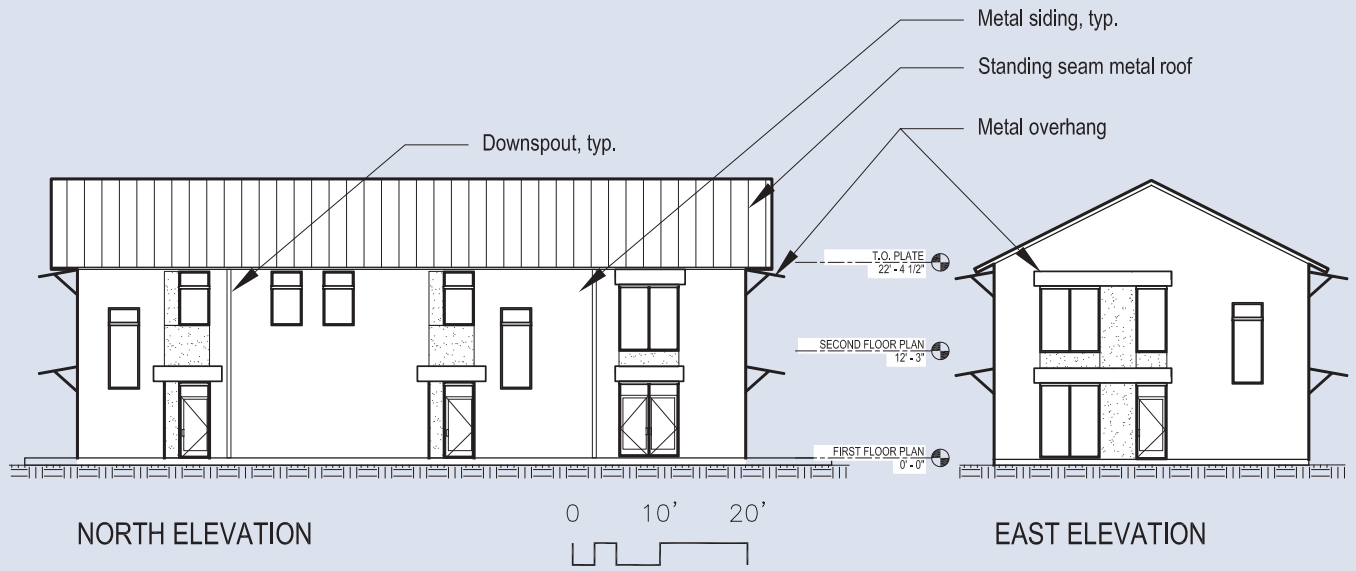

SK B2.1 (Existing site, Phase 2) Apparatus Building drawings

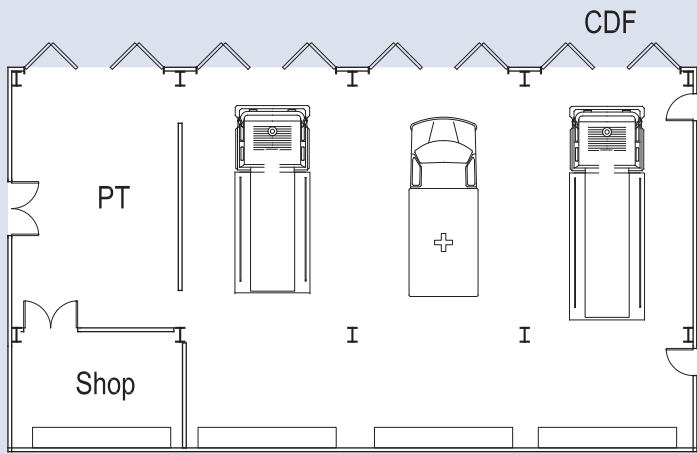

FLOOR PLAN

0 10' 20'

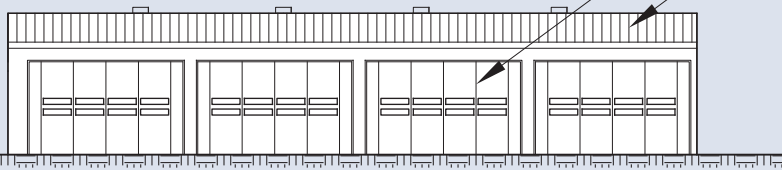

NORTH ELEVATION

0 10' 20'

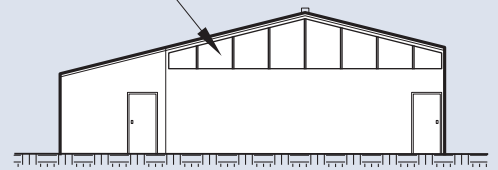

EAST ELEVATION

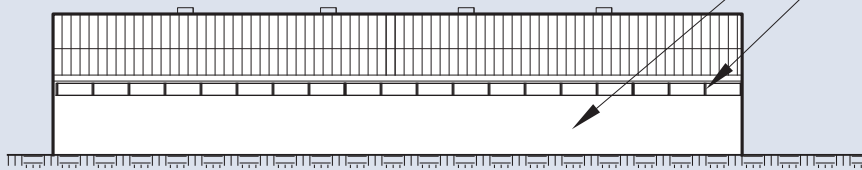

SOUTH ELEVATION

0 10' 20'

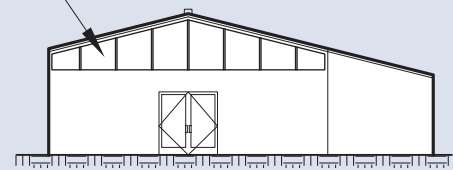

WEST ELEVATION

7. Cost Analysis

Options Analyzed

The project consists of Two Options:

Option A (New Site): Project consists of a new two-story 8,904 SF fire station with living quarters and apparatus bays. Sitework includes vehicular and pedestrian paving, landscaping, site lighting and drainage, new emergency generator and fuel storage tanks. Utilities include incoming water, storm drain and electrical service. Sewer is provide by an onsite septic system, gas is provided by propane tanks.

Option B (Existing Site): Project consists of replacing existing living quarters building with a new two-story 5,508 SF living quarters building, complete interior/exterior renovation to the existing 2,400 SF apparatus building, a new 1,100 SF addition to the existing apparatus building. Sitework includes vehicular and pedestrian paving, landscaping, site lighting and drainage, replacement of existing emergency generator and fuel storage tanks. Utilities include septic system replacement, distribution of utilities to buildings.

Cost summaries extracted from the full report are given on the following pages.

Basis for Pricing

Refer to full analysis given in Appendix 8.1. This estimate reflects the fair construction value for this project and should not be construed as a prediction of low bid. Subcontractor's markups have been included in each line item unit price. Subcontractor's markups typically range from 15% to 25% of the unit price depending on market conditions. This cost estimate is based on standard industry practice, professional experience and knowledge of the local construction market costs.

OVERALL SUMMARY OPTION A - NEW FIRESTATION AND SITE

BUILDING

Fire Station and Apparatus Bays	8,104	SF	2,779,194
Furniture, Fixtures and Equipment (FF&E)			See FF&E Budget

SITework

Site Preparation, Development and Utilities	1	LS	836,240
---	---	----	---------

DIRECT COSTS SUB-TOTAL			3,615,434
-------------------------------	--	--	------------------

SITE REQUIREMENTS AND JOBSITE MANAGEMENT (One Phase over 10 to 12 Months)	11.5%		415,775
--	-------	--	---------

ESTIMATE SUB-TOTAL			4,031,209
---------------------------	--	--	------------------

INSURANCE + BONDING	2.5%		100,780
FEE	3.0%		123,960

ESTIMATE SUB-TOTAL			4,255,949
---------------------------	--	--	------------------

DESIGN CONTINGENCY	15.0%		638,392
CONSTRUCTION CONTINGENCY	0.0%		Excluded

ESTIMATE SUB-TOTAL			4,894,341
---------------------------	--	--	------------------

ESCALATION (January 2015 start of Construction)	5.0%		244,717
---	------	--	---------

ESTIMATE TOTAL			5,139,058
-----------------------	--	--	------------------

OVERALL SUMMARY OPTION B - EXISTING FIRE STATION AND SITE

BUILDINGS

New Living Quarters	5,508	SF	1,759,001
Existing Apparatus Building Renovation	2,400	SF	867,100
Apparatus Building Addition	1,100	SF	259,600
Furniture, Fixtures and Equipment (FF&E)			See FF&E Budget
<i>Subtotal - Buildings</i>	9,008	SF	2,885,701

SITWORK

Site Preparation, Development and Utilities	1	LS	829,125
---	---	----	---------

DIRECT COSTS SUB-TOTAL 3,714,826

SITE REQUIREMENTS AND JOBSITE MANAGEMENT (Two Phases over 18 Months)	17.0%	631,520
---	-------	---------

ESTIMATE SUB-TOTAL 4,346,346

INSURANCE + BONDING	2.5%	108,659
FEE	4.5%	200,475

ESTIMATE SUB-TOTAL 4,655,480

DESIGN CONTINGENCY	15.0%	698,322
CONSTRUCTION CONTINGENCY	0.0%	Excluded

ESTIMATE SUB-TOTAL 5,353,802

ESCALATION (January 2015 start on Construction)	7.0%	374,766
---	------	---------

ESTIMATE TOTAL 5,728,568

8. Appendices

8.0 Water risks documentation

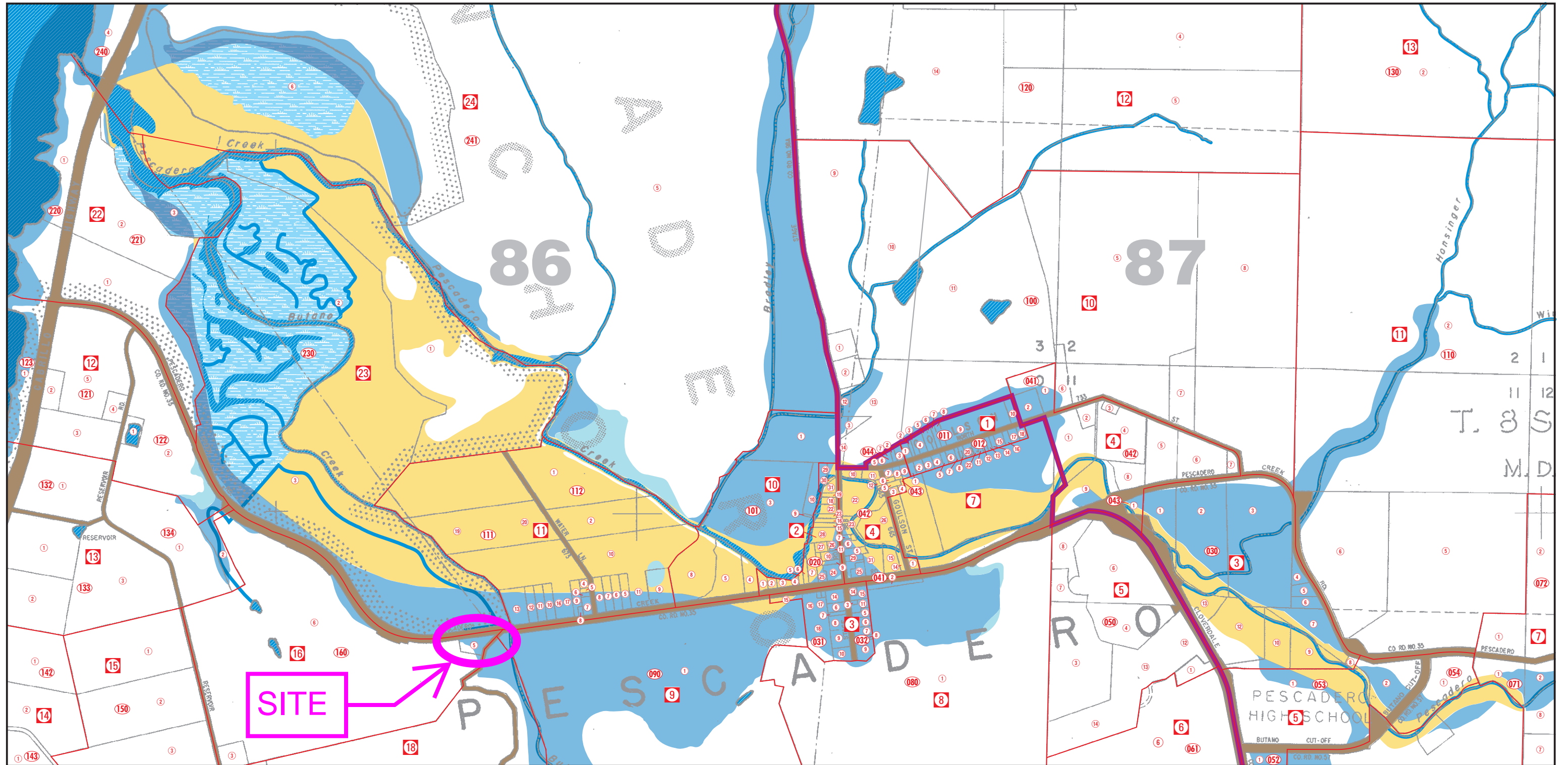

Pescadero Floodway Map

Disclaimer: The digital flood hazard data used on this map was derived from scanned and composited FEMA Floodway maps. The base cartographic map information was derived from a combination of Assessor and Public Works maps. For this reason and several others, including the scale or resolution that the information is displayed at, these maps should be considered an **advisory tool** for general hazard awareness, education, and flood plain management. This map is **not a legal document** to be used when making a single site flood hazard determination. That determination will have to be made by direct use of the FEMA FIRM or Floodway maps. (This is a non-archival inkjet print and is subject to fading when exposed to direct sunlight. Please store or display accordingly for maximum longevity.)

- Flood plain
- Floodway
- 500-yr Flood
- Lake

- Marshland
- Creeks; perenial
- Major Roads

- 87** Assessors book number
- Assessors book boundary
- Assessors page boundary

- Assessors page number
- Assessors block number
- Assessors parcel number





The Annual Flooding of Pescadero Creek Road

[Issue](#) | [Background](#) | [Findings](#) | [Conclusions](#) | [Recommendations](#) | [Responses](#) | [Attachments](#)

Issue

For over 25 years the main road into Pescadero has been blocked by the annual flooding of Butano Creek, jeopardizing public safety and impeding access by public safety officers and medical responders into and out of the Pescadero community. Why has the County not resolved this problem and how can it finally be fixed?

Summary

The blockage of Pescadero Creek Road, in the unincorporated community of Pescadero, happens one or more times each rainy season, often for days each time. Flooding jeopardizes the safety of local citizens in two primary ways: First, alternative routes into the Pescadero area are along much longer, narrower roadways requiring at least two to three times more driving time from the coastal highway. In the case of emergencies where the San Mateo County Sheriff, CAL FIRE or the California Highway Patrol is required, response time is critical and delays can impact personal safety of citizens and their property. Second, as the road floods, there are always some individuals who deliberately or inadvertently drive through the flooded road areas, sometimes successfully, sometimes not. A flooded road impacts local commerce, tourist traffic, and agribusiness in the area, and often leaves debris and silt to clean up.

The flooding is linked to decades of silt accumulation in the streambed, and excess vegetation growth and debris build-up along Butano Creek and in Pescadero Marsh. The drainage from the Marsh into the sea, and associated flushing of silt into the sea, is compromised by natural and man-made changes. These include logging debris, erosion, run-off, levees and channels built to facilitate agriculture, as well as certain now-abandoned modifications intended to correct watershed problems. The bottom line is that rains cannot be contained within Butano Creek's banks, resulting in predictable and dangerous road flooding.

The San Mateo County Civil Grand Jury recommends the removal of excess silt and clearance of vegetation overgrowth and debris from as much of the Butano Creek as necessary to eliminate the road flooding by October 1, 2012, before the 2012/2013 rainy season, using the regulatory framework of "Emergency" action if necessary.

Background

Since the 1880s, the town of Pescadero, population ~650, has been a farming and ranching community. The town is located at the upstream (eastern) edge of Pescadero Marsh, at the confluence of Pescadero and Butano Creeks, both of which empty into the Pacific.

The flooding of the Pescadero Creek Road at the Butano Creek Bridge closes the main route into and out of Pescadero, while simultaneously inundating privately owned farmlands. The road closure isolates the town and surrounding areas from its CAL FIRE Station, severely impacting emergency services. Alternate roads are small and winding through local hills. An ambulance, fire engine, or police vehicle could require an extra hour or more in transit time. In recent years, flooding has occurred several times during the rainy season, often for 24-48 hours at a time.

Several sources document the history and complexities of the Pescadero watershed.¹ The cause of the annual flooding includes progressive silt accumulation and vegetation overgrowth and debris build-up in Butano Creek up- and down-stream of the Bridge and beyond into the Marsh itself. Additionally, numerous property owners decades ago created levees and channels in the marsh for their land-uses, and several projects for the Coastal Highway have modified the seasonal sand-berm that affects the Butano Creek's flow from the Marsh to the Ocean. State regulations enacted beginning in the 1960s have prevented property owners from dredging and clearing creeks on their property and opening the sand-berm as they had historically done.²

Survey profiles demonstrate the silt build up. (*See*, Attachment A.) The streambed was ~12 feet below the bottom of the bridge in 1968.³ Currently the bridge clears the silted creek bottom by only two feet. The creek has no capacity to handle rainstorm run-off; the water has nowhere to go but up and over the road.

The California Department of State Parks and Recreation began acquiring Marsh properties in the 1960s, and in 1993 started to implement extensive modifications to the Marsh area intended to address and resolve environmental concerns⁴. Modifications included adding and removing dikes, adding water-control gates and culverts, and re-contouring certain flow features. The added features were not maintained, and were subsequently abandoned.⁵ The reasons for this abandonment have not been identified. As a result, silt-up and vegetation overgrowth has reduced the capacity and impeded the water flow in the Creek. Fish-kills within the Marsh have also increased; agribusiness has suffered; sport fishing has all but disappeared; and negative effects on endangered wildlife are being documented.⁶

Interviewees from local citizens' groups including the Pescadero Municipal Advisory Group (PMAC), the California Alliance for Species Enhancement (CASE), and the San Mateo County Farm Bureau have stated that State Parks' modifications have exacerbated the flooding. Scientists are mostly in agreement.⁷ For many years, citizens' groups have advocated County and State

¹ IDC, from Sans, Director DPW, to San Mateo County Planning Commission May 8, 1992, "Flooding of Butano Creek at Pescadero Road", and to Pescadero Community Council Nov 10, 1992; Pescadero-Butano Watershed Assessment, Final Report March 5, 2004, Environmental Science Associates.

² *See, e.g.*, California Fish and Game Code §§ 1600-1602.

³ *See*, Attachment A, "Silt-up Profiles."

⁴ Website, C.A.S.E., caseforourenvironment.org, August 2011, Example of Jerry Smith's 201995/6 SJSU studies, prepared for State Parks.

⁵ Interview, Biologist, NOAA / Fisheries.

⁶ Website, C.A.S.E., caseforourenvironment.org, Conditions in Pescadero Marsh, Lennie Roberts report, 2004.

⁷ Interview, scientist, California Dept. of Fish and Game.

action to provide relief from the flooding, and have proposed some immediate fixes. These included: dredging the streambed; raising the roadway at the bridge and especially at the low-point of the road; building a causeway and/or; installing a pump to move water from the upstream side of the bridge to a point downstream. None of these proposals have been implemented.

Permitting complexities can be additional barriers to immediate and broader County action. However, the Grand Jury is unaware that the County has actually applied for, or has been denied, any permits to address the road-flooding problem. The entities involved in permitting and advising permit issuance include State Parks, State Fish and Game, U.S. Fish and Wildlife Service, the Coastal Commission, and many others. (See, Attachment B: San Mateo County Public Works Permitting Flowchart.) A November 2010 letter from NOAA's National Marine Fisheries Service (NMFS) to California State Parks and Recreation and San Mateo County Public Works states that dredging may be a feasible solution to local road flooding, as well as alleviating the now encumbered fish passage (salmonids) until more extensive Marsh ecosystem recovery work is completed.⁸ It also advises that dredging permits from the State (if necessary) should not be a hindrance and that NOAA stands ready to work with State Parks and the County on such an effort. (See, Attachment C: NOAA letter to California State Parks and San Mateo County Dept. of Public Works.)

The responsibility for Pescadero Creek Road and its maintenance belongs to San Mateo County Public Works. Public Works is also responsible for a 30-ft right-of-way on either side of the road. Silt re-deposition, vegetation overgrowth, and debris collection likely would require limited periodic clearing and clean-up efforts in future years. From interviews, the Grand Jury learned that action has not been taken in part because of other priorities, political and jurisdictional disputes with other levels of State and Federal government as well as potential permitting complexities.

County officials and advisors have discussed the concept of "Emergency" public works action with the Grand Jury.⁹ The concept of "Emergency" action applies in two distinct circumstances. One is the declaration of a state of emergency by either a local government or the state, such as in 2010 when the San Bruno gas line exploded. The other involves conditions in which a local governmental entity, such as San Mateo County Public Works, can take emergency action to resolve an issue without the need to obtain prior permits to approve such actions. The permits in both circumstances may be resolved after the fact. Typically, Public Works has taken immediate action when necessary to repair roads/access due to slip-outs, rock-falls, flooding, under emergency authority, with permitting/remediation resolved after the fact.

California Government Code §21060.3 defines "Emergency" as a sudden, unexpected occurrence, involving a clear and imminent danger, demanding immediate action to prevent or mitigate loss of, or damage to, life, health, property, or essential public services. "Emergency"

⁸ Attachment B, Letter, NOAA / Fisheries to Public Works, and State Parks, November 24, 2010.

⁹ CEQA Cal Government Code §21060.3; Cal. Code of Regulations, §15269 (d).

includes such occurrences as fire, flood, earthquake or other soil or geologic movements, as well as such occurrences as riot, accident or sabotage.

The California Code of Regulations §15269 (Title 14, Ch. 3, Art. 18), Emergency Projects, exempts a series of emergency project types from the requirements of the California Environmental Quality Act (CEQA). Among them are:

(c) Specific actions necessary to prevent or mitigate an emergency. This does not include long term actions undertaken for the purpose of preventing or mitigating a situation that has a low probability of occurrence in the short-term.

In addition to the California Government Code reference cited above, there are other emergency provisions for waiving permits, allowing immediate actions to address issues of protecting life and public property from imminent danger, including fill and dredging activities under emergency conditions. Applicable references include:

- California Coastal Act: Public Resources Code § 30611 Emergencies; waiver of permit
- Local Coastal Program: SMC Local Coastal Program 9.15 Emergency Provisions
- US Army Corps of Engineers Regional General Permit 5 (emergency defined according to CEQA)¹⁰
- California Dept. of Fish and Game Code §1610 (a)(b)¹¹

Road flooding is one symptom of a deteriorating Marsh watershed. An integrated overall plan is necessary to identify engineering actions needed to address all the interactive elements of the Pescadero Marsh ecosystem. One initiative to develop an overall solution is now underway by the Resource Conservation District (RCD), chartered to advise the County on conservation and environmental issues. The RCD is a Special District of California and is appointed by and advisory to the San Mateo County Board of Supervisors. The RCD obtained funding in 2011 to conduct a study to explore lasting solutions for the Marsh watershed, including resolution of the road-flooding problem. The elapsed time for the RCD research study plus the resulting actual project work will take at least 5 years.

Investigation

To investigate Pescadero Creek flooding, the San Mateo Civil Grand Jury took site tours, reviewed documents and reports, and conducted interviews with Federal, State and County government personnel, and scientific and citizens' groups, including:

- San Mateo County Board of Supervisors
- San Mateo County Public Works
- San Mateo County Resource Conservation District (RCD)
- California State Fish and Game Department

¹⁰ <http://www.spn.usace.army.mil/regulatory/RGP/28218s.pdf> and http://ceres.ca.gov/ceqa/stat/Ch_2-5.html .

¹¹ <http://www.dfg.ca.gov/habcon/1600/1600code.html> .

- National Oceanic and Atmospheric Administration (NOAA / Fisheries)
- Committee for Green Foothills
- San Mateo County Farm Bureau
- Citizens Against Species Extinction (C.A.S.E.)
- Pescadero Municipal Advisory Council (PMAC)

Note that the Grand Jury attempted to interview two individuals from California State Parks and Recreation, the agency that owns the Marsh and is responsible for its management. The individuals first agreed, then later declined through their lawyers, to provide informational interviews to the Grand Jury on the subject of this Report. After substantial delay, the State's lawyers subsequently claimed that State Park and Recreation has "...very little specific knowledge about the impacts, the causes, or the responsibility for the flooding" and therefore would not allow its clients to be interviewed (even when written questions were tendered in advance). The Grand Jury is disappointed in the lack of cooperation and surprised by the claimed ignorance on the part of the public agency directly responsible for managing the Marsh. For the record, the Grand Jury considers the issuance of this Report to be only part of an open and continuing investigation of matters relating to road flooding, Butano Creek, and the Pescadero Marsh. The Grand Jury expressly reserves its right to request that a subpoena issue from the Superior Court compelling the attendance of and/or production of records before the Grand Jury from any witness. The Grand Jury continues to evaluate whether such steps are required in this matter.

Reference documents reviewed included public records and reports, relevant websites, County engineering and scientific documents and reports, and documents provided by or referenced by the interviewees.

Site tours included several walk-arounds of Butano Creek (at and around the Bridge) and the Marsh and its tributary creeks, as well as the estuary exit sand-berm along the coast.

Findings

The Grand Jury finds:

1. The Butano Creek overflows its banks and floods Pescadero Creek Road and surrounding farmland each year during periods of rains.
2. The flooding of Pescadero Creek Road at Butano Creek Bridge creates a dangerous setting and, when impassable, delays public safety access and virtually isolates a Pescadero community of approximately 650 people.
3. Silt accumulation, vegetation overgrowth, and debris have reduced flow capacity of Butano Creek and increased road flooding risk.
4. Butano Creek has not been thoroughly cleared of accumulated silt, vegetation overgrowth, or debris for decades.

5. California State Parks and Recreation, beginning in 1993, made extensive modifications in the Marsh to re-establish a “natural ecological environment.” Some modifications have not been maintained (e.g., flood gates) and, according to several interviewees, are presently ineffective and have made road-flooding conditions worse.
6. Solutions proposed to San Mateo County Public Works to correct the flooding include a raised roadway or a causeway, over-road pumping, dredging, and brush and debris clearance. The County has not adopted any of these suggestions.
7. San Mateo County is responsible for maintaining Pescadero Creek Road and its 30-foot right of way and therefore for correcting the road-flooding situation.
8. Multiple agencies, each with its own specific interests, might normally have to approve or advise on approval of permits to make changes that would resolve the flooding problem. Currently, any one agency could stop the process.
9. Multiple sections of California and federal law, e.g. California Fish and Game Code §1601, CEQA, CA Gov't Code §21060.3, and Cal. Code of Regs. §15269(d), provide for emergency exceptions to the permitting restrictions that normally apply to stream bed changes and road repairs. These may be available to Public Works to expedite actions that would eliminate Pescadero Road flooding.
10. The Grand Jury is unaware that the County has ever applied for, or been denied, any permit(s) for actions that would address the road flooding.
11. A November 24, 2010 letter from the NOAA’s National Marine Fisheries Service (NMFS) North Central Coast Office to California State Parks and San Mateo County Public Works expressed the view that the permits required to address the road flooding should not be a hindrance and that “NMFS stands ready to work with State Parks and the County toward the shared goal of resource protections while improving the safety of Pescadero Road.”
12. The Resource Conservation District has funding to explore solutions to environmental quality issues in the Pescadero Marsh ecosystem and intends to address Pescadero Creek Road flooding as part of its efforts. Its time frame, however, does not address the immediate need.

Conclusions

The Grand Jury concludes:

1. The status quo of annual road flooding is unsafe and unacceptable. The annual flooding of the main road serving Pescadero seriously jeopardizes citizens' safety, and impedes commercial activity in the area.
2. The diminishing capacity of the Butano Creek due to accumulated silt, vegetation

overgrowth, and debris increases the risk of flooding with lesser rainfall. This annual flooding is predictable and correctable.

3. The Board of Supervisors and responsible County government entities are essentially nonresponsive, hampered by other priorities, jurisdictional disputes with various State and Federal agencies, permitting requirements, and insufficient political will to overcome these.
4. The difficulty of obtaining approval of permits to address road flooding cannot be substantiated because, to the Grand Jury's knowledge, none have ever been applied for, or denied.
5. The Grand Jury believes that the County could invoke the "emergency repair" concept, take remedial action, and immediately end the Pescadero Creek Road flooding.
6. The estimated five years timing for any flood-control relief resulting from RCD's efforts is unacceptable.
7. Immediate solutions to road flooding must be implemented. The most promising include removal of excess silt and clearance of vegetation overgrowth and debris from as much of the Butano Creek as necessary to eliminate the annual road flooding.

Recommendations

The Grand Jury recommends that the Board of Supervisors:

1. Immediately direct the County Department of Public Works to remove excess silt and clear vegetation overgrowth and debris from as much of the Butano Creek as necessary to eliminate the road flooding. The work should be completed as soon as possible, and in all circumstances before October 1, 2012, the start of the 2012-13 rainy season. The intended result of this work is to prevent flooding of Butano Creek onto and around Pescadero Creek Road and farmlands.
2. Review the NOAA (NMFS) Nov 24, 2010 letter (*See*, Attachment B), and consult with NOAA and the San Mateo County RCD on strategies for expediting permit approvals, if any are required, to accomplish the work described in Recommendation 1.
3. If needed to accomplish Recommendation Number 1, use San Mateo County's authority under the various emergency provisions of California and/or federal law to take actions mitigating flooding to protect life or property.
4. Direct the San Mateo County Department of Public Works to periodically clean new silt, vegetation overgrowth, and debris from Butano Creek as needed to maintain flows and eliminate the recurrence of Pescadero Creek Road flooding.

Attachment A: Silt-up Profiles of Butano Creek Bridge

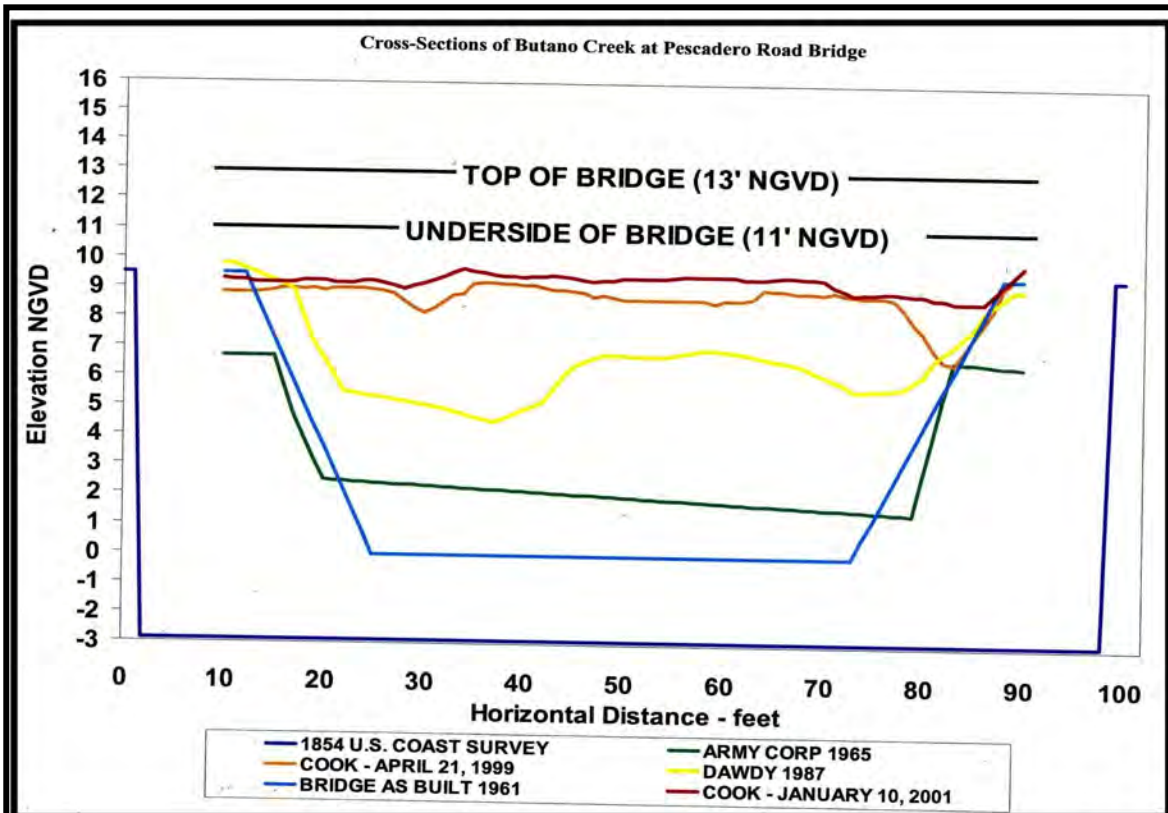

from
 "Restoration of
 Butano Creek"
 2001
 page 10

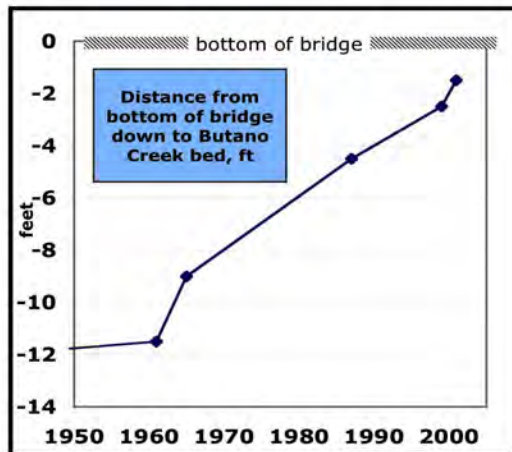

This image shows the profile of the Butano Creek streambed below the Pescadero Creek Road Bridge. Early surveys show the streambed some 12 feet below the bottom of the bridge. Today, the bridge clears the silted and debris-filled creek bottom by only 2 feet.

Attachment B:
San Mateo County Public Works Permitting Flowchart

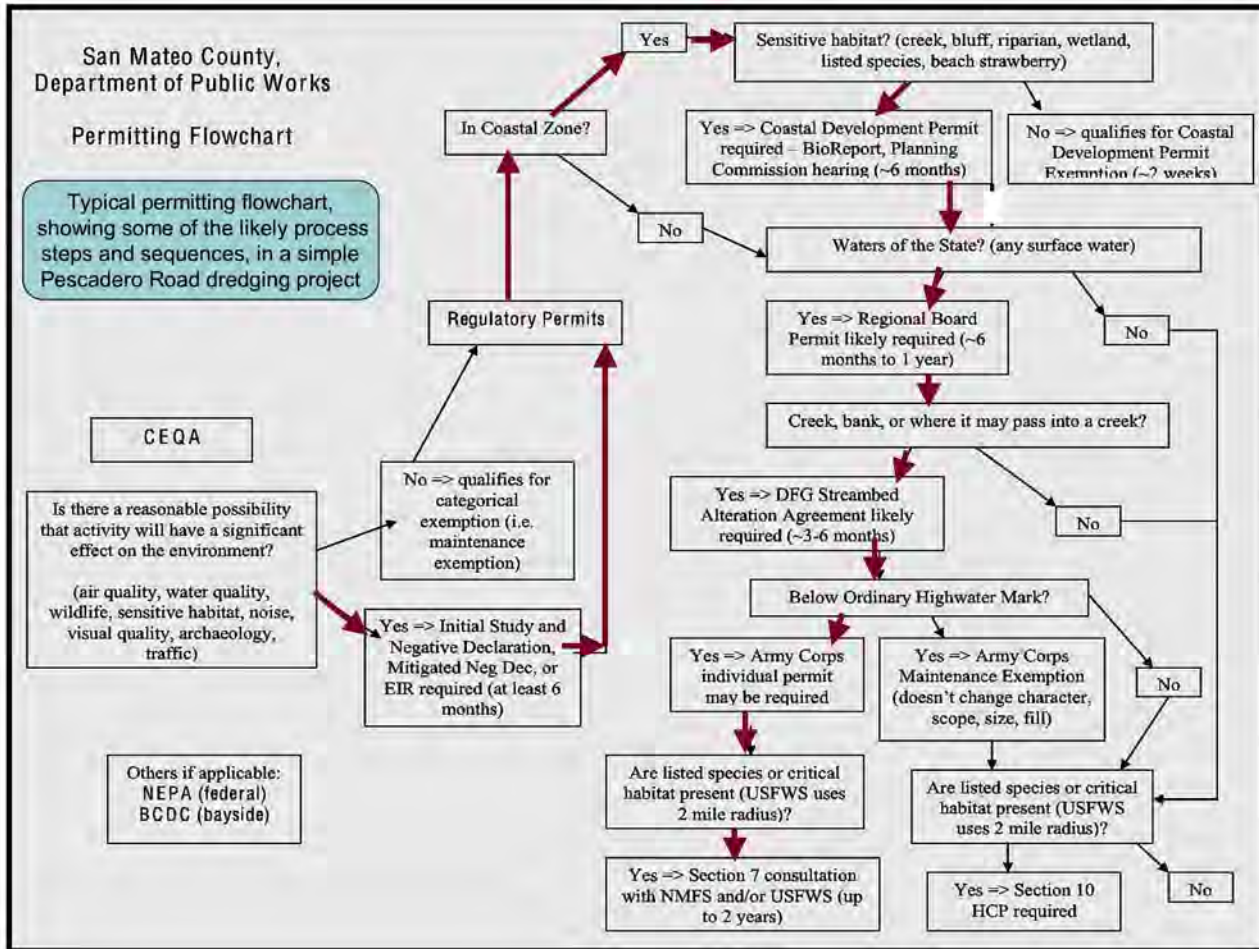

This flowchart, prepared by the San Mateo County Department of Public Works, illustrates the path and sequence for obtaining permit approval for relatively straightforward projects. It does not show the additional entities that, as a matter of course, provide technical input and guidance to the indicated permitters.

Attachment C: NOAA / Fisheries Letter

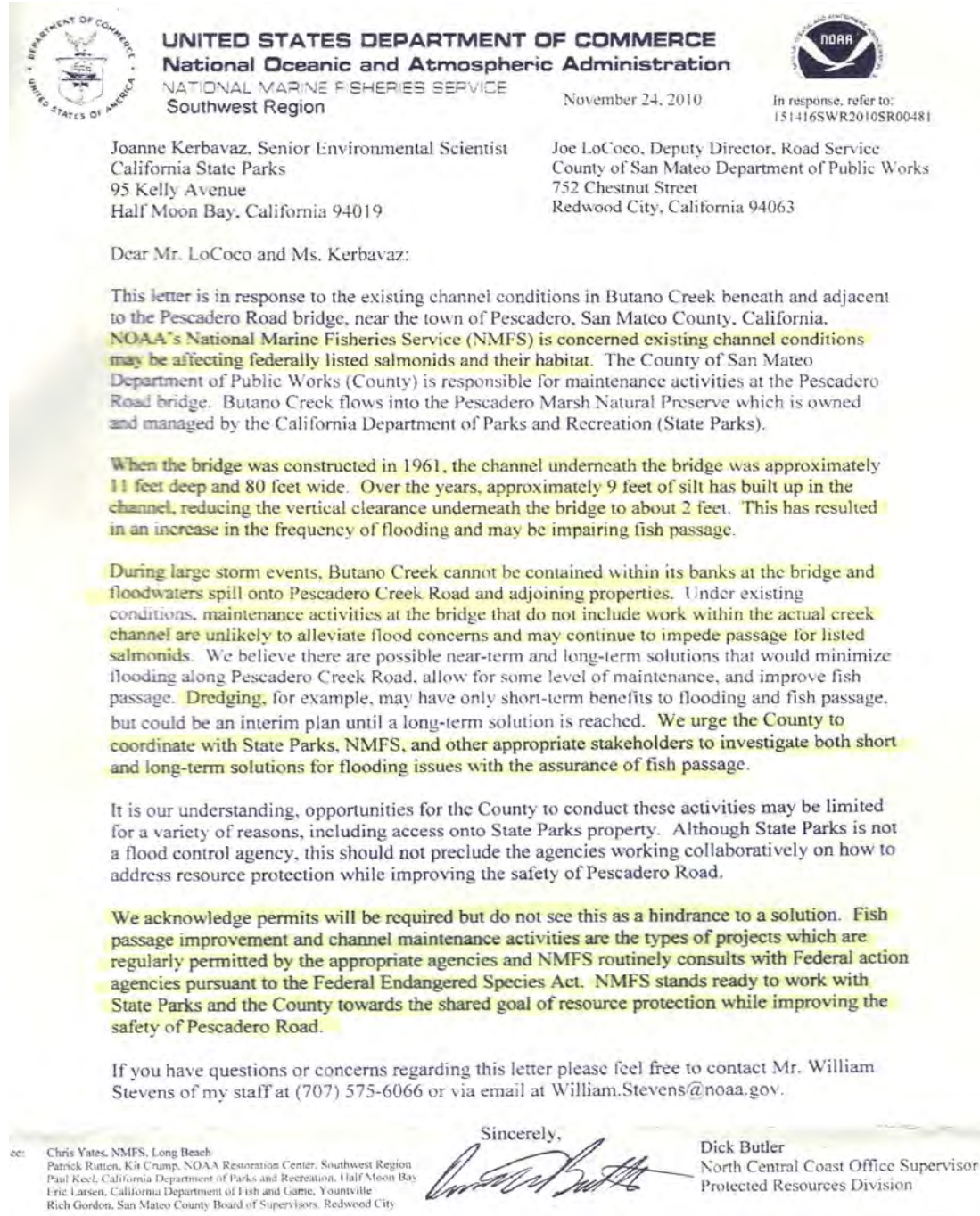

This letter from Mr. Butler of NOAA/Marine Fisheries, dated November 24, 2010, summarizes the silt-up of the Butano Creek streambed and its association with the annual Pescadero Road flooding. It acknowledges the potential interim benefits of dredging. It urges the County to coordinate with stakeholders to investigate solutions and provides guidance and offers support in overcoming permitting issues. *(highlights supplied)*.



COUNTY OF SAN MATEO
Inter-Departmental Correspondence
County Manager



Date: July 3, 2012
Board Meeting Date: July 24, 2012
Special Notice / Hearing: None
Vote Required: Majority

To: Honorable Board of Supervisors

From: John L. Maltbie

Subject: 2011-12 Grand Jury Response

RECOMMENDATION:

Approve the Board of Supervisors' response to the 2011-12 Grand Jury report titled: The Annual Flooding of Pescadero Creek Road.

BACKGROUND:

On March 1, 2012, the Grand Jury filed a report titled: The Annual Flooding of Pescadero Creek Road. A copy of the Grand Jury report is attached hereto and identified herein as Exhibit A. The Board of Supervisors is required to submit comments on the findings and recommendations pertaining to the matters under control of the County of San Mateo within ninety days. The County's response to the report is due to the Hon. Gerald J. Buchwald no later than July 30, 2012.

Acceptance of this report contributes to the Shared Vision 2025 outcome of a Collaborative Community by ensuring that all Grand Jury findings and recommendations are thoroughly reviewed by the appropriate County departments and that, when appropriate, process improvements are made to improve the quality and efficiency of services provided to the public and other agencies.

DISCUSSION:

The Annual Flooding of Pescadero Creek Road

Findings:

Grand Jury Finding Number 1. The Butano Creek overflows its banks and floods Pescadero Creek Road and surrounding farmland each year during periods of rains.

Response: Agree. Butano Creek (Creek) overflows its banks and floods Pescadero Creek Road in most years.

Grand Jury Finding Number 2. The flooding of Pescadero Creek Road at Butano Creek Bridge creates a dangerous setting and, when impassable, delays public safety access and virtually isolates a Pescadero community of approximately 650 people.

Response: Disagree in part. Depending on the severity of flooding, access to the community can be impacted. However, the community of Pescadero does not become isolated, as there are two additional, though more circuitous routes into and out of Pescadero that can be taken when Pescadero Creek Road is impacted. These routes include Stage Road, which provides access from the north, and Pescadero Creek Road which provides access from the east. In addition, prior to expected flood events, the County Fire engine at Pescadero moves from the station on the west side of the bridge to the east side, closer to town. Fire response and emergency response are therefore available to the community during flooding events.

Grand Jury Finding Number 3. Silt accumulation, vegetation overgrowth, and debris have reduced flow capacity of Butano Creek and increased road flooding risk.

Response: Disagree in part. It is not clear to what the “debris” reference refers to. Among other contributory flooding factors, silt accumulation and vegetation overgrowth within and adjacent to the Creek, have contributed to flow capacity restrictions within the channel. However, because the area downstream of the bridge and extending as far as the ocean is relatively flat, sediment will naturally accumulate along this section of Creek as long as a sediment source, such as the naturally occurring sandstone formations in the upper watershed, exists.

It is ultimately not clear to what extent these may be naturally occurring processes and to what extent they “have increased road flooding risk.” It is also not clear whether downstream restoration efforts or modifications to the Creek system have contributed to any issues associated with flooding..

Grand Jury Finding Number 4. Butano Creek has not been thoroughly cleared of accumulated silt, vegetation overgrowth, or debris for decades.

Response: Disagree in part. The Creek is lengthy and the Finding is not specific to a specific section of Creek. The County performed silt removal work within the Creek and Pescadero Creek Road right-of-way during the 1980’s and early 1990’s. Additionally, we understand that members of the Pescadero community removed woody debris, including beaver dams, in early 2000’s. The County of San Mateo has a limited road right of way along Pescadero Creek Road at the Creek, which is 100 feet wide, and is offset 40 feet approximately 40 feet at the middle of the bridge. With the right of way offset, the County actually has only approximately 60 feet of right of way that is uniformly under our control. Accounting for the width of the bridge (approx. 24 feet), we have full control of approximately 18 feet of channel on either side of the bridge. Silt removal performed by the County is generally limited to the section of Creek within the County’s right of way.

Grand Jury Finding Number 5. California State Parks and Recreation, beginning in 1993, made extensive modifications in the Marsh to re-establish a “natural ecological environment.” Some modifications have not been maintained (e.g., flood gates) and, according to several interviewees, are presently ineffective and have made road-flooding conditions worse.

Response: Disagree in part. California State Parks and Recreation has performed work within the Marsh. This includes installation of tidegates which we understand are not presently functioning. The specific interaction and effect of the Marsh on the Creek and flooding is not conclusive. Additionally, it has not been determined whether or not the tide gates have a direct effect on the flooding of Pescadero Creek Road.

Grand Jury Finding Number 6. Solutions proposed to San Mateo County Public Works to correct the flooding include a raised roadway or a causeway, over-road pumping, dredging, and brush and debris clearance. The County has not adopted any of these suggestions.

Response: Disagree in part. These have been “suggested solutions” communicated by the community. However, it has not been determined whether any of these “suggested solutions” would in fact eliminate the flooding of Pescadero Creek Road. A significant section of Pescadero Creek Road within the vicinity of the Creek is designated on the Federal Emergency Management Agency (FEMA) Flood Insurance Rate Maps as being subject to flooding. Flooding within the areas designated on the FEMA maps will always be a possibility.

Grand Jury Finding Number 7. San Mateo County is responsible for maintaining Pescadero Creek Road and its 30-foot right of way and therefore for correcting the road-flooding situation.

Response: Disagree. The County of San Mateo is responsible for maintaining constructed road infrastructure within the limits of its road right-of-way. The road right-of-way for Pescadero Creek Road is 100 feet wide at the bridge over the Creek and is offset by forty feet (40’) creating right of way limits that vary on each side of the bridge and Creek. The County of San Mateo does not have responsibility for areas outside of its road right of way (upstream or downstream of the bridge over the Creek), nor does it have responsibility for private property drainage. This Finding infers that the County has the responsibility to clear sediment or debris from the Creek upstream and downstream of the bridge to ensure that Pescadero Creek Road will not flood, which is not the case.

Grand Jury Finding Number 8. Multiple agencies, each with its own specific interests, might normally have to approve or advise on approval of permits to make changes that would resolve the flooding problem. Currently, any one agency could stop the process.

Response: Agree. The flooding that occurs on Pescadero Creek Road is a complex, multi-agency, and jurisdictional issue, which may potentially involve State and Federal agencies, the County, and private land owners. Not only are downstream solutions to be evaluated, but upstream property owners and land use must also be considered because the upstream properties are the source of sediment.

Grand Jury Finding Number 9. Multiple sections of California and federal law, e.g. California Fish and Game Code §1601, CEQA, CA Gov't Code §21060.3, and Cal. Code of Regs. §15269(d), provide for emergency exceptions to the permitting restrictions that normally apply to stream bed changes and road repairs. These may be available to Public Works to expedite actions that would eliminate Pescadero Road flooding.

Response: Disagree in part. There are in fact emergency exemptions which allow for after the fact permitting and would allow for expedited work. However, these exemptions generally pertain to situations where there is an immediate threat to public safety as a result of extreme natural events. On-going drainage issues within a designated area of flooding are generally not considered to be eligible for emergency permitting exemptions and would not be applicable to the flooding of Pescadero Creek Road.

Grand Jury Finding Number 10. The Grand Jury is unaware that the County has ever applied for, or been denied, any permit(s) for actions that would address the road flooding.

Response: Disagree. While a solution to the flooding issue has not been determined, the County of San Mateo has in the past applied for permits that would improve or restore localized drainage. Within the past year, the County received a permit to clear a culvert (pipe) along the south side of Pescadero Creek Road that flows to the south side of the bridge over the Creek. In addition, the County currently has a permit application pending for restoring the culvert capacity leading to the north side of the bridge.

Grand Jury Finding Number 11. A November 24, 2010 letter from the NOAA's National Marine Fisheries Service (NMFS) North Central Coast Office to California State Parks and San Mateo County Public Works expressed the view that the permits required to address the road flooding should not be a hindrance and that "NMFS stands ready to work with State Parks and the County toward the shared goal of resource protections while improving the safety of Pescadero Road."

Response: Disagree in part. NMFS is one regulatory agency among several that would be required to approve work in the Creek. NMFS regulates impacts to marine and anadromous wildlife, such as steelhead and Coho. Other agencies that would need to permit sediment removal from the Creek include: California Dept. of Fish and Game (regulates streambed alteration and species protection), California Regional Water Quality Control Board (regulates impacts to "Waters of the State" under Section 401 of the Clean Water Act), U.S. Army Corps of Engineers (regulates dredge and fill work

under Section 404 of the Clean Water Act and Section 10 of the Rivers and Harbors Act), and U.S. Fish and Wildlife Service (regulates terrestrial and freshwater species protection such as California red-legged frog and San Francisco garter snake). All agencies have agreed to work with the County and State Parks towards expediting permits once a project has been proposed. However, this does not mean that the regulatory agencies would allow the County or State Parks to do whatever is necessary to dredge the Creek. Any dredging of the Creek beyond the County road right-of-way would have potentially high impacts to existing dense riparian and wetland habitats, water quality, and endangered species. Any proposed dredging would require working closely with regulatory agencies to develop a plan to minimize those impacts to the maximum extent possible and mitigation for any impacts would likely be required.

Grand Jury Finding Number 12. The Resource Conservation District has funding to explore solutions to environmental quality issues in the Pescadero Marsh ecosystem and intends to address Pescadero Creek Road flooding as part of its efforts. Its time frame, however, does not address the immediate need.

Response: Disagree. The San Mateo County Resource Conservation District (SMCRCD) does not have funding to explore solutions to environmental quality issues in the Pescadero Marsh ecosystem. The SMCRCD provided the Pescadero Municipal Advisory Council, at their April 10, 2012 meeting, with a written description of the SMCRCD work as funded by a \$75,000 grant from the Bay Area Integrated Regional Water Management Plan through Proposition 84. The following includes excerpts from the written description as shown below in quotation marks.

“This project is to do the required analysis (most likely hydrology, hydraulics, refined sediment budget - not anything that has already been done but in some cases refining what has been done to a resolution required for permits) and develop consensus around an option or suite of options so that it is permit-ready and implementation-ready.”

“What it can do: Develop conceptual designs that are broadly supported by community members, landowners, and resource agencies, do the preliminary work for permit-readiness, include climate change considerations.”

“What it will not do: address flooding from mainstem Pescadero, complete designs, complete permits, construct solutions, presuppose a solution before the analysis has been completed.”

Recommendations:

1. Immediately direct the County Department of Public Works to remove excess silt and clear vegetation overgrowth and debris from as much of the Butano Creek as necessary to eliminate the road flooding. The work should be completed as soon as possible, and in all circumstances before October 1, 2012, the start of the 2012-13 rainy season. The

intended result of this work is to prevent flooding of Butano Creek onto and around Pescadero Creek Road and farmlands.

Response:

This recommendation requires further analysis, as it has not been determined how dredging would affect riparian and wetland habitat, sensitive species, or adjacent properties. Furthermore, the County of San Mateo has no authority to enter onto private property to perform work of any kind absent a mutual agreement to do so with landowners, and we do not believe that dredging within the 100 feet of County right of way will relieve flooding.

It has also not been determined that dredging is the optimal solution to preventing flooding of Pescadero Creek Road from the Creek. While dredging the Creek has been suggested, there has been no analysis of the impacts of dredging on surrounding lands. It has been reported that the Creek does not have a defined channel approximately 1,000 feet downstream of the Pescadero Creek Road Bridge. Thus, it is not clear whether it is possible to dredge “as much of the Butano Creek as necessary to eliminate the road flooding.” The fact that the area is in a defined flood plain suggests that dredging of the creek to eliminate flooding is not in fact achievable. We also do not believe an October 1, 2012 timeframe is plausible for any work involving the Creek. Our experience has been that permit approvals can be expected to take more than one year to obtain in instances such as these where many permit approvals are required to assure that the water quality, sensitive habitats, and protected species are not adversely impacted.

As mentioned above in the Response to Finding 12, the SMCRCD is currently working on a grant funded project which would provide additional site analysis. It is believed that such an analysis will help establish potential solutions to the localized flooding. The County has been in contact with the SMCRCD regarding the possibility of supporting an expanded study by the SMCRCD that would include an analysis of the impacts associated with Creek dredging efforts.

In addition, County staff are working on ways to reduce the danger to the community during flooding by posting electronic message signs on either side of the flood prone area near the bridge. This will not solve the long term flooding problem, but will clearly inform the drivers that the bridge is flooded and hopefully reduce the danger to drivers in the near term. (Are these the measures being considered?)

2. Review the NOAA (NMFS) Nov 24, 2010 letter (See, Attachment B), and consult with NOAA and the San Mateo County RCD on strategies for expediting permit approvals, if any are required, to accomplish the work described in Recommendation 1.

Response:

This recommendation requires further analysis; however, the County has been in contact with NMFS, the SMCRCD, other pertinent regulatory agencies, and State representatives regarding the issues surrounding the Creek, Pescadero Creek Road,

and the Marsh. As stated in the Response to Finding 11, multiple permits or approvals would be required to perform dredging or any work in or near the Creek. The additional site analysis which is to be performed by the SMCRCD through the grant funding is generally considered the next key step in identifying potential flood mitigation solutions. To the extent that the SMCRCD study could be expanded to include levels of detail that would allow for a complete site analysis, the County intends to prepare a comprehensive report during FY 2012/13 which can be utilized as a baseline for the development of solutions to reduce the flooding of Pescadero Creek Road from the Creek. Through discussions with the various permitting agencies, there has been general agreement among the agencies to expedite their reviews.

3. If needed to accomplish Recommendation Number 1, use San Mateo County's authority under the various emergency provisions of California and/or federal law to take actions mitigating flooding to protect life or property.

Response:

This recommendation will not be implemented because it is not feasible. The County's Department of Public Works, works closely with regulatory agencies on numerous projects every year and has had discussions with the various agencies with respect to this and other projects. We have confirmed at several levels that work within the Creek channel would not be considered by the regulatory agencies as emergency work and would therefore require standard reviews and permit approvals. We are, however, continuing to investigate whether there may be FEMA funding opportunities through CalEMA and whether these programs offer opportunities for expedited work approvals.

4. Direct the San Mateo County Department of Public Works to periodically clean new silt, vegetation overgrowth, and debris from Butano Creek as needed to maintain flows and eliminate the recurrence of Pescadero Creek Road flooding.

Response:

This recommendation requires further analysis. As noted in the Response to Recommendation 1, it has not been determined that dredging the Creek is a feasible short term or long term solution to flooding. The County currently has plans to perform an engineering analysis that would consider the effectiveness of potential alternatives, including dredging within the Pescadero Creek Road right-of-way and beyond. We are planning on prioritizing such studies and anticipate that they will be completed within the next fiscal year. Regular and periodic removal of silt, vegetation, and debris from the Creek would require permits from the regulatory agencies.

FISCAL IMPACT:

There is no Net County Cost associated with accepting this report.

8.1 Cost Analysis

Pescadero Fire Station

Pescadero, California

January 14, 2014



1663 Eureka Road
Roseville, CA 95661
(916) 742-1770
www.tbdconsultants.com

Prepared for:
Ratcliff Architects
5856 Doyle Drive
Emeryville, CA 94608
(510) 899-6400

CONTENTS	PAGE NO.	PAGE Nos.
Basis of Estimate		1 - 2
Overall Summary Option A - New Fire Station and Site		3
Overall Summary Option B - Existing Fire Station and Site		4
Budget Estimates		
New Fire Station		5 - 7
Living Quarters		8 - 10
Existing Apparatus Building Renovation		11 - 12
Apparatus Building Addition		13 - 14
New Site		15 - 16
Existing Site		17 - 18

PROJECT DESCRIPTION

The project consists of Two Options:

Option A (New Site): Project consists of a new two-story 8,104 SF fire station with living quarters and apparatus bays. Sitework includes vehicular and pedestrian paving, landscaping, site lighting and drainage, new emergency generator and fuel storage tanks. Utilities include incoming water, storm drain and electrical service. Sewer is provide by an onsite septic system, gas is provided by propane tanks.

Option B (Existing Site): Project consists of replacing existing living quarters building with a new two-story 5,508 SF living quarters building, complete interior/exterior renovation to the existing 2,400 SF apparatus building, a new 1,100 SF addition to the existing apparatus building. Sitework includes vehicular and pedestrian paving, landscaping, site lighting and drainage, replacement of existing emergency generator and fuel storage tanks. Utilities include septic system replacement, distribution of utilities to buildings.

REFERENCE DOCUMENTATION

Documents provided by Ratcliff Architects and their Design Team.

SITE VISIT

Meeting and site visit November 20, 2013.

BASIS FOR PRICING

This estimate reflects the fair construction value for this project and should not be construed as a prediction of low bid. Prices are based on local prevailing wage construction costs at the time the estimate was prepared. Pricing assumes a procurement process with competitive bidding for all sub-trades of the construction work, which is to mean a minimum of 3 bids for all subcontractors and materials/equipment suppliers. If fewer bids are solicited or received, prices can be expected to be higher.

Subcontractor's markups have been included in each line item unit price. Markups cover the cost of field overhead, home office overhead and subcontractor's profit. Subcontractor's markups typically range from 15% to 25% of the unit price depending on market conditions.

General Contractor's/Construction Manager's Site Requirement costs are calculated on a percentage basis. General Contractor's/Construction Manager's Jobsite Management costs are also calculated on a percentage basis.

General Contractor's/Construction Manager's overhead and fees are based on a percentage of the total direct costs plus general conditions, and covers the contractor's bond, insurance, site office overheads and profit.

Unless identified otherwise, the cost of such items as overtime, shift premiums and construction phasing are not included in the line item unit price.

BASIS OF ESTIMATE

This cost estimate is based on standard industry practice, professional experience and knowledge of the local construction market costs. TBD Consultants have no control over the material and labor costs, contractors methods of establishing prices or the market and bidding conditions at the time of bid. Therefore TBD Consultants do not guarantee that the bids received will not vary from this cost estimate.

CONTINGENCY

Design Contingency **15%**

The Design Contingency is carried to cover scope that lacks definition and scope that is *anticipated* to be added to the Design. As the Design becomes more complete the Design Contingency will reduce.

Construction Contingency **0%** ***to be carried elsewhere in Owner's Budget***

The Construction Contingency is carried to cover the unforeseen during construction execution and Risks that do not currently have mitigation plans. As Risks are mitigated, Construction Contingency can be reduce, but should not be eliminated.

ESCALATION

Escalation has been included based on a January 2015 start of construction.

EXCLUSIONS

- Land acquisition, feasibility, and financing costs
- All Owner soft costs
- All professional fees and insurance
- Construction Manager or Agency Costs
- Site or existing condition survey investigation costs, including determination of subsoil conditions
- Hazardous materials inspection costs, or accommodations in construction for hazardous materials.
- Owners Construction Contingency for scope changes and market conditions at time of bid
- Permits

ITEMS THAT MAY AFFECT THIS ESTIMATE

Such items include, but are not limited to the following:

- Modifications to the scope of work subsequent to the preparation of this estimate
- Unforeseen existing conditions
- Compression of planned construction schedule
- Special requirements for site access or off-hours work
- Restrictive technical specifications, excessive contract or non-competitive bid conditions
- Sole source specifications for materials, products or equipment
- Bid approvals delayed beyond the anticipated project schedule

OVERALL SUMMARY OPTION A - NEW FIRESTATION AND SITE

BUILDING

Fire Station and Apparatus Bays	8,104	SF	2,779,194
Furniture, Fixtures and Equipment (FF&E)			See FF&E Budget

SITWORK

Site Preparation, Development and Utilities	1	LS	836,240
---	---	----	---------

DIRECT COSTS SUB-TOTAL			3,615,434
-------------------------------	--	--	------------------

SITE REQUIREMENTS AND JOBSITE MANAGEMENT (One Phase over 10 to 12 Months)	11.5%		415,775
--	-------	--	---------

ESTIMATE SUB-TOTAL			4,031,209
---------------------------	--	--	------------------

INSURANCE + BONDING	2.5%		100,780
FEE	3.0%		123,960

ESTIMATE SUB-TOTAL			4,255,949
---------------------------	--	--	------------------

DESIGN CONTINGENCY	15.0%		638,392
CONSTRUCTION CONTINGENCY	0.0%		Excluded

ESTIMATE SUB-TOTAL			4,894,341
---------------------------	--	--	------------------

ESCALATION (January 2015 start of Construction)	5.0%		244,717
---	------	--	---------

ESTIMATE TOTAL			5,139,058
-----------------------	--	--	------------------

OVERALL SUMMARY OPTION B - EXISTING FIRE STATION AND SITE

BUILDINGS

New Living Quarters	5,508	SF	1,759,001
Existing Apparatus Building Renovation	2,400	SF	867,100
Apparatus Building Addition	1,100	SF	259,600
Furniture, Fixtures and Equipment (FF&E)			See FF&E Budget
<i>Subtotal - Buildings</i>	9,008	SF	2,885,701

SITWORK

Site Preparation, Development and Utilities	1	LS	829,125
---	---	----	---------

DIRECT COSTS SUB-TOTAL			3,714,826
-------------------------------	--	--	------------------

SITE REQUIREMENTS AND JOBSITE MANAGEMENT (Two Phases over 18 Months)	17.0%		631,520
---	-------	--	---------

ESTIMATE SUB-TOTAL			4,346,346
---------------------------	--	--	------------------

INSURANCE + BONDING	2.5%		108,659
FEE	4.5%		200,475

ESTIMATE SUB-TOTAL			4,655,480
---------------------------	--	--	------------------

DESIGN CONTINGENCY	15.0%		698,322
CONSTRUCTION CONTINGENCY	0.0%		Excluded

ESTIMATE SUB-TOTAL			5,353,802
---------------------------	--	--	------------------

ESCALATION (January 2015 start on Construction)	7.0%		374,766
---	------	--	---------

ESTIMATE TOTAL			5,728,568
-----------------------	--	--	------------------

REF	DESCRIPTION	QUANTITY	UoM	UNIT RATE	TOTAL	COMMENTS
STRUCTURE						
<u>Building Pad</u>						
	Built-up building pad - allow	7,200	SF	2.50	18,000	
<u>Foundations</u>						
	Perimeter wall footing	340	LF	100.00	34,000	
	Column footings	30	EA	650.00	19,500	
	Interior grade beams - allow	1	LS	10,000.00	10,000	
	Elevator pit - single	1	EA	10,000.00	10,000	
<u>Vertical Structure</u>						
	Steel columns and moment frames - allow 6.00#/SF	25	TN	4,500.00	112,500	
<u>Floor and Roof Structure</u>						
Slab on grade including base						
	Living quarters	2,754	SF	10.00	27,540	
	Apparatus	2,596	SF	14.00	36,344	
Steel framed floor structure including metal decking and concrete topping - allow 8.00#/SF						
		2,754	SF	30.00	82,620	
Steel framed pitched roof structure and roof overhangs including metal decking - allow						
	Living quarters	3,360	SF	25.00	84,000	
	Apparatus - long span	3,100	SF	30.00	93,000	
	Wall curbs, equipment pads and curbs	1	LS	10,000.00	10,000	
	Miscellaneous metals and rough carpentry	8,104	SF	3.00	24,312	
	Seismic joints between living quarters and apparatus building	1	LS	10,000.00	10,000	
	Fireproofing steelwork - not required				NIC	
STRUCTURE					571,816	
EXTERIOR WALLS AND ROOFING						
<u>Exterior Walls</u>						
Steel stud framed exterior walls with plywood sheathing						
		6,900	SF	16.00	110,400	
Metal/wood siding, batt insulation, gypsum board and paint to interior face of exterior wall						
		6,900	SF	25.00	172,500	
	Operable windows (allow 25% of exterior walls)	1,700	SF	80.00	136,000	
	Shade structures at windows - allow	1	LS	10,000.00	10,000	
	Soffits/roof overhangs	1,200	SF	25.00	30,000	
	Entrance doors and service doors	1	LS	20,000.00	20,000	
	Apparatus bi-fold doors - motorized	4	EA	30,000.00	120,000	
	Fascia's, trim and ornamentation	1	LS	20,000.00	20,000	
	Entrance canopy or covered porch	1	LS	10,000.00	10,000	
	Louvers and vents	1	LS	3,000.00	3,000	
<u>Outdoor Patio</u>						
	Concrete paving	240	SF	15.00	3,600	
Roof structure including structure and metal roofing						
		240	SF	75.00	18,000	
<u>Roofing</u>						
Metal roofing including insulation and flashing						
		6,460	SF	25.00	161,500	
	Gutters and downspouts	1	LS	10,000.00	10,000	
	Miscellaneous flashing, caulking and sealants	1	LS	8,000.00	8,000	
	Skylights - not required				NIC	
EXTERIOR WALLS AND ROOFING					833,000	

REF	DESCRIPTION	QUANTITY	UoM	UNIT RATE	TOTAL	COMMENTS
INTERIOR CONSTRUCTION						
<u>Interior Partitions</u>						
	Metal stud partitions including sound insulation, gypsum board and paint finish	4,200	SF	15.00	63,000	
	Interior doors -allow	26	EA	2,000.00	52,000	
<u>Interior Finishes</u>						
<u>Flooring including base</u>						
	Carpet and vinyl	5,108	SF	8.00	40,864	
	Ceramic tile	400	SF	22.00	8,800	
	Sealer	2,596	SF	2.50	6,490	
<u>Walls</u>						
	Ceramic tile	1,200	SF	20.00	24,000	
	Painted plywood panels at apparatus room	1,500	SF	8.00	12,000	
	Miscellaneous wall finishes - allow	1	LS	15,000.00	15,000	
<u>Ceilings</u>						
	Suspended acoustical tile and gypsum board ceilings	8,104	SF	10.00	81,040	
<u>Equipment</u>						
<u>Kitchen</u>						
	Base cabinet including countertop	30	LF	450.00	13,500	
	Upper wall cabinet	20	LF	200.00	4,000	
	Island	1	EA	3,000.00	3,000	
	Appliances	1	LS	20,000.00	20,000	
<u>Restrooms</u>						
	Vanities	10	LF	300.00	3,000	
	Shower stalls	3	EA	1,500.00	4,500	
	Partitions and accessories	1	LS	6,000.00	6,000	
<u>Offices, meeting room and training room</u>						
	Built-in casework - allow	1	LS	10,000.00	10,000	
	Equipment and accessories	1	LS	10,000.00	10,000	
	Wardrobe lockers - allow	13	EA	1,200.00	15,600	
	Restroom lockers - allow	13	EA	600.00	7,800	
	Turn-out lockers - allow	24	EA	800.00	19,200	
	Casework and workbench at apparatus room	1	LS	10,000.00	10,000	
	Laundry room casework, washer and dryer	1	LS	6,000.00	6,000	
	Shelving, wall guards and corner guards	1	LS	5,000.00	5,000	
	Window blinds or shades	1,700	SF	7.00	11,900	
	Signage and graphics (interior and exterior)	1	LS	10,000.00	10,000	
	Miscellaneous equipment and accessories	1	LS	15,000.00	15,000	
	Furniture, beds and moveable furnishings - FF&E Budget				FF&E Budget	
<u>Vertical Transportation</u>						
	Elevator- two stop hydraulic including shaft walls and associated mechanical and electrical requirements	1	EA	100,000.00	100,000	
	Stair including railings	2	EA	15,000.00	30,000	
INTERIOR CONSTRUCTION					607,694	
MECHANICAL, ELECTRICAL, PLUMBING, FIRE PROTECTION						
<u>Plumbing</u>						
	Plumbing system	8,104	SF	18.50	149,924	
<u>Heating and Ventilation</u>						
	Heating and ventilation system (no air conditioning)	8,104	SF	16.00	129,664	
	Vehicle exhaust system (2 bays)	1	LS	90,000.00	90,000	
<u>Electrical</u>						
	Electrical system including power, lighting, alarm systems and communications	8,104	SF	44.00	356,576	

REF	DESCRIPTION	QUANTITY	UoM	UNIT RATE	TOTAL	COMMENTS
	<u>Fire Protection</u>					
	Fire sprinkler system	8,104	SF	5.00	40,520	
MECHANICAL, ELECTRICAL, PLUMBING, FIRE PROTECTION					766,684	
SELECTIVE BUILDING DEMOLITION / TEMPORARY WORK						
	No work anticipated					
SELECTIVE BUILDING DEMOLITION / TEMPORARY WORK						
SITE WORK						
	See Site Work Estimate					Site Work
SITE WORK						
DIRECT COSTS SUB-TOTAL					2,779,194	

Two-Story Living Quarters Building (5,508 SF)

REF	DESCRIPTION	QUANTITY	UoM	UNIT RATE	TOTAL	COMMENTS
STRUCTURE						
<u>Building Pad</u>						
	Built-up building pad - allow	4,000	SF	3.00	12,000	
<u>Foundations</u>						
	Perimeter wall footing	220	LF	100.00	22,000	
	Column footings	15	EA	650.00	9,750	
	Interior grade beams - allow	1	LS	5,000.00	5,000	
	Elevator pit - single	1	EA	10,000.00	10,000	
<u>Vertical Structure</u>						
	Steel columns and moment frames - allow 6.00#/SF	17	EA	4,500.00	76,500	
<u>Floor and Roof Structure</u>						
	Slab on grade including base	2,754	SF	10.00	27,540	
	Steel framed floor structure including metal decking and concrete topping - allow 8.00#/SF	2,754	SF	30.00	82,620	
	Steel framed pitched roof structure and roof overhangs including metal decking - allow 8.00#/SF	3,360	SF	25.00	84,000	
	Miscellaneous metals and rough carpentry	5,508	SF	3.00	16,524	
	Wall curbs, equipment pads and curbs	1	LS	5,000.00	5,000	
	Fireproofing steelwork - not required				NIC	
STRUCTURE					350,934	
EXTERIOR WALLS AND ROOFING						
<u>Exterior Walls</u>						
	Steel stud framed exterior walls with plywood sheathing	4,500	SF	16.00	72,000	
	Metal/wood siding, batt insulation, gypsum board and paint to interior face of exterior wall	4,500	SF	25.00	112,500	
	Operable windows (allow 25% of exterior walls)	1,125	SF	80.00	90,000	
	Shade structures at windows - allow	1	LS	10,000.00	10,000	
	Soffits/roof overhangs	600	SF	25.00	15,000	
	Entrance doors and service doors	1	LS	15,000.00	15,000	
	Fascia's, trim and ornamentation	1	LS	10,000.00	10,000	
	Entrance canopy or covered porch	1	LS	10,000.00	10,000	
<u>Outdoor Patio</u>						
	Concrete paving	240	SF	15.00	3,600	
	Roof structure including structure and metal roofing	240	SF	75.00	18,000	
<u>Roofing</u>						
	Metal roofing including insulation and flashing	3,360	SF	25.00	84,000	
	Gutters and downspouts	1	LS	8,000.00	8,000	
	Miscellaneous flashing, caulking and sealants	1	LS	5,000.00	5,000	
	Skylights - not required				NIC	
EXTERIOR WALLS AND ROOFING					453,100	

REF	DESCRIPTION	QUANTITY	UoM	UNIT RATE	TOTAL	COMMENTS
INTERIOR CONSTRUCTION						
<u>Interior Partitions</u>						
	Metal stud partitions including sound insulation, gypsum board and paint finish	3,200	SF	15.00	48,000	
	Interior doors -allow	22	EA	2,000.00	44,000	
<u>Interior Finishes</u>						
Flooring including base						
	Carpet and vinyl	5,108	SF	8.00	40,864	
	Ceramic tile	400	SF	22.00	8,800	
Walls						
	Ceramic tile	1,200	SF	20.00	24,000	
	Miscellaneous wall finishes - allow	1	LS	15,000.00	15,000	
Ceilings						
	Suspended acoustical tile and gypsum board ceilings	5,508	SF	10.00	55,080	
<u>Equipment</u>						
Kitchen						
	Base cabinet including countertop	30	LF	450.00	13,500	
	Upper wall cabinet	20	LF	200.00	4,000	
	Island	1	EA	3,000.00	3,000	
	Appliances	1	LS	20,000.00	20,000	
Restrooms						
	Vanities	10	LF	300.00	3,000	
	Shower stalls	3	EA	1,500.00	4,500	
	Partitions and accessories	1	LS	6,000.00	6,000	
Offices, meeting room and training room						
	Built-in casework - allow	1	LS	10,000.00	10,000	
	Equipment and accessories	1	LS	10,000.00	10,000	
	Wardrobe lockers - allow	13	EA	1,200.00	15,600	
	Restroom lockers - allow	16	EA	600.00	9,600	
	Laundry room casework, washer and dryer	1	LS	6,000.00	6,000	
	Window blinds or shades	1,125	SF	7.00	7,875	
	Shelving, wall guards and corner guards	1	LS	5,000.00	5,000	
	Signage and graphics (interior and exterior)	1	LS	5,000.00	5,000	
	Miscellaneous equipment and accessories	1	LS	10,000.00	10,000	
	Furniture, beds and moveable furnishings - FF&E Budget				FF&E Budget	
<u>Vertical Transportation</u>						
	Elevator- two stop hydraulic including shaft walls and associated mechanical and electrical requirements	1	EA	100,000.00	100,000	
	Stair including railings	2	EA	15,000.00	30,000	
INTERIOR CONSTRUCTION					498,819	
MECHANICAL, ELECTRICAL, PLUMBING, FIRE PROTECTION						
<u>Plumbing</u>						
	Plumbing system	5,508	SF	23.00	126,684	
<u>Heating and Ventilation</u>						
	Heating and ventilation system (no air conditioning)	5,508	SF	20.00	110,160	
<u>Electrical</u>						
	Electrical system including power, lighting, alarm systems and communications	5,508	SF	32.00	176,256	
<u>Fire Protection</u>						
	Fire sprinkler system	5,508	SF	6.00	33,048	
MECHANICAL, ELECTRICAL, PLUMBING, FIRE PROTECTION					446,148	

Two-Story Living Quarters Building (5,508 SF)

REF	DESCRIPTION	QUANTITY	UoM	UNIT RATE	TOTAL	COMMENTS
SELECTIVE BUILDING DEMOLITION / TEMPORARY WORK						
	Clear site for building pad	5,000	SF	2.00	10,000	
SELECTIVE BUILDING DEMOLITION / TEMPORARY WORK					10,000	
SITE WORK						
	See Site Work Estimate					Site Work
SITE WORK						
DIRECT COSTS SUB-TOTAL					1,759,001	

Existing Apparatus Building (2,400 SF)

REF	DESCRIPTION	QUANTITY	UoM	UNIT RATE	TOTAL	COMMENTS
STRUCTURE						
<u>Existing Foundations</u>						
	Foundation work at new moment frames - allow	110	LF	150.00	16,500	
<u>Existing Bent Frame Structure</u>						
	Allowance for miscellaneous structural modifications to bring existing structure up to current codes - allow	2,400	SF	5.00	12,000	
	Moment frames at overhead doors	3	EA	12,000.00	36,000	
	Moment frames at exterior walls	2	EA	12,000.00	24,000	
<u>Floor and Roof Structure</u>						
	Patch and repair existing concrete slab on grade	2,400	SF	4.00	9,600	
	Steel joist roof structure including plywood decking	2,600	SF	13.00	33,800	
	Wall curbs, equipment pads and curbs	1	LS	5,000.00	5,000	
	Miscellaneous metals and rough carpentry	2,400	SF	5.00	12,000	
STRUCTURE					148,900	
EXTERIOR WALLS AND ROOFING						
<u>Exterior Walls</u>						
	steel stud wall framed exterior walls including plywood sheathing	2,400	SF	16.00	38,400	
	Metal/wood siding, batt insulation, gypsum board and paint to interior face of exterior wall	2,400	SF	25.00	60,000	
	Operable windows - allow	200	SF	80.00	16,000	
	Soffits/roof overhangs	200	SF	25.00	5,000	
	Louvers and vents	1	LS	3,000.00	3,000	
	Entrance doors and service doors	1	LS	10,000.00	10,000	
	Overhead doors - motorized	3	EA	12,000.00	36,000	
	Fascia's, trim and ornamentation	1	LS	5,000.00	5,000	
	Entrance canopy or covered porch	1	LS	5,000.00	5,000	
<u>Roofing</u>						
	Metal roofing including insulation and flashing	2,600	SF	25.00	65,000	
	Gutters and downspouts	1	LS	6,000.00	6,000	
	Miscellaneous flashing, caulking and sealants	1	LS	5,000.00	5,000	
	Skylights - not required				NIC	
EXTERIOR WALLS AND ROOFING					254,400	
INTERIOR CONSTRUCTION						
<u>Interior Partitions</u>						
	Interior partition and door allowance	1	LS	10,000.00	10,000	
<u>Interior Finishes</u>						
<u>Flooring</u>						
	Gym flooring	600	SF	15.00	9,000	
	Concrete sealer	1,800	SF	2.00	3,600	
	Steel structure - paint	2,400	SF	2.00	4,800	
<u>Walls</u>						
	Painted plywood panels	1,500	SF	8.00	12,000	
	Ceiling - paint exposed structure and services	2,400	SF	2.00	4,800	

Existing Apparatus Building (2,400 SF)

REF	DESCRIPTION	QUANTITY	UoM	UNIT RATE	TOTAL	COMMENTS
<u>Equipment</u>						
	Special equipment - allow	1	LS	10,000.00	10,000	
	Bollards at overhead doors	6	EA	1,000.00	6,000	
	Turn-out lockers - allow	24	EA	800.00	19,200	
	Casework and workbench at apparatus room	1	LS	10,000.00	10,000	
	Window blinds or shades	200	SF	7.00	1,400	
	Signage and graphics (interior and exterior)	1	LS	5,000.00	5,000	
	Miscellaneous equipment and accessories	1	LS	10,000.00	10,000	
	Furniture and moveable furnishings - FF&E Budget				FF&E Budget	
INTERIOR CONSTRUCTION					105,800	
MECHANICAL, ELECTRICAL, PLUMBING, FIRE PROTECTION						
<u>Plumbing</u>						
	Plumbing system	2,400	SF	3.50	8,400	
<u>Heating and Ventilation</u>						
	Heating and ventilation system (no air conditioning)	2,400	SF	8.00	19,200	
	Vehicle exhaust system (3 bays)	1	LS	120,000.00	120,000	
<u>Electrical</u>						
	Electrical system including power, lighting, alarm systems and communications	2,400	SF	50.00	120,000	
<u>Fire Protection</u>						
	Fire sprinkler system	2,400	SF	4.00	9,600	
MECHANICAL, ELECTRICAL, PLUMBING, FIRE PROTECTION					277,200	
SELECTIVE BUILDING DEMOLITION / TEMPORARY WORK						
<u>Selective Building Demolition</u>						
	Remove interior construction, exterior walls, mezzanine, roofing, mechanical and electrical systems	2,400	SF	12.00	28,800	
	Hazardous material abatement or removal - excluded				NIC	
<u>Temporary Construction</u>						
	Temporary enclosure/shelter to house vehicles, lockers and equipment during renovation of the apparatus building - allow	8	MO	5,000.00	40,000	
	Shoring and bracing of existing structure during construction	2,400	SF	5.00	12,000	
SELECTIVE BUILDING DEMOLITION / TEMPORARY WORK					80,800	
SITE WORK						
	See Site Work Estimate				Site Work	
SITE WORK						
DIRECT COSTS SUB-TOTAL					867,100	

Apparatus Building Addition (1,100 SF)

REF	DESCRIPTION	QUANTITY	UoM	UNIT RATE	TOTAL	COMMENTS
STRUCTURE						
<u>Building Pad</u>						
	Built-up building pad - allow	1,500	SF	3.00	4,500	
<u>Foundations</u>						
	Perimeter wall footing	120	LF	100.00	12,000	
<u>Vertical Structure</u>						
	Steel stud framed exterior walls with plywood sheathing (load bearing and shearwalls)	1,000	SF	16.00	16,000	
<u>Floor and Roof Structure</u>						
	Slab on grade including base and dowels to existing slab	1,100	SF	12.00	13,200	
	Steel joist roof structure including plywood decking	1,200	SF	15.00	18,000	
	Steel ledger at existing building for roof framing	80	LF	75.00	6,000	
	Wall curbs, equipment pads and curbs	1	LS	3,000.00	3,000	
	Miscellaneous metals and rough carpentry	1,100	SF	3.00	3,300	
STRUCTURE					76,000	
EXTERIOR WALLS AND ROOFING						
<u>Exterior Walls</u>						
	Metal/wood siding, batt insulation, gypsum board and paint to interior face of exterior wall	1,000	SF	25.00	25,000	
	Operable windows - allow	100	SF	80.00	8,000	
	Soffits/roof overhangs	100	SF	25.00	2,500	
	Entrance doors and service doors	1	LS	5,000.00	5,000	
<u>Roofing</u>						
	Metal roofing including insulation and flashing	1,200	SF	25.00	30,000	
	Gutters and downspouts	1	LS	3,000.00	3,000	
	Miscellaneous flashing, caulking and sealants	1	LS	2,000.00	2,000	
	Expansion joint covers (walls and roof)	1	LS	5,000.00	5,000	
	Skylights - not required				NIC	
EXTERIOR WALLS AND ROOFING					80,500	
INTERIOR CONSTRUCTION						
<u>Interior Partitions</u>						
	Interior partition and door allowance	1	LS	5,000.00	5,000	
<u>Interior Finishes</u>						
<u>Flooring including base</u>						
	Concrete sealer	1,100	SF	3.00	3,300	
<u>Ceilings</u>						
	Gypsum board and paint to underside of roof framing	1,100	SF	12.00	13,200	
<u>Equipment</u>						
	Restroom accessories	1	LS	1,000.00	1,000	
	Window blinds or shades	100	SF	7.00	700	
	Miscellaneous equipment and accessories	1	LS	5,000.00	5,000	
	Furniture and moveable furnishings - FF&E Budget				FF&E Budget	
INTERIOR CONSTRUCTION					28,200	

Apparatus Building Addition (1,100 SF)

REF	DESCRIPTION	QUANTITY	UoM	UNIT RATE	TOTAL	COMMENTS
MECHANICAL, ELECTRICAL, PLUMBING, FIRE PROTECTION						
<u>Plumbing</u>						
	Plumbing system	1,100	SF	9.00	9,900	
<u>Heating and Ventilation</u>						
	Heating and ventilation system (no air conditioning)	1,100	SF	15.00	16,500	
<u>Electrical</u>						
	Electrical system including power, lighting, alarm systems and communications	1,100	SF	35.00	38,500	
<u>Fire Protection</u>						
	Fire sprinkler system	1,100	SF	5.00	5,500	
MECHANICAL, ELECTRICAL, PLUMBING, FIRE PROTECTION					70,400	
SELECTIVE BUILDING DEMOLITION / TEMPORARY WORK						
	Clear site for building pad	1,500	SF	3.00	4,500	
SELECTIVE BUILDING DEMOLITION / TEMPORARY WORK					4,500	
SITE WORK						
	See Site Work Estimate					Site Work
SITE WORK						
DIRECT COSTS SUB-TOTAL					259,600	

REF	DESCRIPTION	QUANTITY	UoM	UNIT RATE	TOTAL	COMMENTS
SITE PREPARATION						
<u>Building Demolition</u>						
	No work required					NIC
<u>Site Demolition</u>						
	Miscellaneous site demolition - allow	1	LS	5,000.00	5,000	
<u>Site Clearing and Grading</u>						
	General clearing, grading and compaction	40,000	SF	1.00	40,000	
	Building pad - see building estimate					Building
	Erosion control and site drainage during construction	1	LS	20,000.00	20,000	
SITE PREPARATION					65,000	
SITE DEVELOPMENT						
<u>Vehicular Paving</u>						
	Concrete driveway including curbs and gutters	1,760	SF	15.00	26,400	
	Asphalt paving including curbs and gutters	13,880	SF	10.00	138,800	
	Striping, signage and graphics	1	LS	5,000.00	5,000	
<u>Pedestrian Paving</u>						
	Concrete paving and walkways	2,680	SF	10.00	26,800	
	Patio - see building estimate					Building
<u>Site Structures and Features</u>						
	Trash enclosure	1	LS	10,000.00	10,000	
	Fuel storage system including containment - allow	1	LS	35,000.00	35,000	
	Monument sign, site signage and flagpoles	1	LS	15,000.00	15,000	
	Benches, planters, screen walls and bollards	1	LS	25,000.00	25,000	
<u>Perimeter fencing and gates</u>						
	Wood fencing - allow	600	LF	35.00	21,000	
	Vehicle gate - motorized	1	EA	20,000.00	20,000	
<u>Site Lighting and Power</u>						
	Generator enclosure - allow	1	LS	25,000.00	25,000	
	Emergency generator - see electrical utilities					Electrical Utilities
<u>Site lighting and miscellaneous power</u>						
	Paved areas	18,320	SF	1.50	27,480	
	Landscape areas	16,240	SF	0.50	8,120	
<u>Site Drainage</u>						
<u>Site drainage</u>						
	Paved areas	18,320	SF	1.00	18,320	
	Landscape areas	16,240	SF	0.50	8,120	
	Vehicle wash area containment and filters - allow	1	LS	15,000.00	15,000	
<u>Landscaping and Irrigation</u>						
	Soil preparation, planting and irrigation system	16,240	SF	5.00	81,200	
	Trees - allow	1	LS	10,000.00	10,000	
SITE DEVELOPMENT					516,240	

New Site

REF	DESCRIPTION	QUANTITY	UoM	UNIT RATE	TOTAL	COMMENTS
UTILITIES ON SITE						
<u>Mechanical Utilities (allow 100 LF)</u>						
Water						
	Water service to building	1	LS	10,000.00	10,000	
Fire water						
	Water service to building including riser assembly	1	LS	20,000.00	20,000	
Sanitary sewer						
	Septic system including distribution piping to building	1	LS	50,000.00	50,000	
Storm drainage						
	Included with site drainage					Site Drainage
Natural gas						
	Propane tanks - by Propane Company					Propane Company
	Piping to building	1	LS	5,000.00	5,000	
<u>Electrical Utilities (allow 100 LF)</u>						
Power and communications						
	Incoming service to building	1	LS	20,000.00	20,000	
	Emergency generator, switchboard, automatic transfer switch and day tank (allow 150 KVA)	1	LS	150,000.00	150,000	
	Radio system - by Owner					Owner
UTILITIES ON SITE					255,000	
DIRECT COSTS SUB-TOTAL					836,240	

Existing Site

REF	DESCRIPTION	QUANTITY	UoM	UNIT RATE	TOTAL	COMMENTS
SITE PREPARATION						
<u>Building Demolition</u>						
	Living quarters building	2,175	SF	7.00	15,225	
	Apparatus building addition and slab	200	SF	20.00	4,000	
	Emergency generator building and generator	1	LS	10,000.00	10,000	
<u>Site Demolition</u>						
	Fuel storage system	1	LS	10,000.00	10,000	
	Septic system	1	LS	5,000.00	5,000	
	Miscellaneous site demolition	1	LS	5,000.00	5,000	
<u>Site Clearing and Grading</u>						
	General clearing, grading and compaction	22,000	SF	1.00	22,000	
	Building pad - see building estimate				Building	
	Erosion control and site drainage during construction	1	LS	15,000.00	15,000	
SITE PREPARATION					86,225	
SITE DEVELOPMENT						
<u>Vehicular Paving</u>						
	Concrete driveways including curbs and gutters	1,100	SF	15.00	16,500	
	Asphalt paving including curbs and gutters	6,800	SF	10.00	68,000	
	Patch and repair existing asphalt paving - allow	13,000	SF	1.00	13,000	
	Striping, signage and graphics	1	LS	5,000.00	5,000	
<u>Pedestrian Paving</u>						
	Concrete paving and walkways	1,800	SF	10.00	18,000	
	Patio - see building estimate				Building	
<u>Site Structures and Features</u>						
	Retaining walls at hillside behind new living quarters and apparatus building additions - allow	100	LF	200.00	20,000	
	Trash enclosure	1	LS	10,000.00	10,000	
	Fuel storage system including containment - allow	1	LS	35,000.00	35,000	
	Monument sign, site signage and flagpoles	1	LS	15,000.00	15,000	
	Benches, planters, screen walls and bollards	1	LS	15,000.00	15,000	
	Perimeter fencing and gates					
	Wood fencing - allow	850	LF	35.00	29,750	
	Vehicle gates - motorized	2	EA	20,000.00	40,000	
<u>Site Lighting and Power</u>						
	Generator enclosure - allow	1	LS	25,000.00	25,000	
	Emergency generator - see electrical utilities				Electrical Utilities	
	Site lighting and miscellaneous power					
	Paved areas - new and existing	22,700	SF	1.50	34,050	
	Landscape areas - new and existing	11,900	SF	0.50	5,950	
<u>Site Drainage</u>						
	Site drainage					
	Paved areas - new and existing	22,700	SF	1.00	22,700	
	Landscape areas - new and existing	11,900	SF	0.50	5,950	
	Culvert at new driveway	1	LS	10,000.00	10,000	
	Vehicle wash area containment and filters - allow	1	LS	15,000.00	15,000	
<u>Landscaping and Irrigation</u>						
	Soil preparation, planting and irrigation system	9,200	SF	5.00	46,000	
	Patch and repair existing planting areas	1	LS	5,000.00	5,000	
	Trees - allow	1	LS	5,000.00	5,000	
SITE DEVELOPMENT					459,900	

Existing Site

REF	DESCRIPTION	QUANTITY	UoM	UNIT RATE	TOTAL	COMMENTS
UTILITIES ON SITE						
<u>Mechanical Utilities</u>						
Water						
	Water service to site - existing					Existing
	Distribution to buildings (allow 300 LF)	1	LS	10,000.00	10,000	
Fire Protection						
	Water service to site - existing					Existing
	Distribution to buildings (allow 250 LF plus riser assemblies)	1	LS	25,000.00	25,000	
Sanitary sewer						
	Septic system including 300 LF of distribution piping to buildings	1	LS	60,000.00	60,000	
Storm drainage						
	Included with site drainage					Site Drainage
Natural gas						
	Propane tanks - existing to remain					Existing
	Relocate propane tanks - by Propane Company					Propane Company
	Distribution to buildings (allow 200 LF)	1	LS	8,000.00	8,000	
<u>Electrical Utilities</u>						
Power and communications						
	Incoming service - existing					Existing
	Distribution to buildings	1	LS	15,000.00	15,000	
	Emergency generator, switchboard, automatic transfer switch and day tank (allow 150 KVA)	1	LS	150,000.00	150,000	
	Emergency power distribution to buildings	1	LS	15,000.00	15,000	
	Radio system - by Owner					Owner
UTILITIES ON SITE					283,000	
DIRECT COSTS SUB-TOTAL					829,125	

8.2 Structural report

I. Structural Assessment of Existing Site

Introduction

This report presents the findings of building structural assessments per *ASCE 41: Seismic Rehabilitation of Existing Buildings*. Aspects of building performance that are considered include structural, nonstructural, and foundation/geologic hazard issues. Lifelines such as water, electrical, gas and waste, etc., beyond the perimeter of the building are not considered.

The ASCE 41 process has 3 tiers or levels of evaluation. A Tier 1 evaluation is considered a preliminary phase with the purpose of screening out buildings that are compliant and quickly identifying buildings with potential seismic deficiencies. A Tier 2 evaluation is an analysis of the building that addresses the potential seismic deficiencies identified in Tier 1 screening. A Tier 3 evaluation is a detailed and complete analysis of the building. For this evaluation, a Tier 1 screening was performed.

The structural elements including foundations and the nonstructural elements are evaluated with a choice of three main performance objectives: Collapse Prevention, Life-safety or Immediate Occupancy. In evaluating the fire station site, the life-safety and immediate occupancy damage states were considered. However because the fire station is an emergency facility the ultimate performance objective should be immediate occupancy.

Life-safe structural performance is the post-earthquake damage state in which significant damage to the structure has occurred, but some margin against the onset of partial or total collapse remains. Some structural elements and components are severely damaged, but this does not result in large falling debris hazards, either within or outside the building. Injuries may occur during the earthquake; however overall risk of life-threatening injury as a result of structural damage is expected to be low. It should be possible to repair the structure; however, for economic reasons this may not be practical. While the damaged structure is not an imminent collapse risk, it would be prudent to implement structural repairs or install temporary bracing prior to re-occupancy. Immediate Occupancy structural performance is the post-earthquake damage state to both structural and non-structural components such that damage is not life-threatening so as to permit immediate occupancy of the building after a design earthquake. Damage is repairable while the building is occupied.

The scope of work for the structural building assessments included the following tasks:

1. Reviewing available original construction documents.
2. Making a site visit to confirm that the available drawings properly identify the extent of the building, to observe whether significant building modifications have occurred, and to observe the nonstructural systems bracing and anchorage.
3. Performing the required calculations as required by ASCE 31.
4. Preparing a report summarizing our findings.

Barracks Building

The Barracks building is a single-story, light wood framed structure. The structural system matches that of a single family dwelling. The foundation consists of raised wood floor construction with a continuous concrete perimeter footing and isolated interior concrete piers. The floor and roof framing consist of short spanning, wood members not spaced more than 24 inches apart. The exterior walls and roof have plywood sheathing, while interior walls are sheathed with plaster or gypsum board. Multiple undocumented additions and modifications were observed. In general the additions and modifications consisted of wood construction similar to original construction type.

ASCE 41-13 Seismic Rehabilitation of Existing Buildings describes this structure as Building Type W1. In general this type of structure is ductile and tends to perform well in seismic events.

An ASCE 41-13 Life Safety basic checklist evaluation identifies the structure as being predominately compliant. The main exceptions were unknown factors of liquefaction and surface fault rupture which need to be review by a Geotechnical engineer. In addition the structural load path needs to be confirmed since the original documents do not clearly state how various concealed connections are constructed.

The Barracks building is part of an emergency response facility. Therefore an Immediate Occupancy performance level is required. An ASCE 41-13 Immediate Occupancy checklist evaluation for W1 structures identified a number of noncompliant items. These items must be addressed during a retrofit to comply with CBC requirements for Emergency Faculties. Some of these issues are no Hold-down anchors at shear walls, discontinuous chords and collectors, excessive unblocked diaphragms ratios if only exterior walls are considered part of the lateral resisting elements, interior shear walls with no footings or plywood sheathing if interior walls are considered part of the lateral system, as well as the items identified in the Life Safety check list. These identified issues are all minor in nature and could be retrofitted without significant cost.

The major compliance issue with achieving an Immediate Occupancy building performance level is the structure being located in an area subject to flooding. The structure has been subject to flood waters three times in recent years. In one of those events the structure experienced flood water levels three feet above the finished floor line of the building. Flooding will damage the structure and will render the building inoperable during the period of the flood, which would make an Immediate Occupancy performance level difficult to achieve even after a structural retrofit.

Apparatus Building

The original, main portion of the Apparatus building is a single-story, pre-engineered and pre-fabricated steel building. The structure consists of rigid steel frames in the transverse direction and rod bracing in the longitudinal direction on one side of the structure. There is no lateral system in the longitudinal direction where the large equipment doors are located. The foundation is a concrete slab-on-grade system with spread footings around the perimeter and under the steel frame locations. The walls are constructed with wood studs attached to steel frames and horizontal girts. The roof framing consists of steel joists with lightweight metal roofing. The diaphragm consists of rod bracing in alignment with the vertical rod bracing lateral system locations. An addition and modifications were observed during the site visit. In general the addition and modifications consist of wood construction and are not similar to the pre-manufactured steel building they are connected too.

ASCE 41-13 describes this steel building portion of the structure as Building Type S3. In general this type of system is designed for maximum efficiency of material and cost and not for a high performance during seismic events.

An ASCE 41-13 Life Safety basic checklist evaluation identifies the structure as being predominately noncompliant or unknown. Some of these identified issues are a mezzanine structure not being independently braced from the main building, load path issues related to the various additions, and no confirmation that the original, economically designed steel system has the additional capacity to resist the added demands from the various additions. The unknown factors of liquefaction and surface fault rupture also exist and need to be review by a Geotechnical engineer.

The Apparatus building is part of an emergency response facility. Therefore an Immediate Occupancy performance level is required. An ASCE 41-13 Immediate Occupancy checklist evaluation for S3 structures identified a number of noncompliant items which would need to be addressed during a retrofit to comply with CBC requirements for Emergency Facilities. Most of these noncompliant issues relate to the steel frame ductility checks. Since this type of steel system is typically designed for economy and not performance it would be anticipated that the identified issues would be major in nature and could be a challenge to retrofit without significant cost. The items identified in the Life Safety check list would also need to be addressed by the retrofit.

Two additional compliance issues required to achieve an Immediate Occupancy building performance level are the structure being located in an area subject to flooding and being located adjacent to a slope. In recent years the property has flooded numerous times. Although this structure has not been flooded, access into and out of the emergency facility during a flood event was impeded and would need to be evaluated and addressed. Due to the building being located within close proximity to an adjacent slope a Geotechnical engineer must evaluate the risk of slope failure and rock falls.

II. Option A: New Fire Station, Idealized Site

The structural system narrative is based on the concept architectural plans for a new apparatus building adjacent to an office and living quarters building as shown below. The two structures will be separate by a seismic joint.

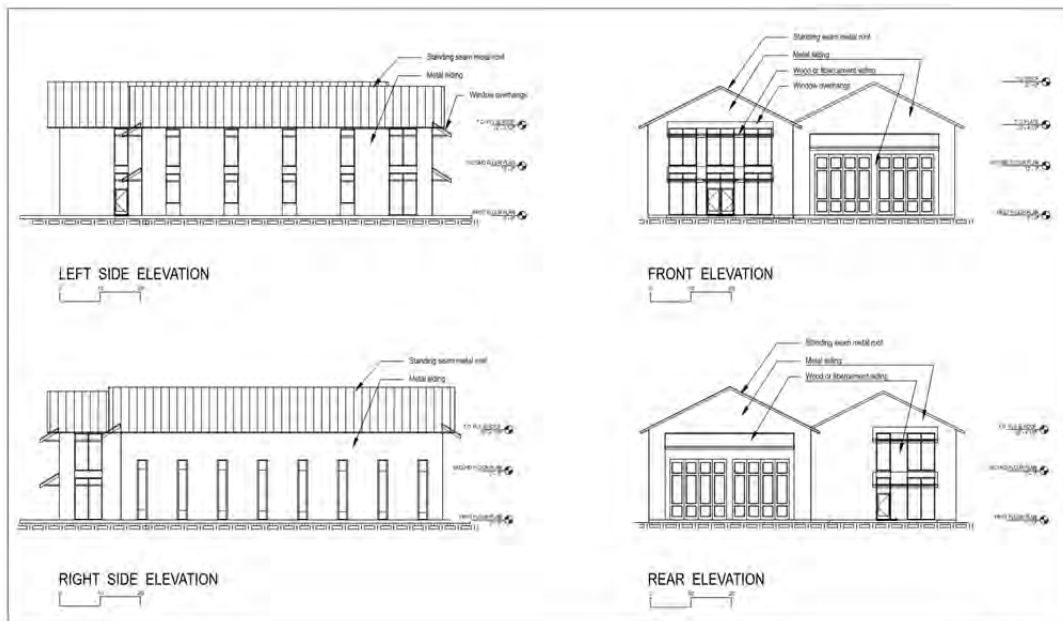
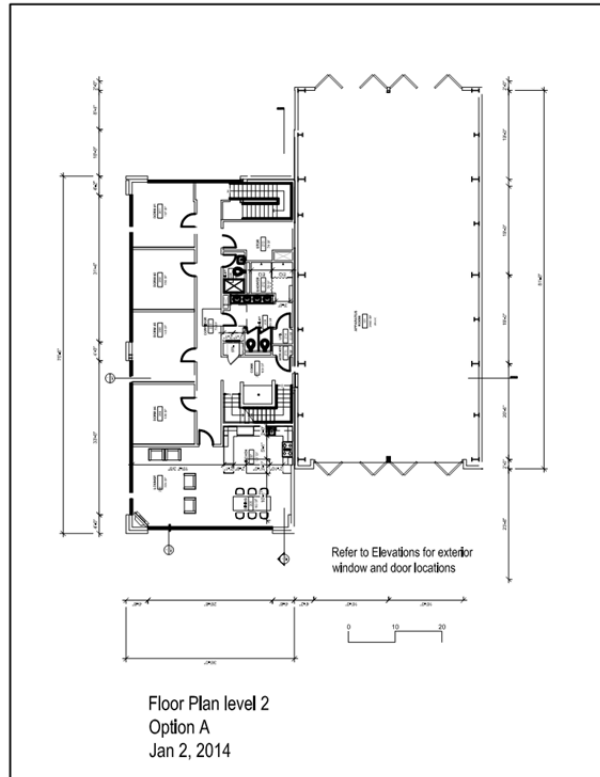
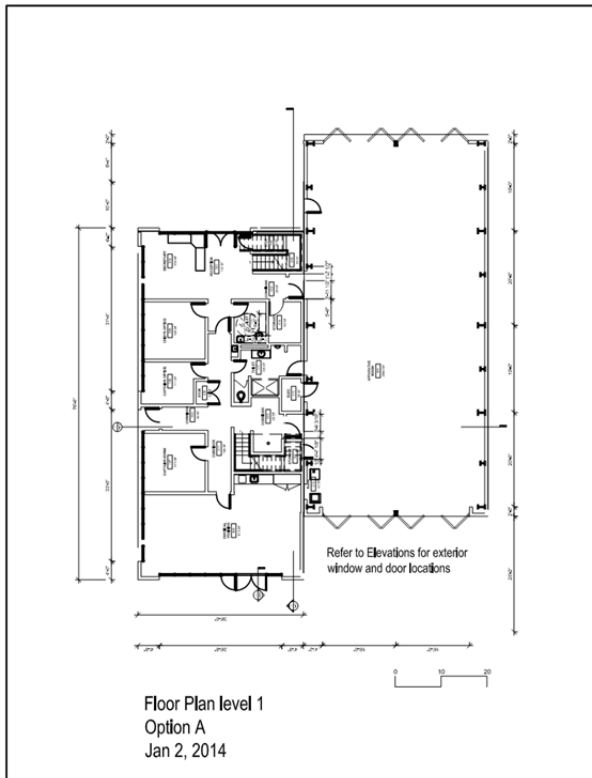

The structural gravity system for the apparatus structure consists of steel beams in the transverse direction and along the perimeter supported on steel columns. Light gauge or wood roof framing members span between the steel beams to form the roof system. Exterior cladding is composed of either light gauge steel studs or wood studs spanning from the foundation to the roof framing level. The lateral system consists of steel moment frames in the transverse direction and plywood shear walls in the longitudinal direction. Reinforced masonry shear walls is an option to the plywood walls in the longitudinal direction. A plywood roof diaphragm is used to transfer seismic forces to the lateral system.

The structural gravity system for the Office/Living Quarters structure consists of light gauge or wood joists at the roof and floor levels. The joists at both levels are supported by light gauge or wood stud interior and exterior bearing walls. Roof joists span the transverse direction and are supported on interior corridor walls as required. The direction of floor joists framing is dependent on the Level One wall layout. As an alternate to roof and floor joists, trusses can be utilized at both levels. The lateral system in both transverse and longitudinal directions consists of plywood shear walls. Plywood roof and floor diaphragms are used to transfer seismic forces to the lateral system. For both gravity and lateral systems to be implemented efficiently, a series of interior walls in both the longitudinal and transverse direction must be "stacked" between the first and second levels to provide continuous load paths to the foundation. In addition at the front and rear exterior walls one or more of the wall segments must have a height to width ratio no greater than 2:1 between each framing level for plywood shear walls to be utilized.

The ideal site for these types of structures is a relatively flat site with soils suitable for typical continuous shallow reinforced concrete footings with a concrete slab-on-grade. Sites with expansive or liquefiable soils should be avoided if possible. Sites subject to flooding should be avoided.

III. Option B: New Living Quarters/Offices Building and Renovate Apparatus Building at Pescadero Creek Road Site

The structural system narrative is based on the concept architectural plans shown on this page. The new Living Quarters/Office portion of the structure is assumed to be the same layout as Option A.

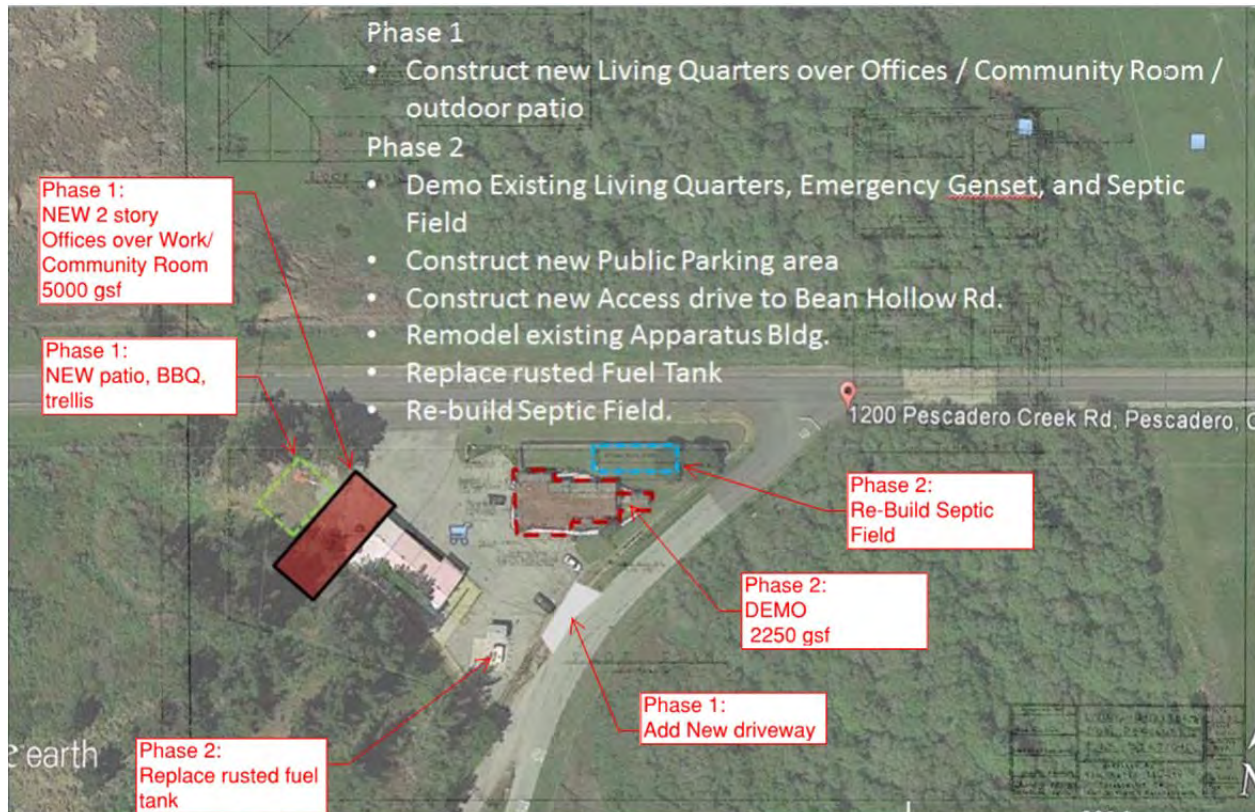

The station would consist of two separate building structures: new Office/Living Quarters and renovated Apparatus.

The structural gravity system for the Office/Living Quarters structure consists of light gauge or wood joists at the roof and floor levels. The joists at both levels are supported by light gauge or wood stud interior and exterior bearing walls. Roof joists span the transverse direction and are supported on interior corridor walls as required. The direction of floor joists framing is dependent on the Level One wall layout. As an alternate to roof and floor joists, trusses can be utilized at both levels. The lateral system in both transverse and longitudinal directions consists of plywood shear walls. Plywood roof and floor diaphragms are used to transfer seismic forces to the lateral system. For both gravity and lateral systems to be implemented efficiently, a series of interior walls in both the longitudinal and transverse direction must be “stacked” between the first and second levels to provide continuous load paths to the foundation. In addition at the front and rear exterior walls one or more of the wall segments must have a height to width ratio no greater than 2:1 between each framing level for plywood shear walls to be utilized.

With minor modifications the existing apparatus building should have a gravity system capability of meeting the requirements for Immediate Occupancy as described previously. However, the existing

Pescadero Fire Station
Structural Recommendations

structure lacks a lateral system adequate to meet the requirements of Immediate Occupancy for Emergency Response building occupancies. As described in the existing apparatus building evaluation the structure is a single-story, pre-engineered and pre-fabricated steel building. In general this type of system is designed for maximum efficiency of material and cost and not for a high performance during seismic events. Therefore, the existing lateral system will be abandoned in place and allowing the steel frames to remain as the primary gravity system only. A new lateral system will supersede the existing system. The new system will consist of plywood shear walls on as many as four sides of the structure over new light gauge or wood stud exterior walls. Depending on the height to width ratios of the new shear walls, the existing foundation may be determined to be adequate if the ends of the walls terminate at steel column locations. At the front and left side of the structure new steel moment frames may need to be installed to resist lateral forces if the existing window and door openings cannot be modified to allow for plywood shear walls to be utilized. New foundation elements will be required at steel moment frame locations. Plywood roof diaphragm will be used to transfer seismic forces to the new lateral system.

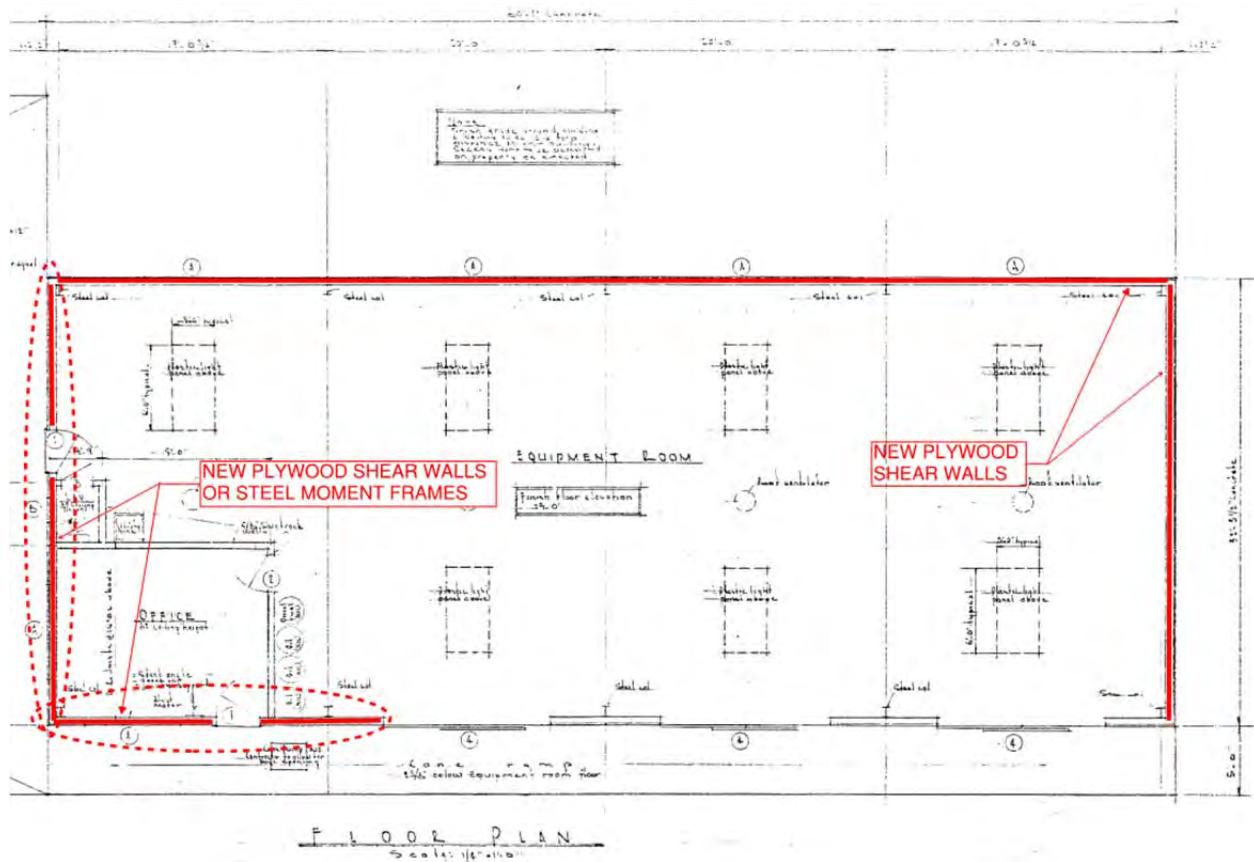

8.3 Mechanical, electrical, and plumbing report

NBA ENGINEERING, INC.

San Francisco * Oakland * Los Angeles

Fire Station at 1200 Pescadero Creek Rd, **Pescadero, CA** **Investigative Study for Mechanical &** **Electrical Systems**

Bill Blessing
Ratcliff Architects
5856 Doyle Street
Emeryville, CA 94608

NBA ENGINEERING, INC.

I. Existing Conditions:

A. Electrical Systems Existing Conditions

Currently, the fire station consists of four buildings: the Living Quarters, the Apparatus Building, the Pump Room, and the Generator Room. The entire station's power is provided by a pole-mounted, PG&E 15KVA, single-phase transformer. The service to the four buildings is a 120/240V, 1PH, 3-wire system. In addition, there is a 50 KW/62.5 KVA diesel fuel standby generator with an automatic transfer switch to provide power in case of emergency. Most of the electrical equipment, including the standby generator (see EE2), and automatic transfer switch (see EE3), has been in use for more than thirty years. The coastal climate, severe weather conditions, and some flooding have caused rusting of the enclosed outdoor service entrance equipment (see EE1). Some of the equipment covers are missing or broken. The existing storage room panel board is very old and rusted (see EE1). The amperage in the exercise room is not adequate to run the exercise equipment. There is no security camera or intrusion detection system in this facility.

The following lighting installations have been observed in the field:

1. There are smoke detectors missing from the bedrooms.
2. Due to years of operation, the translucent acrylic prismatic fluorescent fixture diffusers have become discolored at the center/edge of the luminaire (see EE5).
3. Most of the fluorescent fixtures are equipped with 40-watt lamps, which are considered obsolete. The current standard for fluorescent lamps with electronic ballast is a rating of 32 watts.
4. Building door lights and fixtures at the Living Quarters are equipped with 60-watt incandescent lamps. One wall mounted light in the Living Quarters is broken (see EE6). Incandescent lamps consume more energy and provide less illumination than compact fluorescent lamps.
5. There are five high-wattage security HID flood lights on the building roof that consume a great deal of electricity when in use.
6. There are three 25-inch diameter HID fixtures, plus eight 2 lamp, 1'x4' industrial-type fluorescent fixtures in the Apparatus Building. All fixtures are ceiling-mounted. There is a time delay due to lamp warm up when the HID lights are turned on. This hampers operation and maintenance of the vehicles.

NBA ENGINEERING, INC.

Miscellaneous Findings:

1. Most of the receptacles inside all three buildings are worn, having been in use for many years. Some are discolored. They need to be replaced.
2. Ceiling-mounted, battery-powered smoke detectors have been found in some rooms. Some rooms lack these smoke detectors, particularly in Living Quarters.
3. Sump pump power and control equipment is located outdoors in a wooden cabinet adjacent to the Headquarters building. The enclosures show rust.

B. Mechanical Systems Existing Conditions

There is no gas or sewer piping to these buildings. There is an underground septic tank for black water. The septic tank floods periodically, requiring station personnel to rent and use portable toilet facilities when the septic system is being repaired and cleaned.

A propane tank provides gas to these buildings. The kitchen oven runs on propane. There is an old propane domestic water heater serving showers and lavatories in the Living Quarters (see ME1). There is rust on the 500 gallon propane tank and the dual fuel tank (1000 gallon diesel and 500 gallon unleaded gasoline), probably due to flooding. The fuel tank appears leak (see ME3 and ME5).

An old, forced-air propane furnace serves the Living Quarters, (see ME2). The ductwork lacks insulation. There are no heating ducts to some of the rooms in the Living Quarters. There is no indication of mechanical ventilation in either the Living Quarters or in the Apparatus Building. There are no fire sprinkler and no fire alarm systems. A large proportion of the equipment is rusted, possibly due to salt water.

The available utilities are Pescadero Community Water System, which provides potable water, and Pacific Gas & Electric providing power. A well on the hill above the site has a holding tank that feeds the stand pipe. It provides non-potable water.

There is a 240-volt air compressor for shop air requirements/Apparatus Building, which is aged. There are three overhead exhaust systems with control boxes on the wall in the Apparatus Building. This building has no fire alarm or fire sprinkler. There is an antiquated bathroom and sink and in the Apparatus Building.

Heat for the Apparatus Building is provided by an old, propane-fired, Reynar unit heater, (see ME6), which has some rusted piping and no insulation on the exhaust flue. There is no heat in the Apparatus Building office areas. The engine area of the Apparatus Building is too small and too proximate to the roll up door. Existing HVAC control systems are localized via thermostat.

NBA ENGINEERING, INC.

II. Option A- New, Single-Building, Fire Station Site

A. Electrical System

A new site will require a 120/240 VAC, single phase, 3 wire power distribution system. A new service transformer shall be provided and installed by the utility company (PG&E) to meet new load requirements. The new utility transformer shall be either the pole mounted or the pad mounted type. Building lighting will be served by a 120 or 208 VAC single phase system. Receptacles shall be served with 120 VAC system. A standby diesel generator and automatic transfer switch shall be provided for emergency power outages.

List of desirable electrical items in an ideal site:

1. New utility company service transformer,
2. Service entrance panel board with utility meter socket,
3. Two power distribution panel boards, one located in Level 1 and the other located in Level 2,
4. New standby diesel generator and associated automatic transfer switch,
5. Addressable fire alarm system for the building
6. CCTV/security systems for the building
7. Telephone system for the building
8. LED type security floodlights for the new building and surrounding areas.
9. An energy management system to control HVAC systems.

B. Mechanical Systems

The building shall be provided with HVAC systems consistent with the design conditions in order to maintain occupants' comfort and functional requirements. Heating and ventilating units and exhaust fans for different zones shall be provided to supply heating and ventilation to the apparatus room, electrical room, dorms, lounge, kitchen, dining, corridors, toilets, shower room, and janitor storage. One split-system heat pump unit per zone will be provided to serve the office area that includes areas for secretary, reception, corridor, and storage. A ductless, split heat pump unit shall be provided to serve the physical training area. Make-up air unit and exhaust fans shall be provided for the engine exhaust in the apparatus room.

The HVAC systems will be equipped with local digital thermostats. Kitchen shall be provided with state-of-the-art exhaust hood and a stove, refrigerator, dish washer, dual-sink, and a garbage disposal.

A. Plumbing Systems

The building plumbing fixtures will include low-flow water closets, urinals, and lavatories; showers, sinks, floor drains, trap primers, hose bibs, roof drains, overflow drains, washing machine hook-up or drains, trench drains, area drains, and filtered water system. One high-efficiency, central, gas-fired, water heater shall be provided to supply domestic hot water for the showers, lavatories, and sinks. A circulating pump will be installed to maintain hot water at the point of use. A compressed-air system with a refrigerated dryer shall be provided to supply compressed air to the apparatus room. A double wall fuel storage tank for diesel and unleaded gasoline fuels will be provided. The fuel storage tanks shall be

NBA ENGINEERING, INC.

equipped with leak detection sensors and monitoring units. All utilities, gas, water, sewer, storm, and fire water to be piped from city/county systems.

III. Option B- Keep Existing Site , New Living Quarters over Offices, Modify Apparatus Building

A. Electrical System

Power distribution system shall be a 120/240VAC, single phase, 3 wire system. It is recommended that a new service transformer shall be provided and installed by PG&E to replace the existing one. Building lighting will be served by a 120 or 208VAC single phase system .Receptacles will be served by a 120VAC system. A standby diesel generator and automatic transfer shall be provided to replace the existing ones.

List of electrical items to be demolished

1. Existing pole-mounted utility transformer,
2. Existing service entrance panel board with utility meter,
3. Existing panel board "ILEC",
4. Existing diesel standby generator and associated automatic transfer switch,
5. All fluorescent fixtures inside the existing buildings,
6. All building door/outside wall-mounted incandescent light fixtures,
7. All lighting fixtures inside Apparatus Building,
8. All roof-mounted HID floodlights,
9. All conduit, wires, junction boxes associated with demolition items.

B. Mechanical Systems

The buildings shall be provided with HVAC systems consistent with the design conditions in order to maintain occupants' comfort and functional requirements. Heating and ventilating units and exhaust fans for different zones shall be provided to supply heating and ventilation to the apparatus room , electrical room, dorms, lounge, kitchen, dining, corridors, toilets, shower room, and janitor storage. One split-system heat pump unit per zone will be provided to serve the office area that includes areas for secretary, reception, corridor, and storage. A ductless, split heat pump unit shall be provided to serve the physical training area. Make-up air unit and exhaust fans shall be provided for the engine exhaust in the Apparatus Building.

The HVAC systems will be equipped with local digital thermostats. Kitchen shall be provided with state-of-the-art exhaust hood and a stove, refrigerator, dish washer, dual-sink, and a garbage disposal.

C. Plumbing Systems

The buildings' plumbing fixtures will include low-flow water closets, urinals, and lavatories; showers, sinks, floor drains, trap primers, hose bibs, roof drains, overflow drains, washing machine hook-up or drains, trench drains, area drains, and filtered water system. One high-efficiency, central, gas-fired, water heater shall be provided to supply domestic hot water for the showers, lavatories, and sinks. A circulating pump will be installed to maintain hot water at the point of use. A compressed-air system with a refrigerated dryer shall be provided to supply compressed air to the Apparatus Building. A double wall

NBA ENGINEERING, INC.

fuel storage tank for diesel and unleaded gasoline fuels will be provided. The fuel storage tanks shall be equipped with leak detection sensors and monitoring units.

List of mechanical and plumbing items to be demolished

1. All the HVAC equipment: furnace, toilet exhaust fans, kitchen hood exhaust fan, and distribution systems (ductwork, diffusers, exhaust grills, etc.) and controls (thermostat) for the Living Quarters shall be demolished and discarded;
2. The existing unit heater and associated piping and exhaust flue in the Apparatus Building shall be demolished and discarded;
3. All existing lavatories and water closets and kitchen sink in the Living Quarters and lavatory and water closet area shall be demolished and discarded;
4. Demolish and discard existing dual fuel tank,
5. Remove and discard existing propane tank,
6. Remove and discard existing air compressor.

NBA ENGINEERING, INC.



ME1 – Water heater and furnace

NBA ENGINEERING, INC.



ME2 – Gas furnace

NBA ENGINEERING, INC.



ME3 – Liquid fuel tank

NBA ENGINEERING, INC.



ME4 – Non-potable water connection

NBA ENGINEERING, INC.



ME5 – Propane fuel tank

NBA ENGINEERING, INC.



ME6 – Gas unit heater

NBA ENGINEERING, INC.



EE1 – Fire Station entrance equipment cabinet

NBA ENGINEERING, INC.



EE2 – Single phase diesel fuel standby generator



EE3 – Automatic transfer switch

NBA ENGINEERING, INC.



EE4 – Storage Room panel

NBA ENGINEERING, INC.



EE5 – Living quarters corridor lights

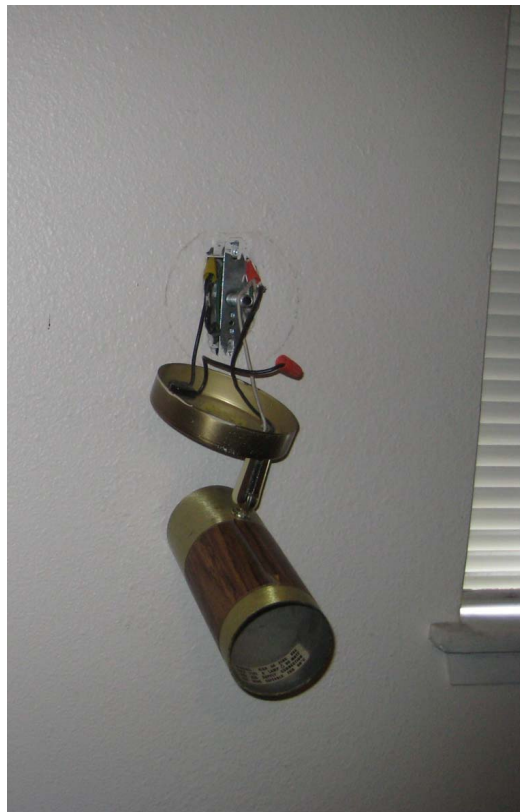

EE6 – Damaged light, Living Quarters

8.4 Civil engineering report

DRAFT
CIVIL ASSESSMENT

FOR

PESCADERO FIRE STATION

Pescadero, California

Prepared For:
Ratcliff
5856 Doyle Street
Emeryville, CA 94608

Prepared By:
CSW/Stuber-Stroeh Engineering Group, Inc.
45 Leveroni Court
Novato, California 94949
(415)-883-9850

Prepared:
January 3, 2014

CSW | ST2 File No.:
4.1174.00

Introduction

The San Mateo County Fire Station located at 1200 Pescadero Creek Road in Pescadero, CA (Pescadero Fire Sta.) consists of four buildings on a 1.3 acre site. According to the contract drawings and as-builts, the station was originally constructed in 1957 with various improvements made since that time. The site is located within the flood plain which creates a number of issues which will be discussed below. The site and buildings are outdated and in need of improvement, either at the existing site, or at a new site, in order to meet current standards and to adequately serve its community.

Existing Conditions

As mentioned above, the Pescadero Fire Sta. is located in the flood plain of the Butano Creek (see "Pescadero Floodway Map" attached). The site has experienced an increase in the occurrence of flooding since the mid 1980's due to the accumulation of silt and debris in Butano Creek and Pescadero Marsh as a result of halted dredging operations. It is reported that the site floods at least once a year with as much as three feet of water reported in 1998. Pescadero Creek Road also floods during these events. As such, the Pescadero Fire Sta. staff relocates to alternative sites during heavy rains so that they can maintain their ability to respond to emergency events.

Civil utilities on-site consist of domestic water served by the local water service municipality. Additionally, there is an on-site well used for non-potable water needs (i.e. to supply the existing wharf hydrant), and a septic system for the disposal of site generated sewage waste. The septic system is reported to back-up during flood events, which is to be expected considering the ground would be saturated during these events and would have no additional hydraulic capacity. The system was constructed along with the rest of the site in 1957. Considering the age of the system, it is unlikely that it meets current code. Additionally, septic systems have an average lifespan of 25 years. As such, it is likely that the system at the Pescadero Fire Sta. has reached the end of its useful life, though it would have to be tested to confirm this.

Option A. New Fire Station / Idealized Site

The selected site should be one that is located at an elevation that is above the flood plain with additional vertical elevation to allow for sea level rise. Additionally, the road(s) leading to and from the fire station should be similarly above flood elevations to maximize, as much as possible, access to the community during flood events. There shall also be adequate space on-site to provide for State and local storm water treatment requirements.

Domestic water shall be provided by the local water service municipality if available at the selected location. If municipal water is unavailable at the selected location, there must be adequate potable well water available to serve the new fire station's needs.

In absence of any municipal sewer system, the sewage disposal needs will need to be met with an on-site septic system that meets current code. As such, there must be adequate space and soil conditions to accommodate this.

Option B. Keep Pescadero Creek Rd Site: New Living Quarters over Offices, Renovate Apparatus Bldg.

In this scenario, the existing residence building will be demolished and relocated to a new two story addition adjacent to the existing apparatus building. The new addition must be constructed such that the finished floor elevation of the first level is above the flood elevation with additional vertical elevation clearance to allow for sea level rise. The existing apparatus building, however, may be at an elevation that is below future flood elevations as sea level rise continues. As such, this building may experience flooding in the future. A new driveway access will be constructed to Bean Hollow Road at the south-east side of the site which is at a higher elevation than the existing access from Pescadero Creek Road. This will improve access during flood events, though access to Pescadero Creek Road will still be limited due to flooding. Space will also have to be dedicated on-site to meet State and local storm water treatment requirements. The location of the existing residence would be a likely alternative for this.

The new addition is likely to be situated such that a portion of the existing hillside will have to be excavated to accommodate the structure. As such, a new retaining wall will need to be constructed along with adequate drainage facilities to capture hillside runoff.

Domestic water will continue to be served by the local water service municipality.

A new septic system will likely be required. The location of the existing system would be the ideal location if it has adequate space and soil conditions to accommodate a system that meets current code. Due to the likelihood of high groundwater at the location of the existing system, a shallow pressure dosing system would likely be required. However, because this location becomes inundated with water during flood events (see Photo 1), it is unlikely that this location will meet code. As such, alternative locations on site should be considered such as the western side of the site or on the hillside along the southern end of the site. It is unlikely, however, that the southern end will be feasible due to the steep slope and the confined area.



Septic field with flood elevation marker (white post with red marks) shown in the background

8.5 Reference documents

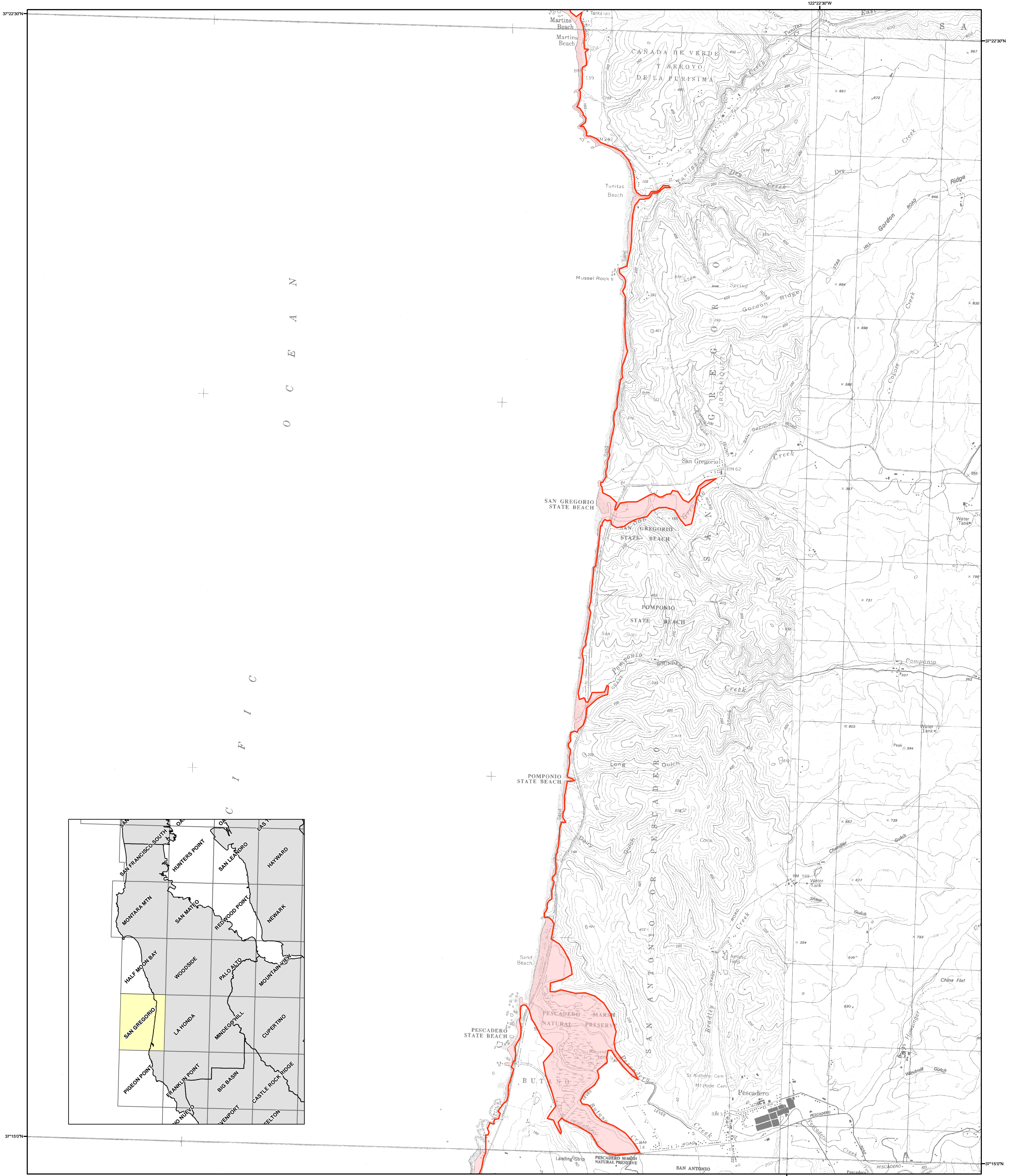

METHOD OF PREPARATION

Initial tsunami modeling was performed by the University of Southern California (USC) Tsunami Research Center funded through the California Emergency Management Agency (CalEMA) by the National Tsunami Hazard Mitigation Program. The tsunami modeling process utilized the MOST (Method of Splitting Tsunamis) computational program (Version 0), which allows for wave evolution over a variable bathymetry and topography used for the inundation mapping (Titov and Gonzalez, 1997; Titov and Synolakis, 1998).

The bathymetric/topographic data that were used in the tsunami models consist of a series of nested grids. Near-shore grids with a 3 arc-second (75- to 90-meters) resolution or higher, were adjusted to "Mean High Water" sea-level conditions, representing a conservative sea level for the intended use of the tsunami modeling and mapping.

A suite of tsunami source events was selected for modeling, representing realistic local and distant earthquakes and hypothetical extreme undersea, near-shore landslides (Table 1). Local tsunami sources that were considered include offshore reverse-thrust faults, restraining bends on strike-slip fault zones and large submarine landslides capable of significant seafloor displacement and tsunami generation. Distant tsunami sources that were considered include great subduction zone events that are known to have occurred historically (1960 Chile and 1964 Alaska earthquakes) and others which can occur around the Pacific Ocean "Ring of Fire."

In order to enhance the result from the 75- to 90-meter inundation grid data, a method was developed utilizing higher-resolution digital topographic data (3- to 10-meters resolution) that better defines the location of the maximum inundation line (U.S. Geological Survey, 1993; Intermap, 2003; NOAA, 2004). The location of the enhanced inundation line was determined by using digital imagery and terrain data on a GIS platform with consideration given to historic inundation information (Lander, et al., 1993). This information was verified, where possible, by field work coordinated with local county personnel.

The accuracy of the inundation line shown on these maps is subject to limitations in the accuracy and completeness of available terrain and tsunami source information, and the current understanding of tsunami generation and propagation phenomena as expressed in the models. Thus, although an attempt has been made to identify a credible upper bound to inundation at any location along the coastline, it remains possible that actual inundation could be greater in a major tsunami event.

This map does not represent inundation from a single scenario event. It was created by combining inundation results for an ensemble of source events affecting a given region (Table 1). For this reason, all of the inundation region in a particular area will not likely be inundated during a single tsunami event.

References:

Intermap Technologies, Inc., 2003, Intermap product handbook and quick start guide: Intermap NEXTmap document on 5-meter resolution data, 112 p.

Lander, J.F., Lockridge, P.A. and Kozuch, M.J., 1993, Tsunamis Affecting the West Coast of the United States 1806-1992: National Geophysical Data Center Key to Geophysical Record Documentation No. 29, NOAA, NESDIS, NGDC, 242 p.

National Atmospheric and Oceanic Administration (NOAA), 2004, Interferometric Synthetic Aperture Radar (IFSAR) Digital Elevation Models from GeoSAR platform (EarthData): 3-meter resolution data.

Titov, V.V., and Gonzalez, F.I., 1997, Implementation and Testing of the Method of Tsunami Splitting (MOST): NOAA Technical Memorandum ERL PML – 112, 11 p.

Titov, V.V., and Synolakis, C.E., 1998, Numerical modeling of tidal wave runup: Journal of Waterways, Port, Coastal and Ocean Engineering, ASCE, 124 (4), pp 157-171.

U.S. Geological Survey, 1993, Digital Elevation Models: National Mapping Program, Technical Instructions, Data Users Guide 5, 49 p.

TSUNAMI INUNDATION MAP FOR EMERGENCY PLANNING

State of California ~ County of San Mateo
SAN GREGORIO QUADRANGLE

June 15, 2009

SCALE 1:24,000

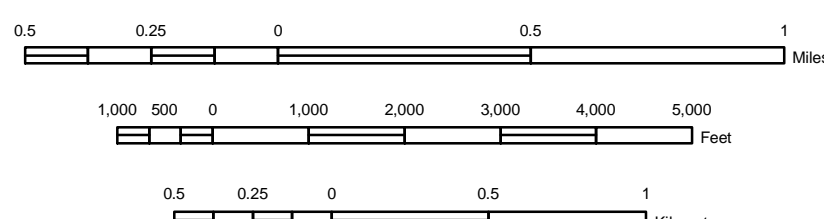

Table 1: Tsunami sources modeled for the San Mateo County coastline.

Sources (M = moment magnitude used in modeled event)	Areas of Inundation Map Coverage and Sources Used	
	San Francisco Bay	Pescadero
Local Sources		
Point Reyes Thrust Fault	X	
Rodgers Creek-Hayward Faults	X	
San Gregorio Fault	X	
Distant Sources		
Cascadia Subduction Zone-full rupture (M9.0)	X	
Central Aleutians Subduction Zone #1 (M8.9)	X	X
Central Aleutians Subduction Zone #2 (M8.9)	X	
Central Aleutians Subduction Zone #3 (M9.2)	X	X
Chile North Subduction Zone (M9.4)	X	
1960 Chile Earthquake (M9.3)	X	
1964 Alaska Earthquake (M9.2)	X	X
Japan Subduction Zone #2 (M8.8)	X	
Kuril Islands Subduction Zone #2 (M8.8)	X	
Kuril Islands Subduction Zone #3 (M8.8)	X	
Kuril Islands Subduction Zone #4 (M8.8)	X	
Marianas Subduction Zone (M8.6)	X	X

MAP EXPLANATION

- Tsunami Inundation Line
- Tsunami Inundation Area

PURPOSE OF THIS MAP

This tsunami inundation map was prepared to assist cities and counties in identifying their tsunami hazard. It is intended for local jurisdictional, coastal evacuation planning uses only. This map, and the information presented herein, is not a legal document and does not meet disclosure requirements for real estate transactions nor for any other regulatory purpose.

The inundation map has been compiled with best currently available scientific information. The inundation line represents the maximum considered tsunami runup from a number of extreme, yet realistic, tsunami sources. Tsunamis are rare events; due to a lack of known occurrences in the historical record, this map includes no information about the probability of any tsunami affecting any area within a specific period of time.

Please refer to the following websites for additional information on the construction and/or intended use of the tsunami inundation map:

State of California Emergency Management Agency, Earthquake and Tsunami Program: <http://www.oes.ca.gov/WebPage/oeswebsite.nsf/Content/B1EC51BA215931768825741F005E8D80?OpenDocument>

University of Southern California – Tsunami Research Center: <http://www.usc.edu/dept/tsunamis/2005/index.php>

State of California Geological Survey Tsunami Information: http://www.conservation.ca.gov/cgs/geologic_hazards/Tsunami/index.htm

National Oceanic and Atmospheric Agency Center for Tsunami Research (MOST model): <http://nctr.pmel.noaa.gov/time/background/models.html>

MAP BASE

Topographic base maps prepared by U.S. Geological Survey as part of the 7.5-minute Quadrangle Map Series (originally 1:24,000 scale). Tsunami inundation line boundaries may reflect updated digital orthophotographic and topographic data that can differ significantly from contours shown on the base map.

DISCLAIMER

The California Emergency Management Agency (CalEMA), the University of Southern California (USC), and the California Geological Survey (CGS) make no representation or warranties regarding the accuracy of this inundation map nor the data from which the map was derived. Neither the State of California nor USC shall be liable under any circumstances for any direct, indirect, special, incidental or consequential damages with respect to any claim by any user or any third party on account of or arising from the use of this map.



Meeting Minutes

Meeting Date: November 20, 2013
Meeting time: 9:30 am

Meeting No.: 2

Project: Pescadero Fire Station (PFS) Assessment Study
Pescadero, CA
Ratcliff Project No: 32053.00

Place: Pescadero Fire Station

Attendees:

Name	
Bill Blessing, Ratcliff	Guido Misculin, San Mateo County
Nina Pakanant, Ratcliff	Theresa Yee, San Mateo County
Scott Ernest, PFS	
Robert Pierson, PFS	
Andy Cope, PFS	

Meeting Minutes:

Item	Agenda topic	Action	Due Date
1	Existing Drawings <ul style="list-style-type: none"> - Ratcliff received existing drawings of the Apparatus Building. - Current fire station service coverage: <ul style="list-style-type: none"> o North boundary – Tunitas Creek Rd. o East boundary – Hwy 84 o South boundary – Cloverdale Rd. - Ratcliff needs a Service Area map. 		
2	Ratcliff Presentation <ul style="list-style-type: none"> - Presented example of stations from Chico Airport Fire Station, Yuba City Fire Station, and Emeryville Fire Station. - Proposed new site in Town of Pescadero is also in the flood zone. - San Mateo OES can provide Tsunami plan. 		
3	Issues with current fire station location <ul style="list-style-type: none"> - During seasonal flood, an engine from Station 17 is sent to a site nearby high school. A temporary modular trailer is set up at the fire station. - Chemical run off contaminates rain water. - Response plan includes Engine 40 from Half Moon Bay and Station 55 (volunteer). 		
4	Staffing <ul style="list-style-type: none"> - Under normal budget, the station has 4 staff (2 rescuers, 2 engine staff). Under the budget cut, the station has 3 engine staff and 1 supplemental rescuer. - Maximum staff is 9. This occurs approximately 8 times per 		

		<ul style="list-style-type: none"> - year. - Fire season is between: May 15 – Nov. 1. When maximum staffing typically occurs. - During off-season: 3-4 staff - Typical shift: 3 work days. 4 off days. 		
5		<p>Site</p> <ul style="list-style-type: none"> - Currently the overall storage space is insufficient. The shed and shipping container houses landscaping tools and emergency supplies. - Current above grade dual fuel tank is rusting and has some leaks. - Original underground tank had been dug out. (soil contamination ?) - Well water is used for the Apparatus and hydrants. The Living Quarters uses potable city water. - Current emergency power generator is pre 1983. - PFS is ok with 72 hr generator. Ratcliff to confirm size needed. - Need a wharf hydrant. - Hose rack is antiquated. Prefer modern hose dryer. 		
6		<p>Apparatus Bay</p> <ul style="list-style-type: none"> - Current engines: (1) Type 1 engine, (1) rescue 59, (1) seasonal Type 3, (1) utility pick-up truck, (1) water tender - Prefer solution for adjacency among decontamination, turn-out room, and extractor equipment spaces. - Currently turnout gear is on sides and rear of Apparatus bays, and is circulation around vehicles is reduced. - Need sizable medical storage due to the variety of incident types required: coastal waters, coastal cliffs, highway, forest, town. - Ratcliff needs make and model of the engines for planning. - Staff performs minor station repairs on site, others by County mechanics. - Need washing apparatus pad. Prefer indoor. Underside spray needed due to salt vapor within coastal areas. - Currently no oil disposal set up. - Need to accommodate 11'-3" high truck at this time. - Rear addition (date:?) includes area for physical training. - Area is insufficient and not efficiently laid out. At present – no daylight and area is mixed with vehicle bay air systems. 		
7		<p>Public/ Office</p> <ul style="list-style-type: none"> - PFS prefers having a lobby/office area to receive visitors. - Office space requirements: (2) workstations, (1) EMS workstation, (1) captain's office - Guido requested Ratcliff to present an option of having Emergency Operation Center function. - Prefers having spaces to accommodate public meetings and training (e.g. PMAC Meeting and voting) - Current EMS training takes place at Station 40. - Outdoor training takes place at PFS. - Deliveries: occasional big deliveries. - Need public restroom. 		

<p>8</p>	<p>Living Quarters</p> <ul style="list-style-type: none"> - Existing beds: 7. - During training, living facility is insufficient. Would prefer to provide separate gender bathrooms and bedrooms. - Prefer Day Room to have separation from Dining and Kitchen - Kitchen size is currently sufficient. Would like to have commercial-grade dish washer. - Current pantry storage space insufficient. - Dining table some time is used for meetings. During having maximum staffing, some people dine in the Day Room. - Outdoor patio needs wind and insect screen protection in the coastal area. - Prefer commercial-grade washer and dryer. 		
<p>9</p>	<p>Programming Report</p> <ul style="list-style-type: none"> - Ratcliff to explore possibly 4 options: <ul style="list-style-type: none"> o Option A: Renovating existing fire station – occupied site (need phased planning) o Option B: Renovation existing fire station – unoccupied site (need temp site) o Option C: : Renovation existing fire station – with a remote mini station concept. (need remote site) o Option D: New fire station at a new location (need new site TBD). - Ratcliff to incorporate sustainable features. 		
<p>10</p>	<p>Aesthetic</p> <ul style="list-style-type: none"> - Not deeply discussed, but some preference for association with local rural structures was mentioned. 		

These minutes summarize the conclusions of the subject meeting. If there are substantial errors or omissions, please contact Ratcliff within three working days of receipt of this memorandum

Nina Pakanant
 Ratcliff

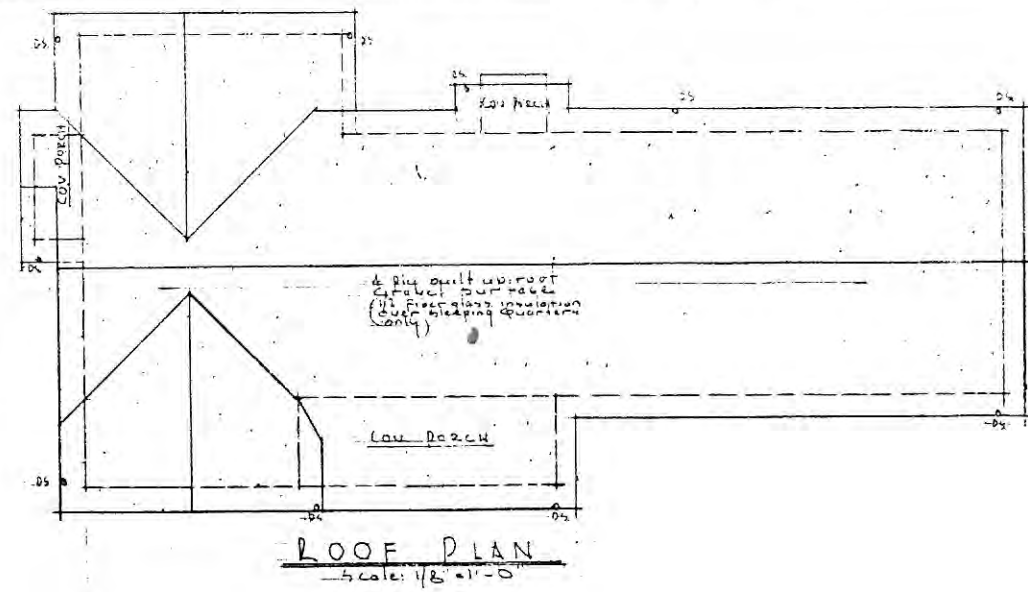

ROOF PLAN
Scale: 1/8" = 1'-0"

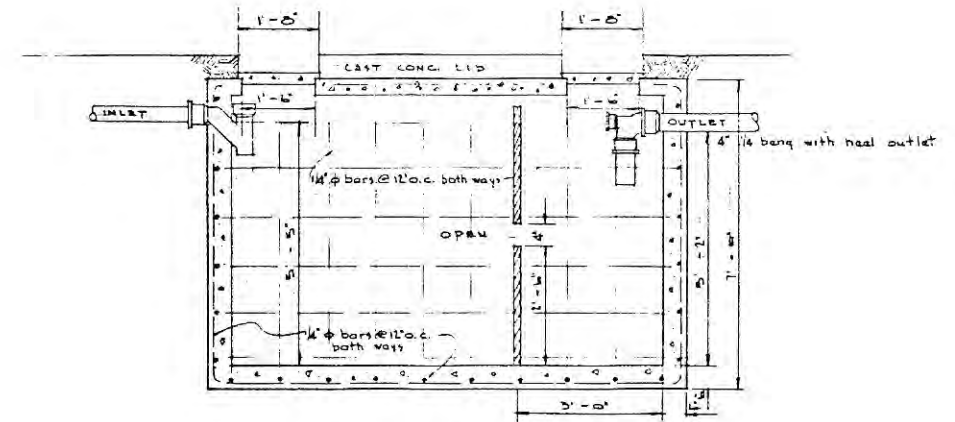

SECTION

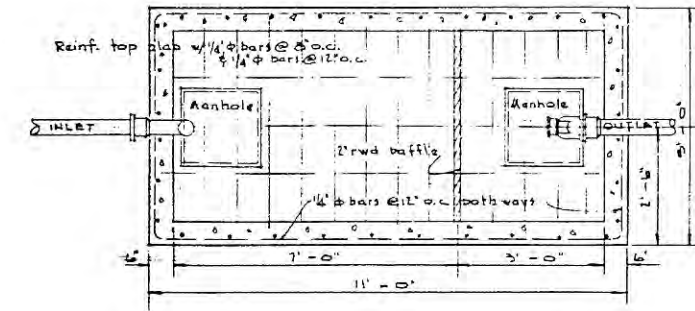

PLAN

SEPTIC TANK DETAILS



TYPICAL TRENCH DETAILS

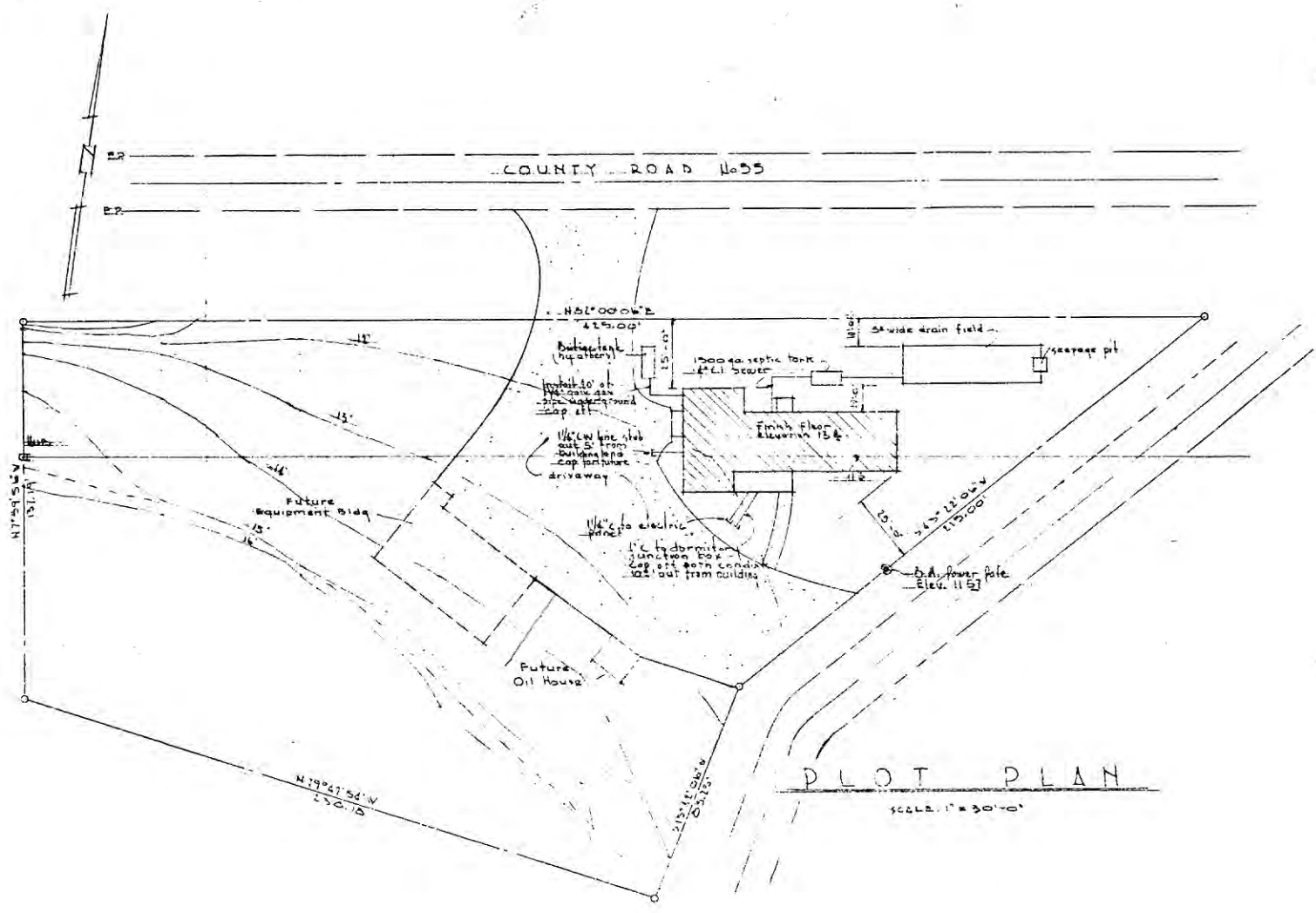

PLOT PLAN
Scale: 1" = 30'-0"

Approved by	LIVING QUARTERS	DATE
FIRE WAGON	FOR RESIDENTS	1-7-57
HAN BODY ENGINEER	FIRE STATION	SCALE
COUNTY ASSOCIATE	SAN MATEO COUNTY	DATE
CONSTRUCTION	DEPARTMENT	1-7-57
	CONSTRUCTION & MAINTENANCE	FILE NO.

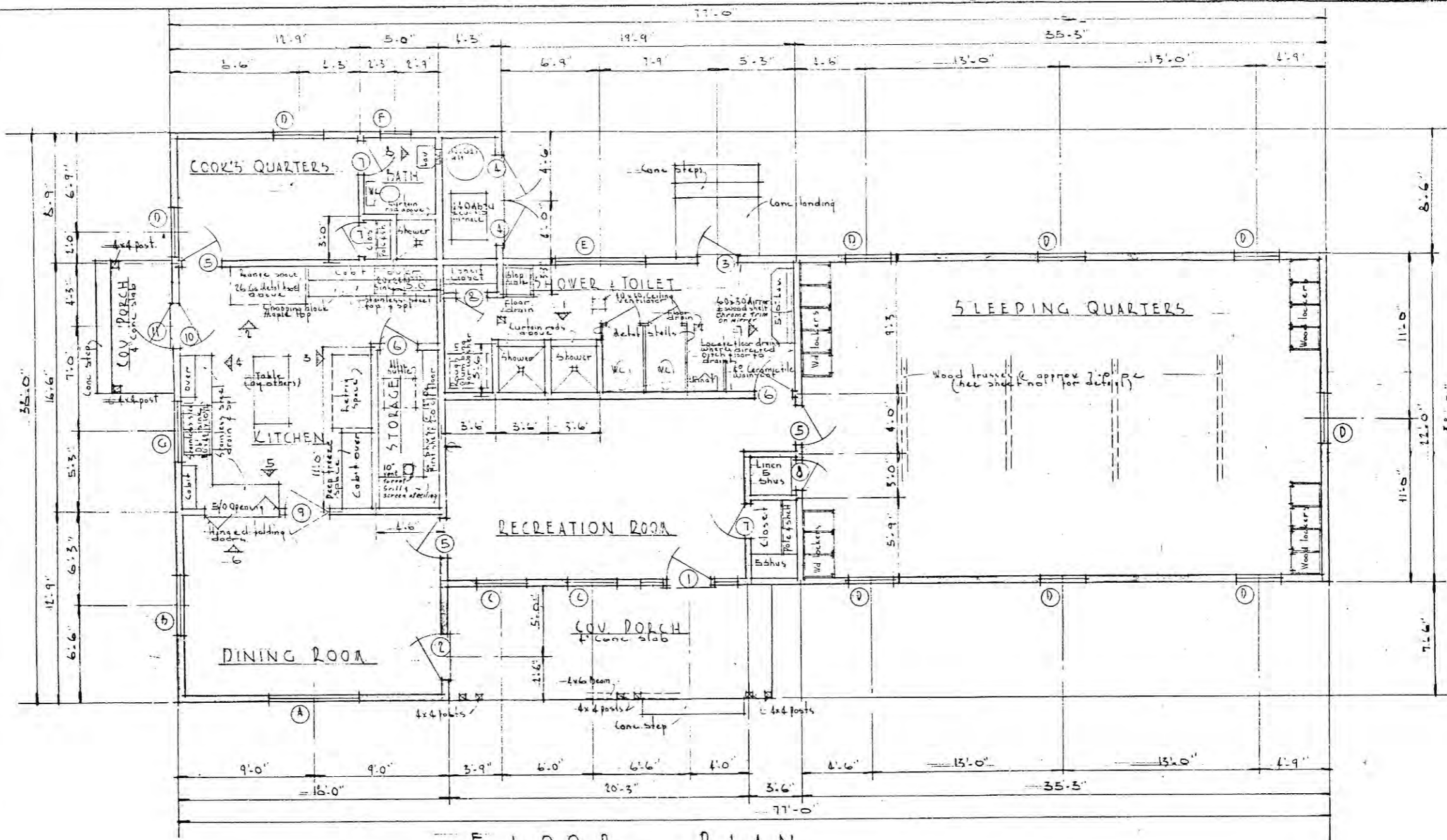

FLOOR PLAN
 Scale: 1/4" = 1'-0"
 See sheet no. 3 for truss detail

SCHEDULE OF ROOM FINISHES						
ROOM	FLOOR	BASE	WALLS	TRIM	CEILING	PAINTING SPECIFICATIONS
SLEEPING QUARTERS	Asphalt tile	Rubber base	Sheetrock painted	Wood	Painted ad ceiling Exposed truss painted	*1 & 2
DINING	(Green grout)	"	"	"	Sheetrock painted	*1 & 2
COOK'S QUARTERS	"	"	"	"	"	*1 & 2
KITCHEN	(Green grout)	"	"	"	"	*2 & 3
BATH	"	"	"	"	"	*2 & 3
SHOWERS TOILET	Ceramic tile to faucet	Ceramic tile	Ceramic tile	"	"	*2 & 3
STORAGE	Asphalt tile	Rubber base	Sheetrock painted	"	"	*1 & 2
CLOSET	"	"	"	"	"	*1 & 2
RECREATION	"	"	"	"	"	*1 & 2
FURNACE	1" conc slab	None	5/8" sheetrock no paint	"	5/8" sheetrock no paint	*2

PAINTING NOTES:
 Interior woodwork shall be specification #2 except ceiling at sleeping room which shall be #1
 Interior walls & ceilings shall be specification #1 except in kitchen, bath & toilets which shall be #3
 Interior woodwork shall be specification #2
 Exterior metal shall be specification #4

WINDOW SCHEDULE			
NO	SIZE	TYPE	NOTES
A	6'-0" x 4'-11 1/8"	Alum Casement	All glass shall be "B" Quality type Double Strength
B	4'-0" x 4'-2 1/8"	"	"
C	5'-0" x 4'-2 1/8"	"	"
D	3'-2" x 3'-2 1/8"	"	"
E	6'-0" x 3'-2 1/8"	"	1 pane muntin secure glass in the center pane 2 panes in the side panes
F	3'-0" x 2'-2"	"	Opaque glass
G	4'-0" x 3'-2 1/8"	"	"

Furnish one screen for each vented window

DOOR SCHEDULE			
NO	SIZE	TYPE	NOTES
1	5'-0" x 6'-8" 13/4"	DF 9 Lite	same spec. as 11, 12, 13, 14, 15, 16, 17, 18, 19, 20, 21, 22, 23, 24, 25, 26, 27, 28, 29, 30, 31, 32, 33, 34, 35, 36, 37, 38, 39, 40, 41, 42, 43, 44, 45, 46, 47, 48, 49, 50, 51, 52, 53, 54, 55, 56, 57, 58, 59, 60, 61, 62, 63, 64, 65, 66, 67, 68, 69, 70, 71, 72, 73, 74, 75, 76, 77, 78, 79, 80, 81, 82, 83, 84, 85, 86, 87, 88, 89, 90, 91, 92, 93, 94, 95, 96, 97, 98, 99, 100
2	5'-0" x 6'-8" 13/4"	DF	Furnish solid core
3	2'-8" x 6'-8" 13/4"	DF Hollowwood	Secure glass
4	3'-0" x 6'-8" 13/4"	DF	Furnish solid core
5	2'-8" x 6'-8" 13/4"	DF	Hollow core
6	2'-6" x 6'-8" 13/4"	DF	"
7	2'-4" x 6'-8" 13/4"	DF	"
8	2'-0" x 6'-8" 13/4"	DF	"
9	3'-0" x 6'-8" 13/4"	DF Double acting	Secure glass, secure core & secure panel
10	5'-0" x 6'-8" 13/4"	DF Lite	Furnish solid core
11	3'-0" x 6'-8" 13/4"	DF	"

APPROVED BY	LIVING QUARTERS FOR RE-ENTRY FIRE DETENTION	DATE
FILE NUMBER		1-17-57
COUNTY MANAGER	SAN MATEO COUNTY DEPARTMENT OF CONSTRUCTION	DATE
DATE OF ISSUE		1-17-57
CONTRACT NO.		FILE NO.

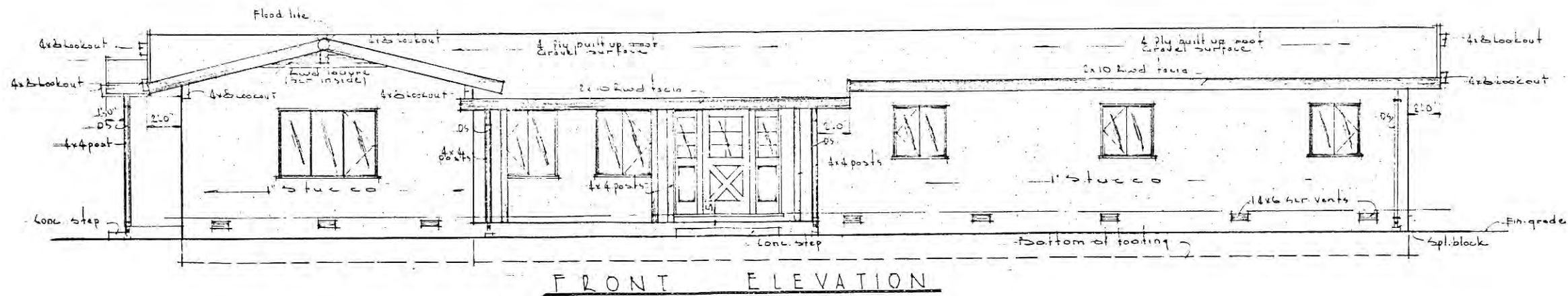

FRONT ELEVATION

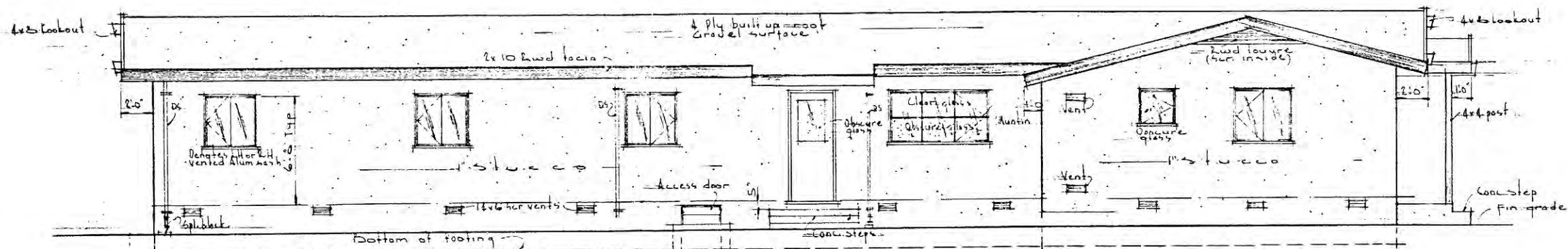

REAR ELEVATION

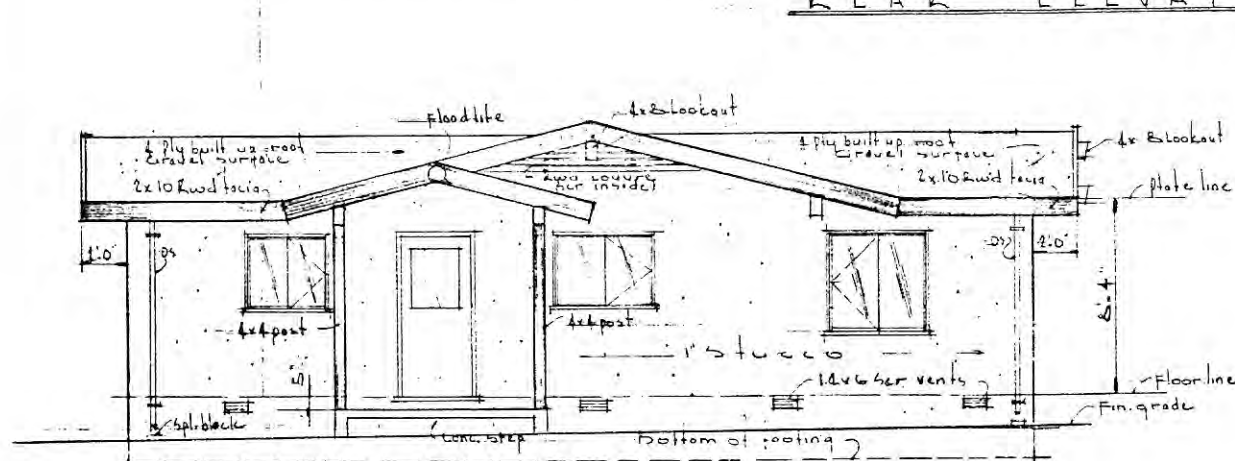

LEFT ELEVATION

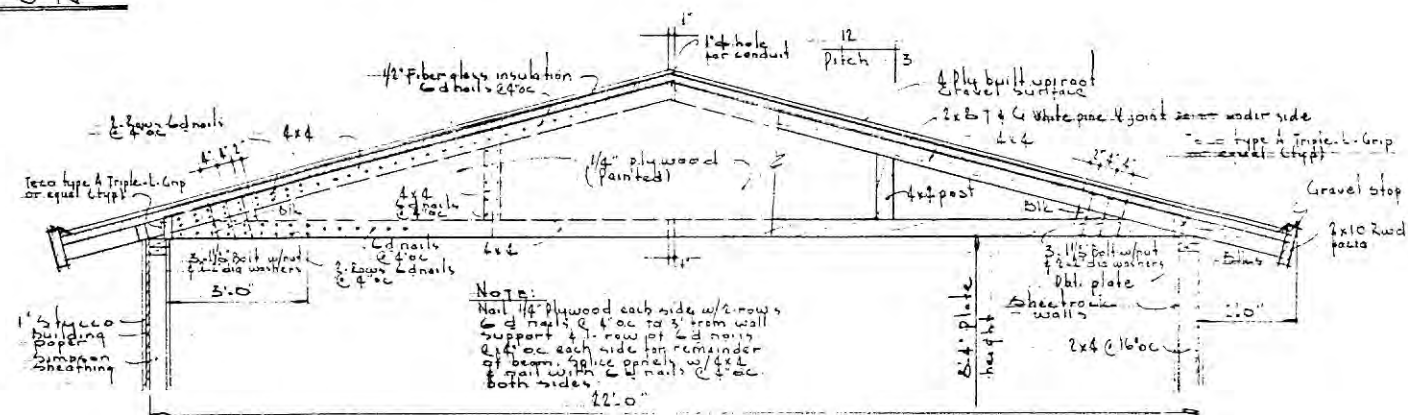

TRUSS DETAIL AT SLEEPING QUARTERS

Scale: 1/2" = 1'-0"

Truss detail only by FRED L. HASTING - CIVIL ENGINEER

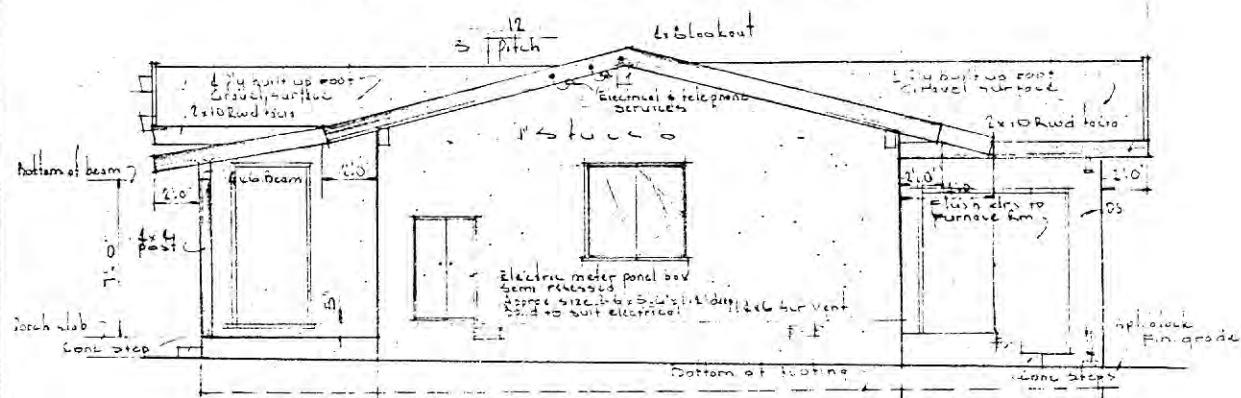

RIGHT ELEVATION

EXTERIOR ELEVATIONS



Approved by	LIVING QUARTERS FOR RESCUE FIRE STATION	DATE 2-7-37
PREPARED BY	FRED L. HASTING	SCALE Noted
CHECKED BY		DRAWN BY A.C.A.
DESIGNED BY		
CONSTRUCTION & MAINTENANCE		

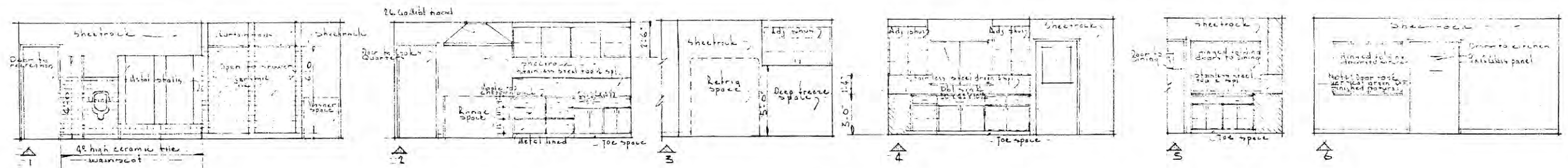

INTERIOR ELEVATIONS

Scale: 1/4" = 1'-0"

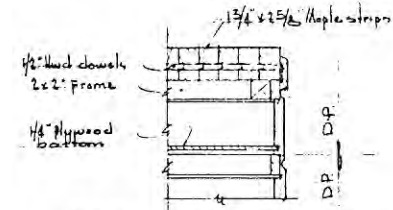
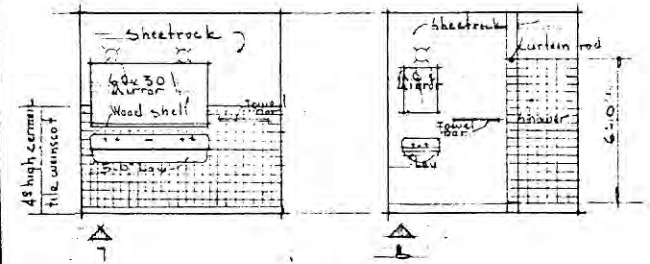

DETAIL AT CUTTING BLOCK

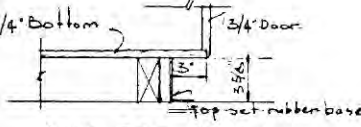

TYP TOE SPACE

Scale: 1/2" = 1'-0"

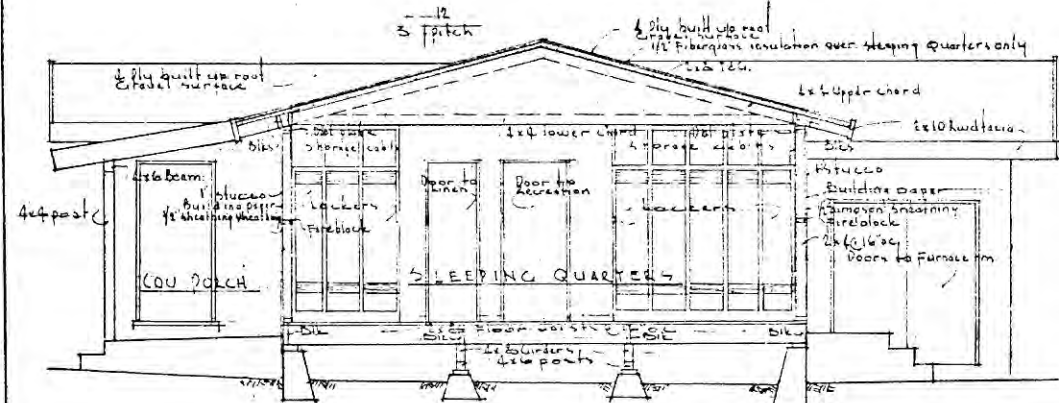

SECTION X

Scale: 1/4" = 1'-0"

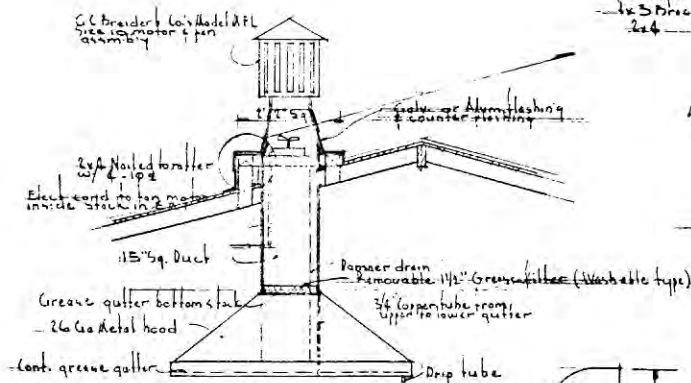

HOOD & EXHAUST FAN DETAIL

Scale: 1/2" = 1'-0"

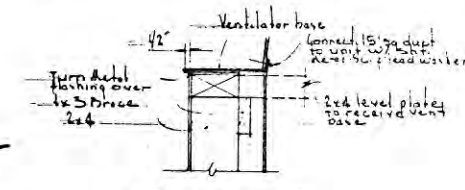

TYP VENT/DOOR DETAIL

Scale: 1/2" = 1'-0"

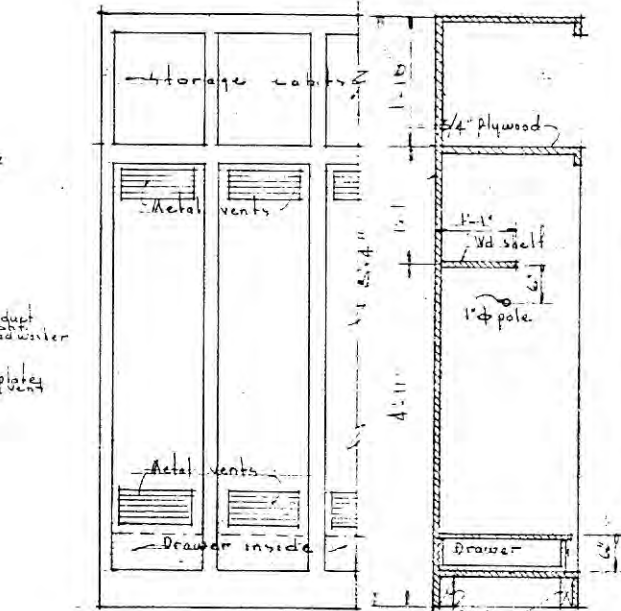

ELEVATION

SECTION

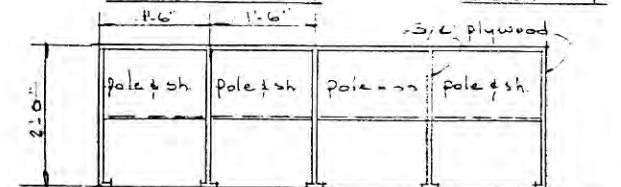

PLAN

LOCKERS' DETAILS

Scale: 3/4" = 1'-0"

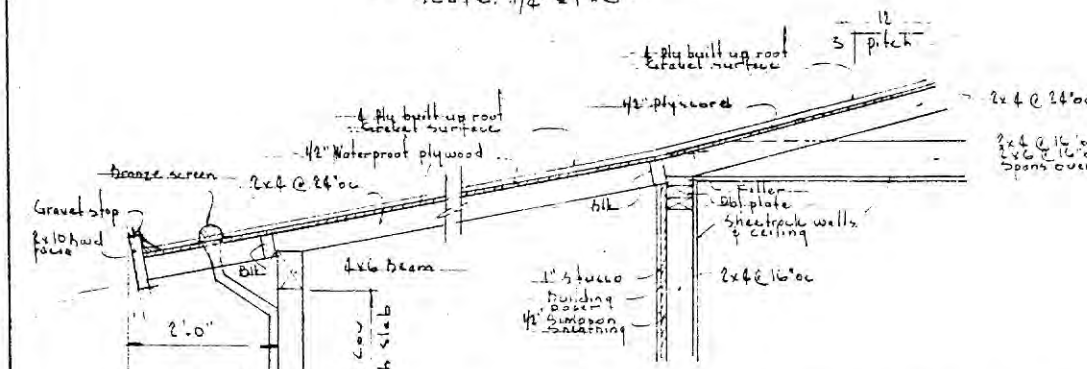

EAVE AT COV PORCH & RECREATION RM

Scale: 3/4" = 1'-0"

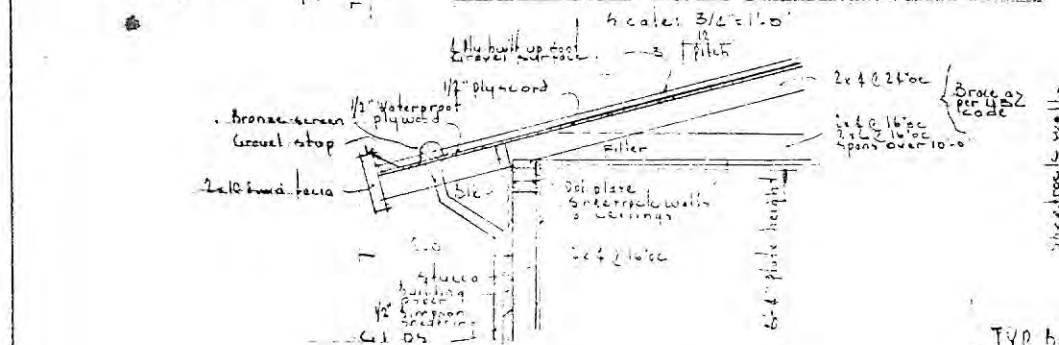

TYP BASE DETAIL AT CERAMIC TILE FLOOR

Scale: 3/4" = 1'-0"

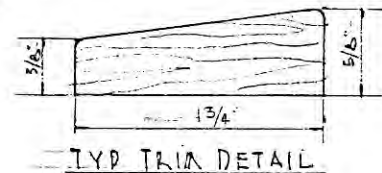

TYP TRIM DETAIL

Scale: 3/4" = 1'-0"

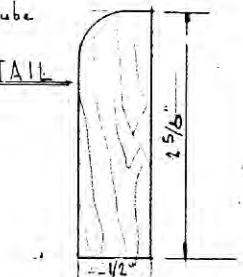

TYP BASE DETAIL

Scale: 1/2" = 1'-0"

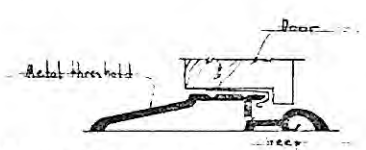

WEATHERSTRIP DETAIL AT EXTERIOR DOOR

Scale: 6" = 1'-0"

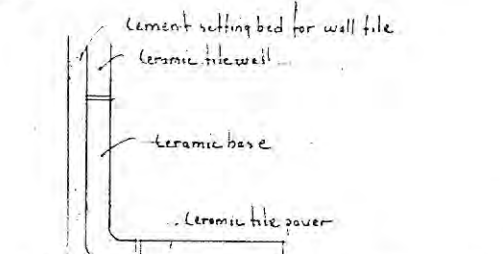

DETAIL AT CERAMIC TILE WAINSCOT

Scale: 3/4" = 1'-0"

APPROVED BY	LIVING QUARTERS	DATE
FIRE WARDEN	FOR READERO	NOV 21 1951
MAN AG OF SUPPLIANCE	FIRE STATION	
COUNTY ENGINEER	SAN JUAN COUNTY	
FOR CHIEF OF COUNTY	DEPARTMENT OF	
	CONSTRUCTION & REPAIRS	

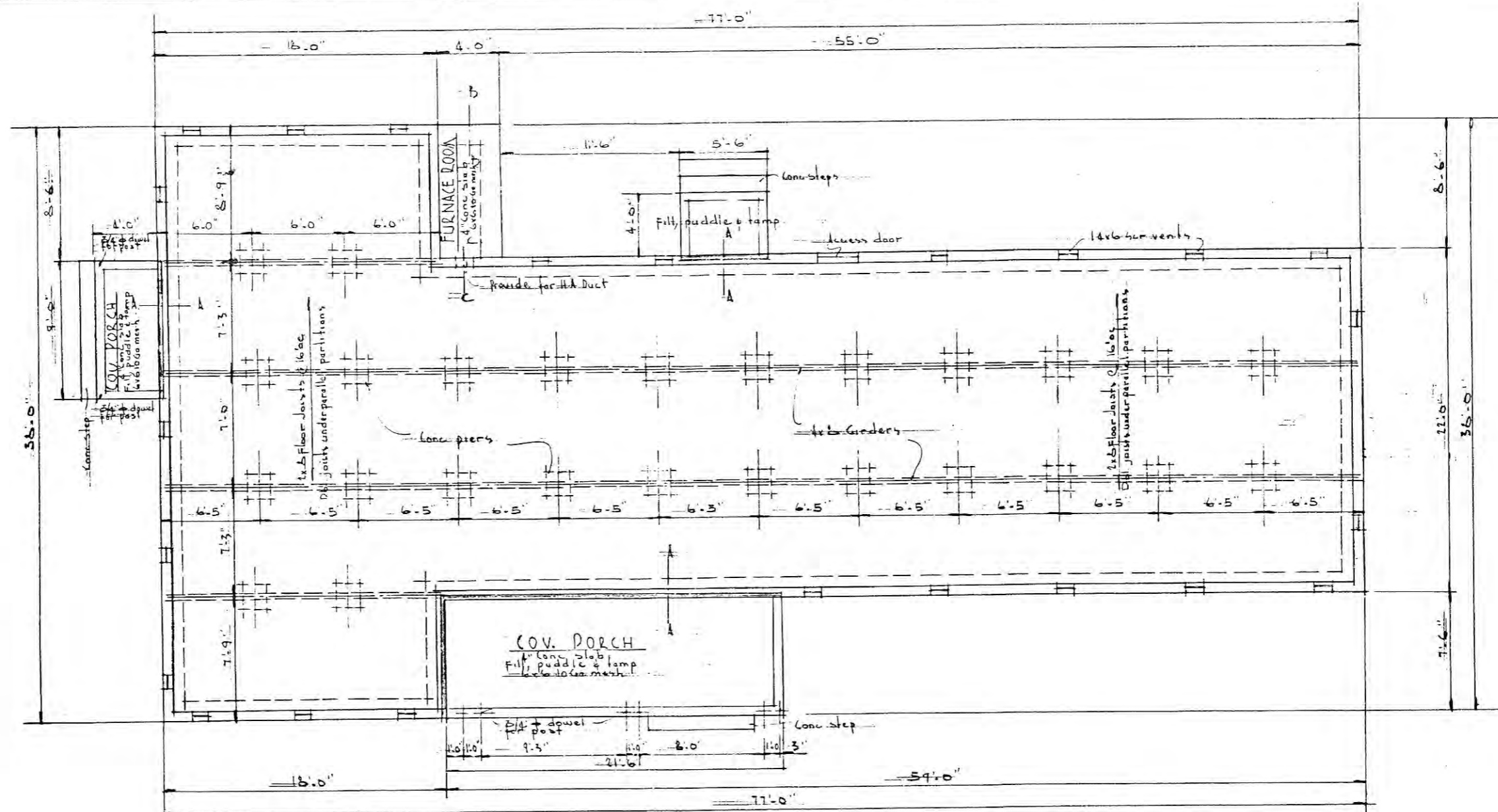

FOUNDATION PLAN

Scale: 1/4" = 1'-0"

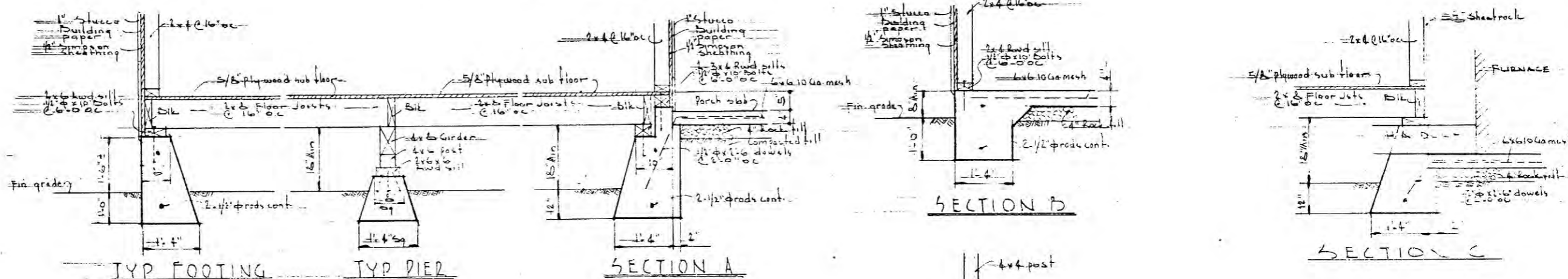

FOUNDATION DETAILS

Scale: 3/4" = 1'-0"

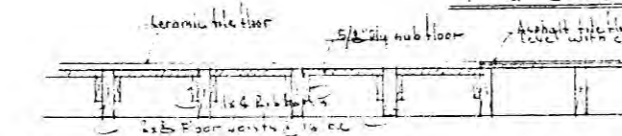

FLOOR DETAIL FOR TILE FLOOR
Scale: 3/4" = 1'-0"

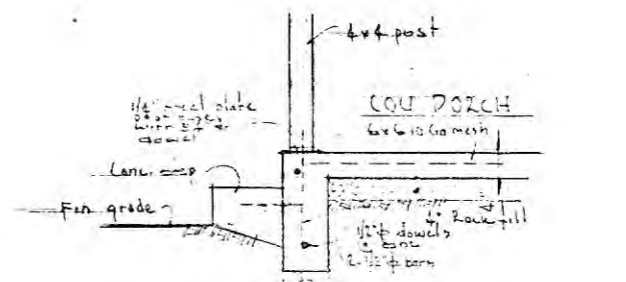

POST DETAIL AT COV. PORCH
Scale: 3/4" = 1'-0"

APPROVED BY	LIVING QUARTERS FOR DESLDERO FIRE SECTION	DATE 2-17-37
FIRE WARDEN		SCALE NOTED
COUNTY ENGINEER		DESIGNED BY H. J. ...
HENRY ...	TAN ... CITY DEPARTMENT OF CONSTRUCTION	CHECKED BY H. J. ...

ELECTRICAL FIXTURE SCHEDULE

- A THOMAS INDUSTRIES INC., STEELIGHT #T1-219-4 20WATT LAMPS
- B CRYSTAR HONEY AREA LIGHT 24x24 PLASTIC GLASS CEILING LAMPS
- C LIGHTOLIER, OPALITE 4317 2-75 WATT LAMPS
- D THOMAS INDUSTRIES INC., STEELIGHT #T1-135 2-20 "
- E " " " #6L-143 2-60 "
- F " " " #T1-151 1-40 "
- G STEBER UTILITE FLOODLIGHT 5300 1-240 LAMP
- H LIGHTOLIER, OPALITE 4318 3-60 WATT LAMP
- I 1/4" PORCELAIN SOCKET, KEY-BAY OR PULL AS REQUIRED 1-75W LAMP
- J 3-STEBER LITES AND FITTINGS 5300 3-R40 LAMPS

NOTE
Telephone, Electrical Contractor shall furnish and install all equipment, boxes and conduits necessary for the telephone system.

- SYMBOLS**
- ⊙ Outlet well or ceiling
 - ⊕ Duplex convenience outlet
 - ⊕ WP Weatherproof convenience outlet
 - ⊕ Clock outlet (110 volts)
 - ⊕ P.T.T. Telephone
 - ⊕ Intercom & radio
 - ⊕ Push button
 - ⊕ Buzzer or bell as selected
 - e Switches on emergency circuit (see specs)

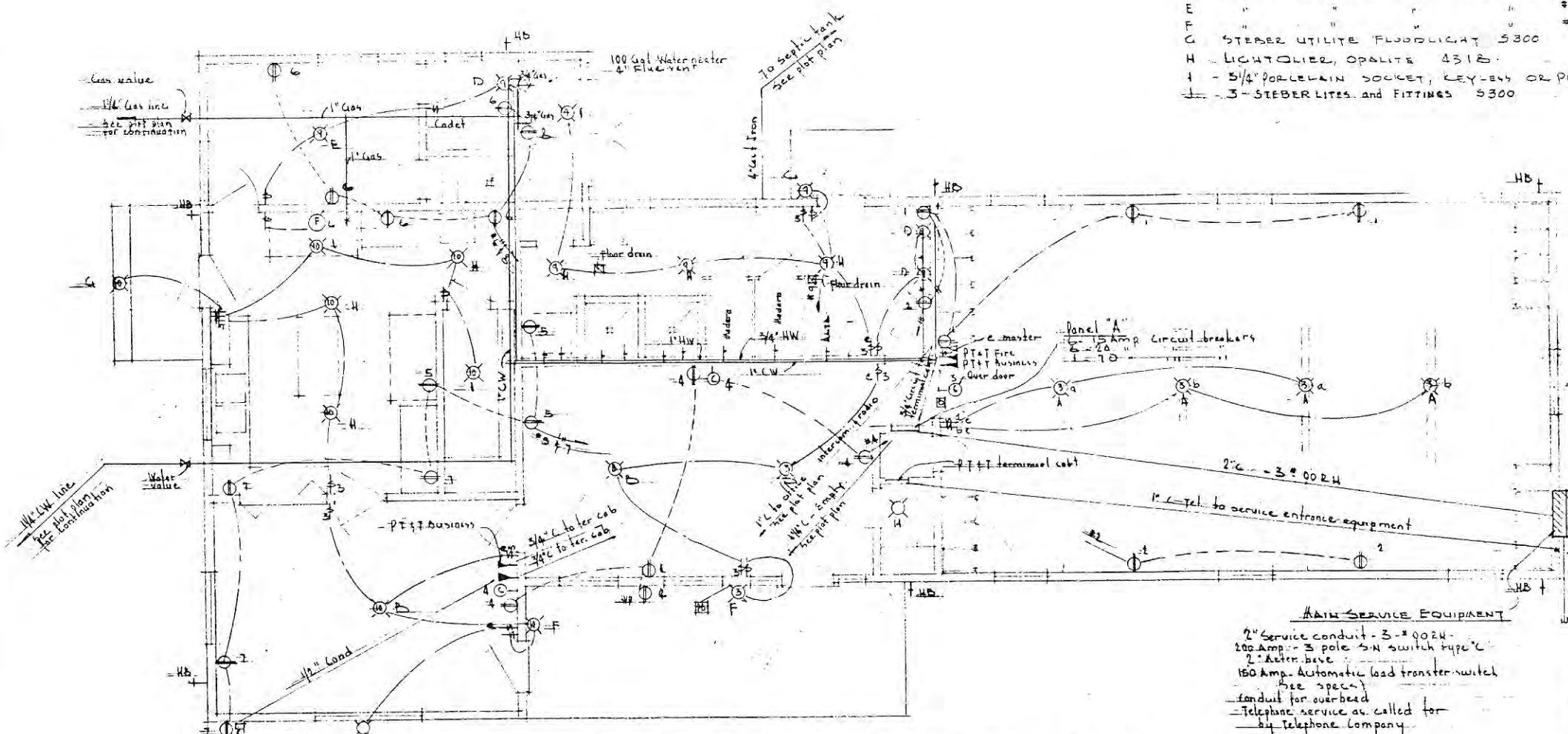

ELECTRICAL & PLUMBING PLAN
Scale: 1/4" = 1'-0"

MAIN SERVICE EQUIPMENT
2" Service conduit - 3 # 0024
200 Amp - 3 pole S.W. switch type "C"
2" Meter base
150 Amp. Automatic load transfer switch (see spec)
Conduit for overhead
Telephone service as called for by Telephone Company

PLUMBING NOTES:
Hot & cold water supply to water heater shall be 1"
Hot & cold feeder lines shall be of size shown on plans
Taps for fixtures & hose bibbs shall be sized in accordance with SAN MATEO COUNTY PLUMBING CODE
Pressure on system shall be 30 lbs
Rough in only for washing machine
Gas line shall be as shown on plans
Waste and venting shall be in accordance with SAN MATEO COUNTY CODE and shall be complete with septic tank & drain field as shown on plans
See plot plan for extensions of

HEATING NOTES:
1. Floor supply diffusers shall be TITTLE & BAILEY T-60 with adjustable dampers
2. Return air registers shall be TITTLE & BAILEY AEROWANE MODEL 7 TB or equal with opposed blade dampers
3. Return air ducts shall be in 2" space, supply ducts under floor

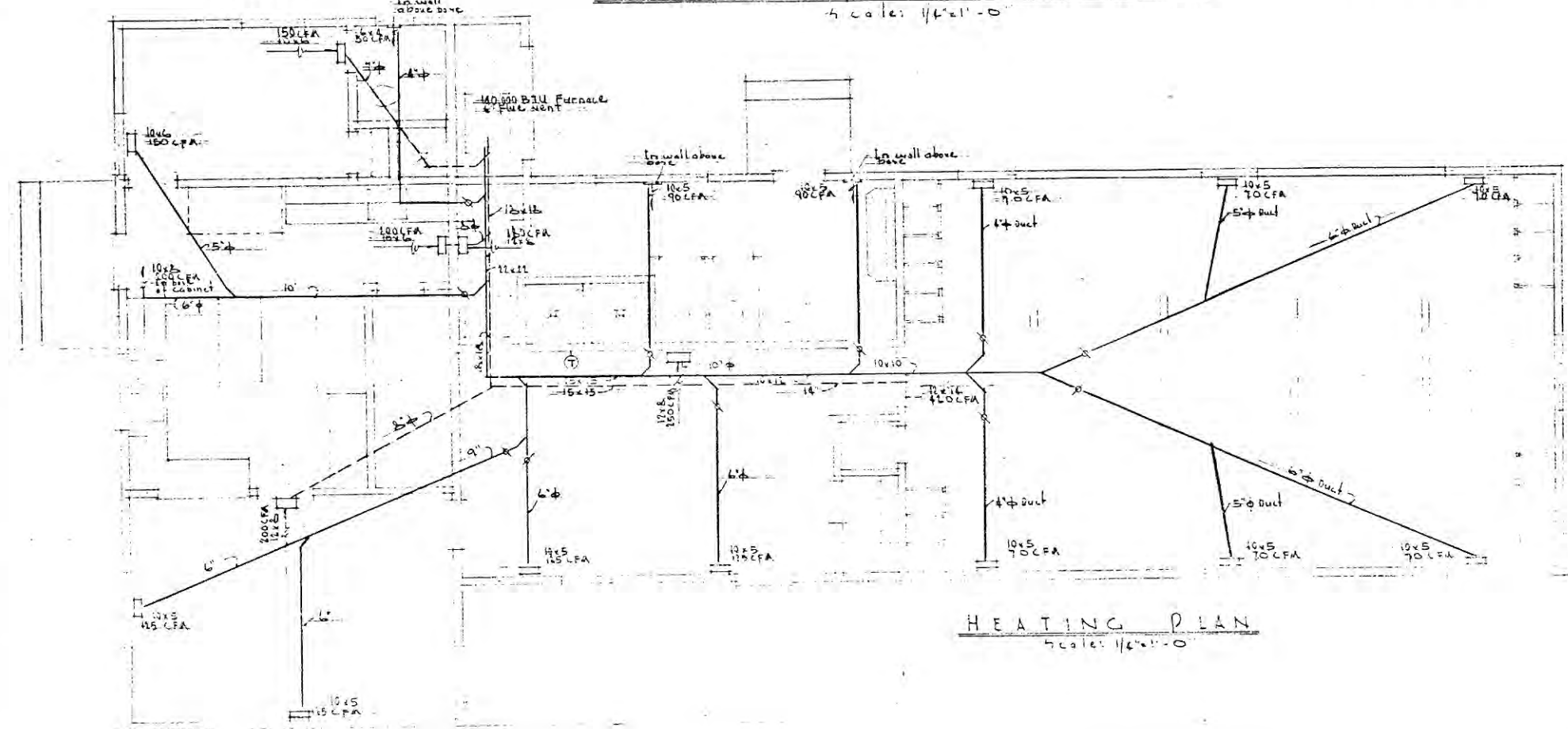

HEATING PLAN
Scale: 1/4" = 1'-0"

- LEGEND**
- Supply Air
 - - - Return Air
 - ⊕ Volume damper
 - ⊕ Room Thermostat

Approved by	LIVING QUARTERS FOR RESIDENTS FIRE STATION	Date
Fire Warden		1-1-57
Checked by	REGISTERED CONSTRUCTION & CONTRACTING	Scale
MAN OF SUPERVISOR		Noted
Checked by	REGISTERED CONSTRUCTION & CONTRACTING	Checked by
Checked by		Checked by

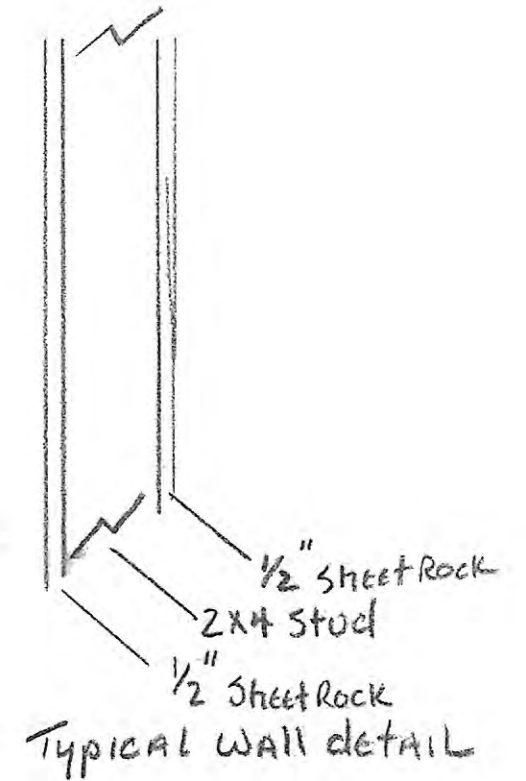
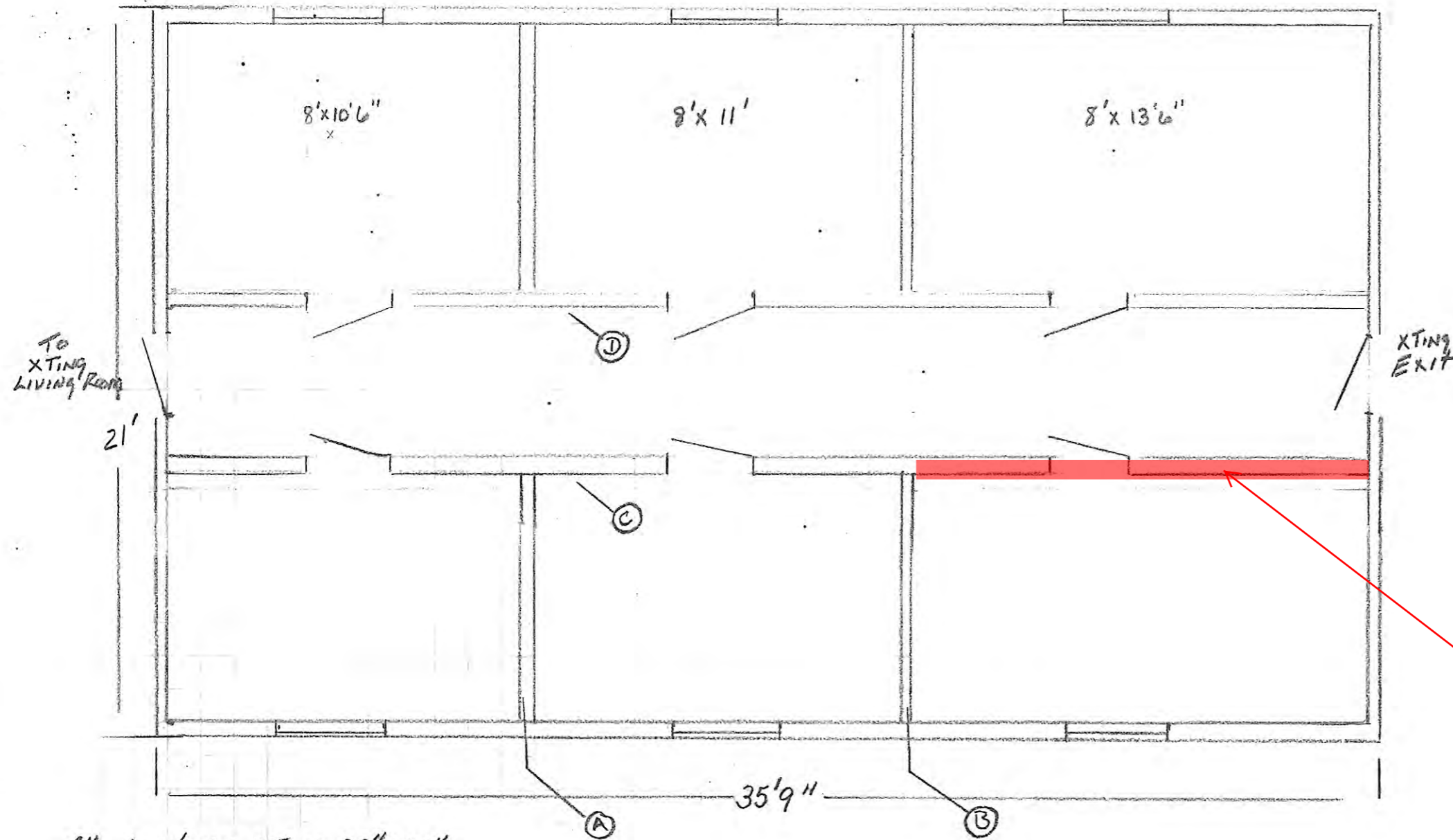

This wall was not built.
Confirmed on 11/20/13.
Note:
"xting" means "Existing Condition"

All windows xting 30"x38"
All doors 30" Hollow Core
All walls insulated for sound resistance

Walls A, C, D New Partitions
Wall B Xting Partition

Date of Drawing:
Unknown

1/4" scale
D. Risney
Pescadero Fire Station
BARRACKS

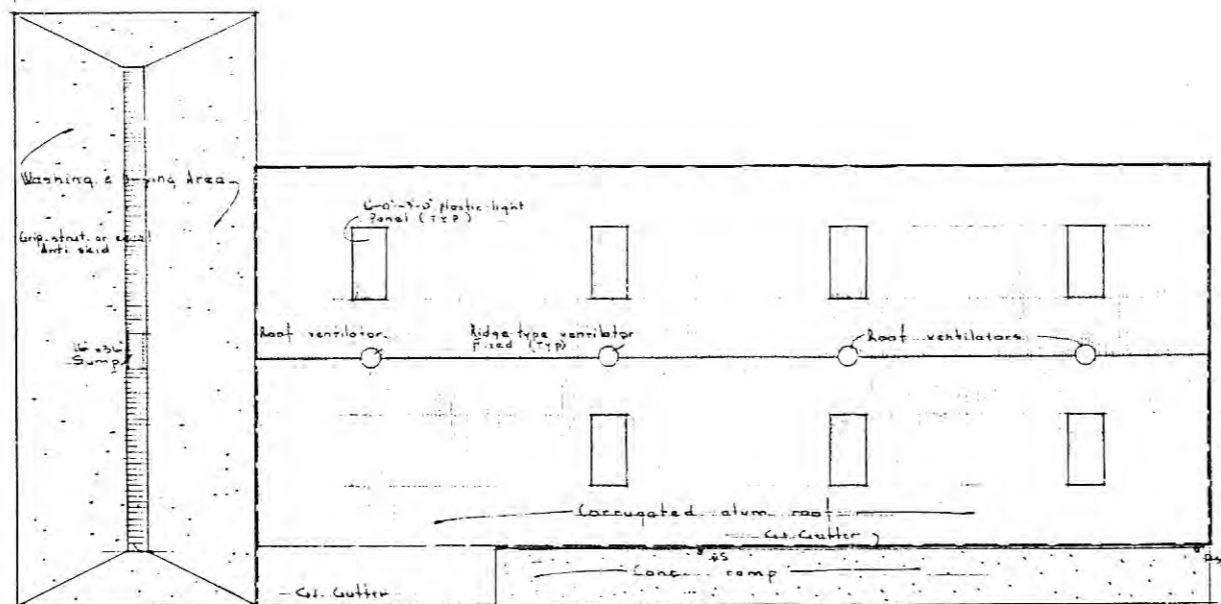

ROOF PLAN

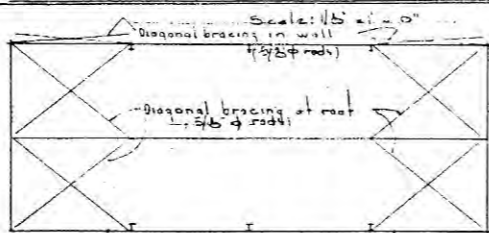

DIAGONAL BRACING DETAIL

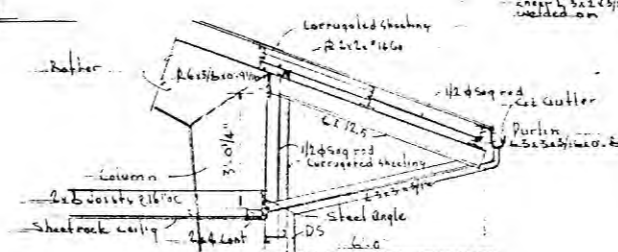

CANOPY AT OFFICE FLY

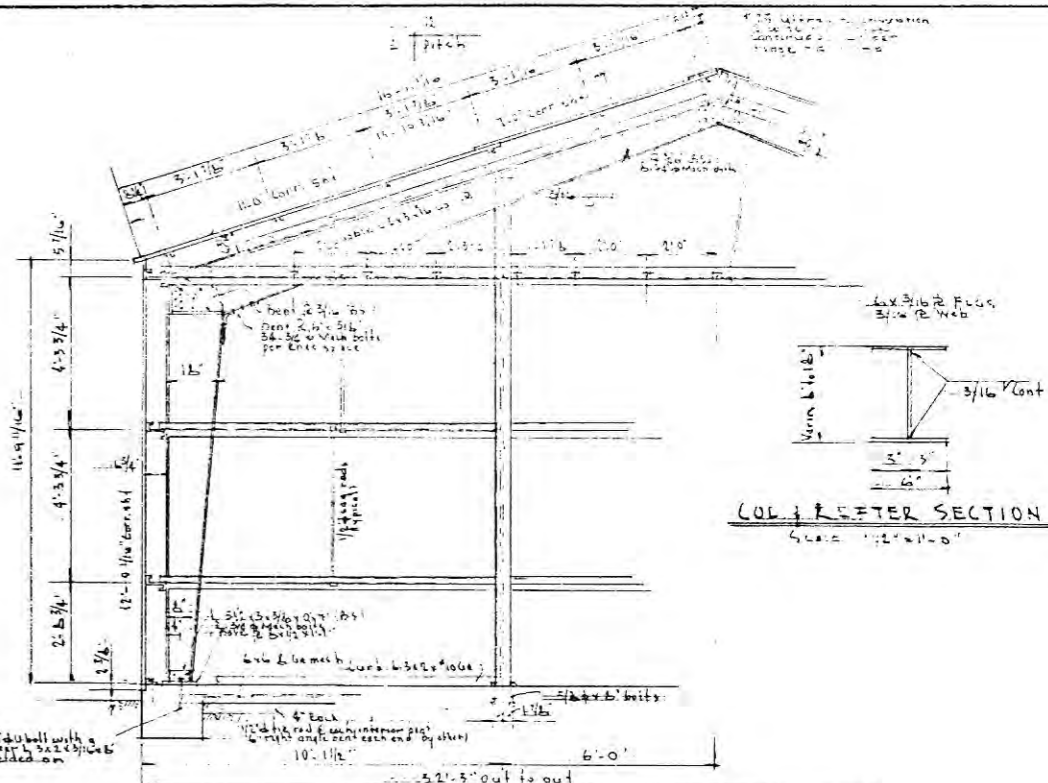

TYPICAL BENT END WALL FRAMING

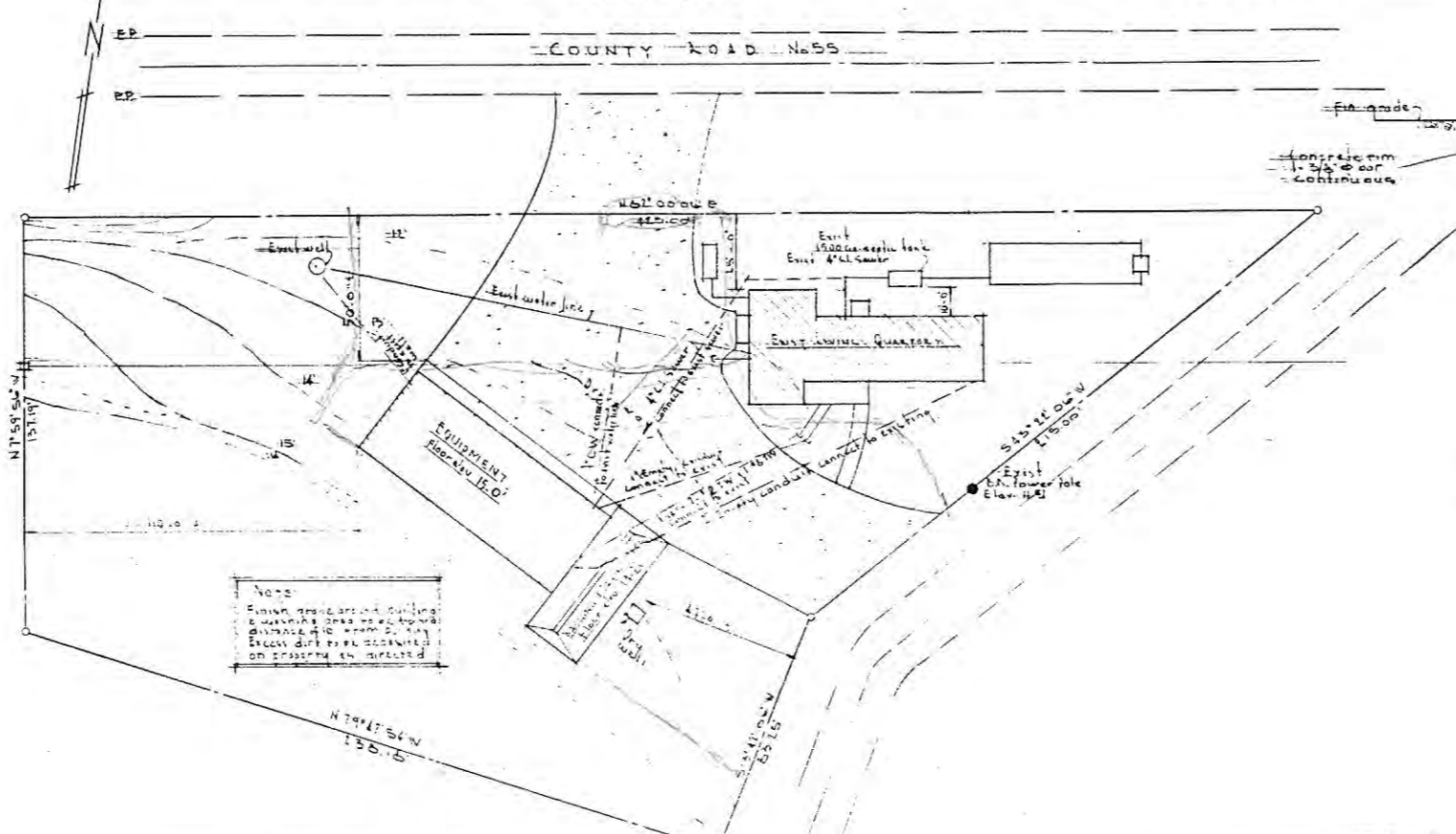

SITE PLAN

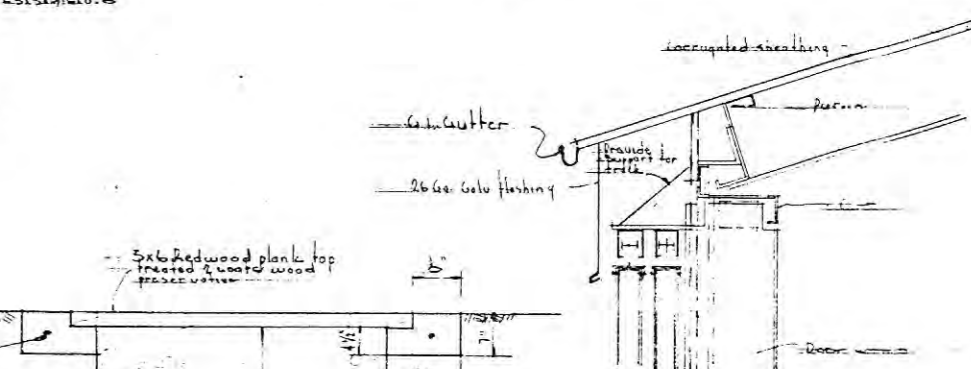

ELEVATION

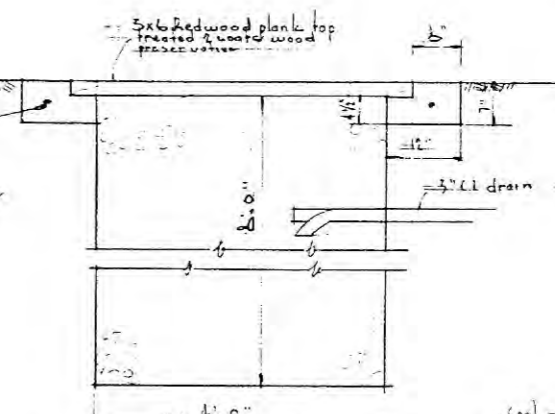

DRAINAGE SUMP DETAIL

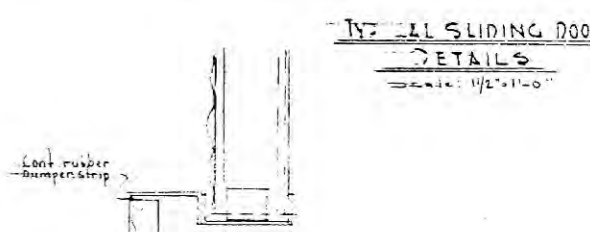

SLIDING DOOR DETAILS

Note:
Finish specifications and building
& materials data as shown
throughout this drawing shall
include dirt to be delivered
on property to project.

DESIGNED BY	WASHINGTON & MITCHELL
FILE NUMBER	VEGASERO'S SE STATION
PROJECT NAME	EQUIPMENT STORAGE
COUNTY MANAGER	SAN MATEO COUNTY
DATE	DECEMBER 1955
SCALE	AS SHOWN

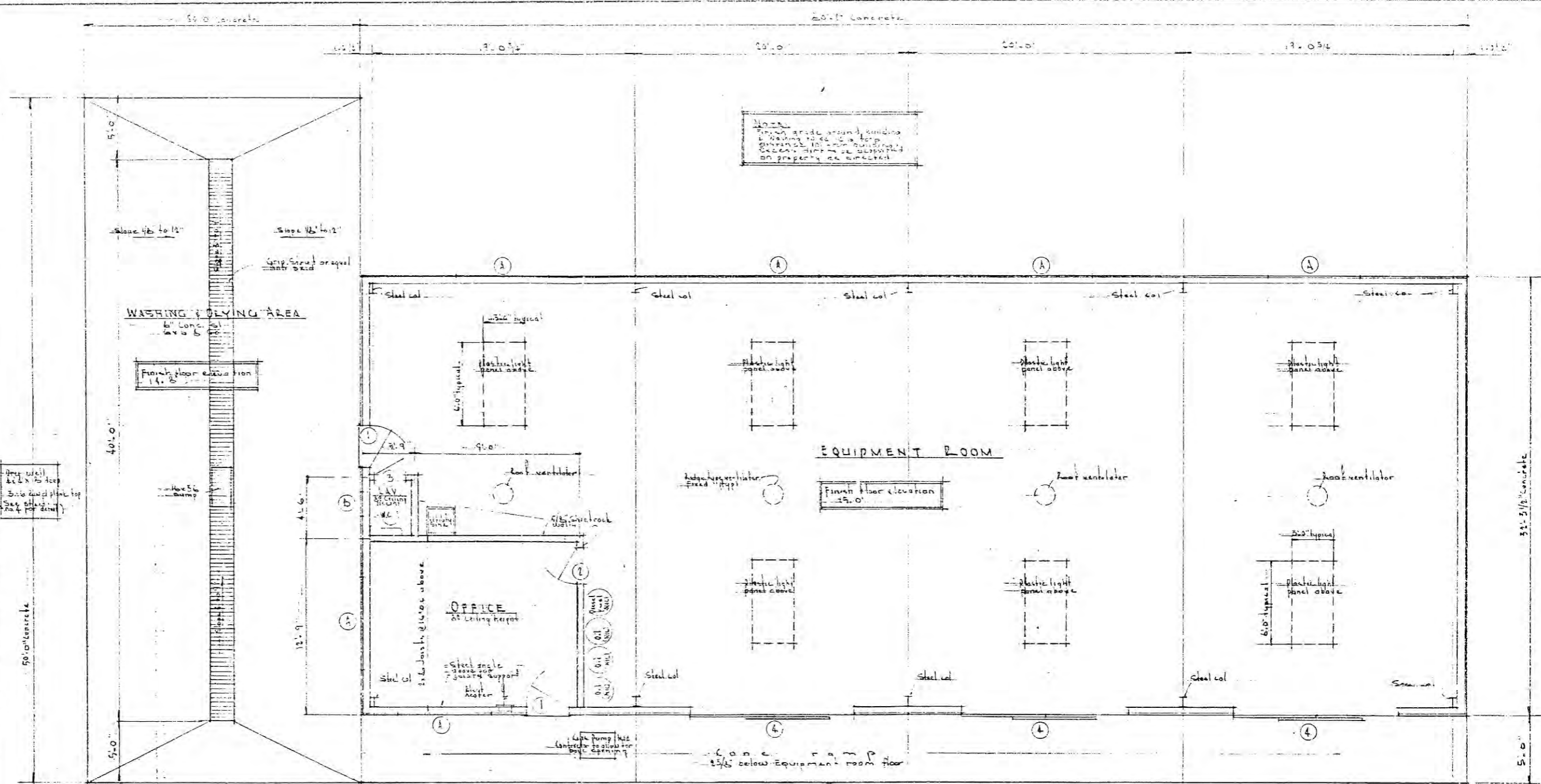

FLOOR PLAN
Scale: 1/4" = 1'-0"

SCHEDULE OF ROOM FINISHES						
ROOM	FLOOR	BASE	WALLS	TRIM	CEILING	PAINTING SPECIFICATIONS
EQUIPMENT	Concrete	None	1/2" x 1/2" x 1/2" metal mesh	Wood	Sheetrock	Interior walls & ceiling to be finished with 1/2" x 1/2" x 1/2" metal mesh
OFFICE	Concrete	Wood	1/2" x 1/2" x 1/2" metal mesh	Wood	Sheetrock	Interior walls & ceiling to be finished with 1/2" x 1/2" x 1/2" metal mesh
LAV	Concrete	Wood	1/2" x 1/2" x 1/2" metal mesh	Wood	Sheetrock	Interior walls & ceiling to be finished with 1/2" x 1/2" x 1/2" metal mesh

PAINTING NOTES:
Exterior & interior slope finishing - no paint
Structural steel shop coat only - no exterior weather
Exterior sides of doors & metal mesh Spec # 5
Interior sides of doors & metal mesh see schedule of room finishes above

WINDOW SCHEDULE			
No	SIZE	TYPE	NOTES
A	4'-0" x 4'-0"	Fixed	See schedule
B	4'-0" x 4'-0"	Fixed	See schedule
C	4'-0" x 4'-0"	Fixed	See schedule

FROM SOULE'S STEELING WINDOW CATALOG

DOOR SCHEDULE			
No	SIZE	TYPE	NOTE
1	4'-0" x 7'-0"	Swing	See schedule
2	4'-0" x 7'-0"	Swing	See schedule
3	4'-0" x 7'-0"	Swing	See schedule
4	4'-0" x 7'-0"	Swing	See schedule

WASHINGTON & MITCHELL
CIVIL AND STRUCTURAL ENGINEERS
408 SANSOME ST. SAN FRANCISCO 11

APPROVED BY	DESIGNED BY	DATE
FILE NUMBER	DESIGNED BY	DATE
DESIGNED BY	DESIGNED BY	DATE
DESIGNED BY	DESIGNED BY	DATE
DESIGNED BY	DESIGNED BY	DATE

DESIGNED BY: ESCOBAR - LE STATION
EQUIPMENT STORAGE
SAN MATEO COUNTY
DEPARTMENT OF
PUBLIC WORKS
SAN MATEO COUNTY
SAN MATEO COUNTY

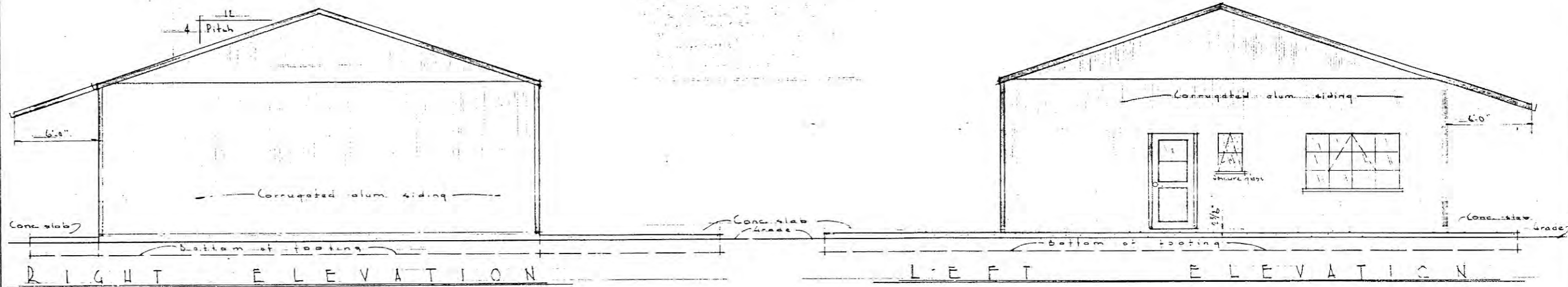
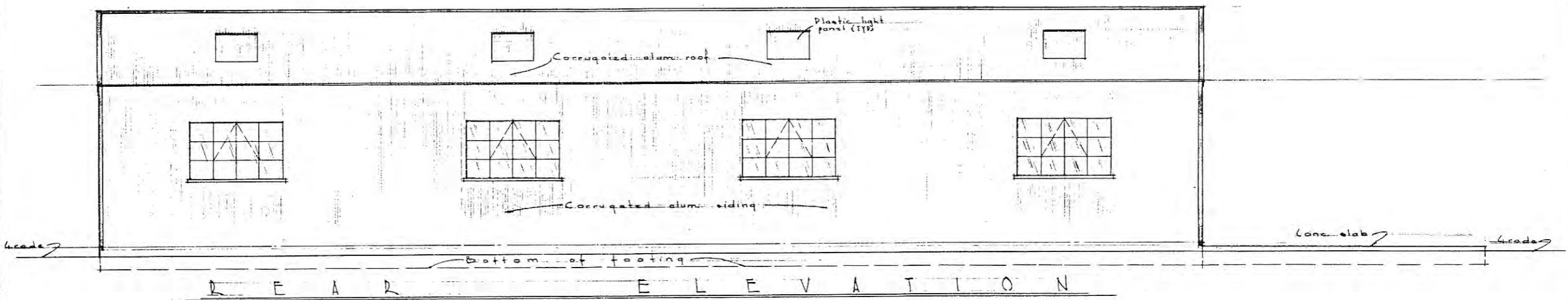
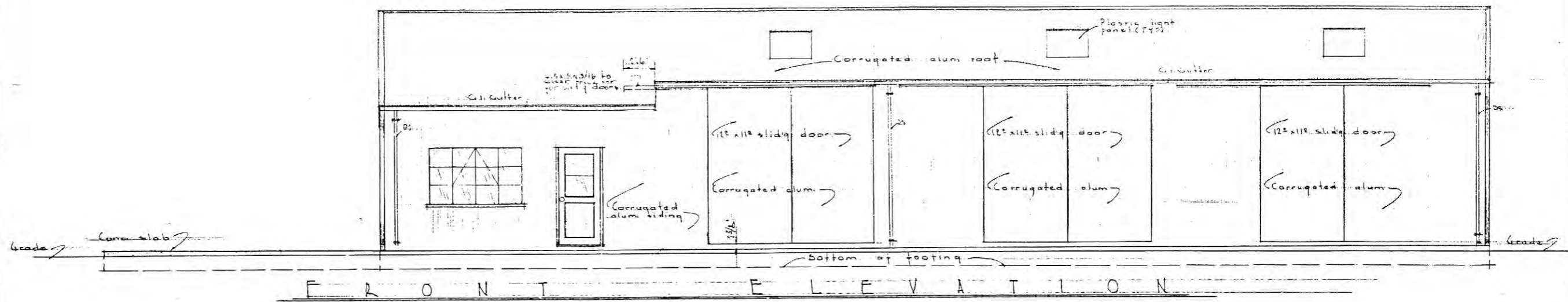

EXTERIOR ELEVATIONS

Scale: 1/4" = 1'-0"

WASHINGTON & MITCHELL
CIVIL AND STRUCTURAL ENGINEERS
405 BAYVIEW ST. SAN FRANCISCO 11

APPROVED BY	DESCALERO	DATE	11/1/51
FIRE WARDEN	EQUIPMENT STORAGE	SCALE	NATD
COUNTY MANAGER	BUILT	DESIGNED BY	W. J. MITCHELL
COUNTY MANAGER	SAN MATEO COUNTY	SHEET	B OF 5
DEPT. OF CONSTRUCTION & MAINTENANCE		FILE NO.	

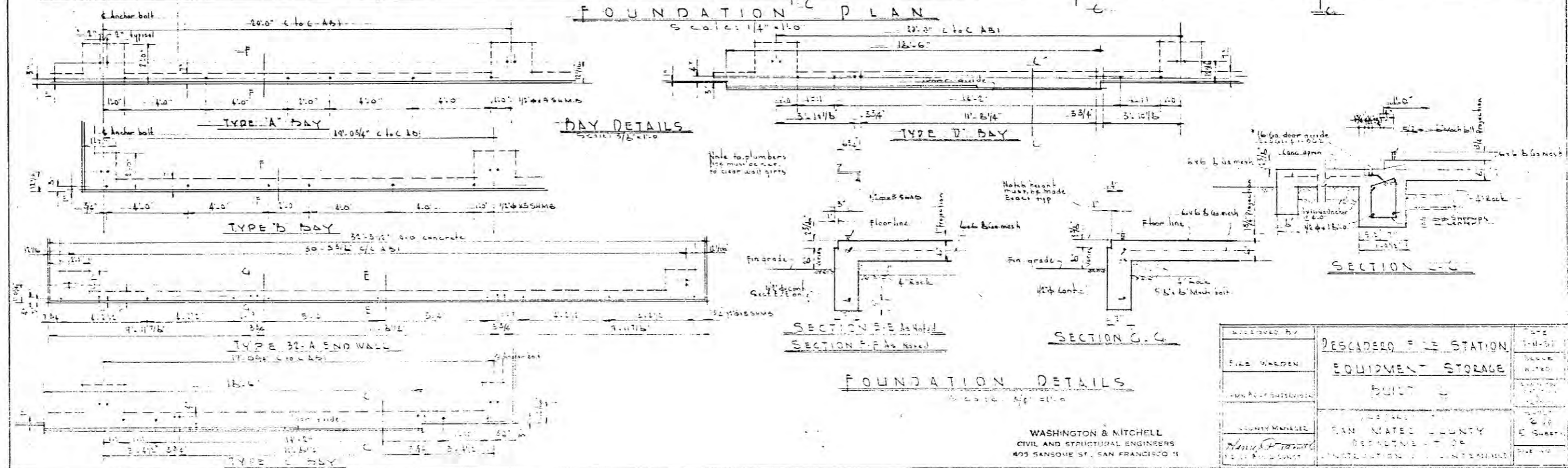
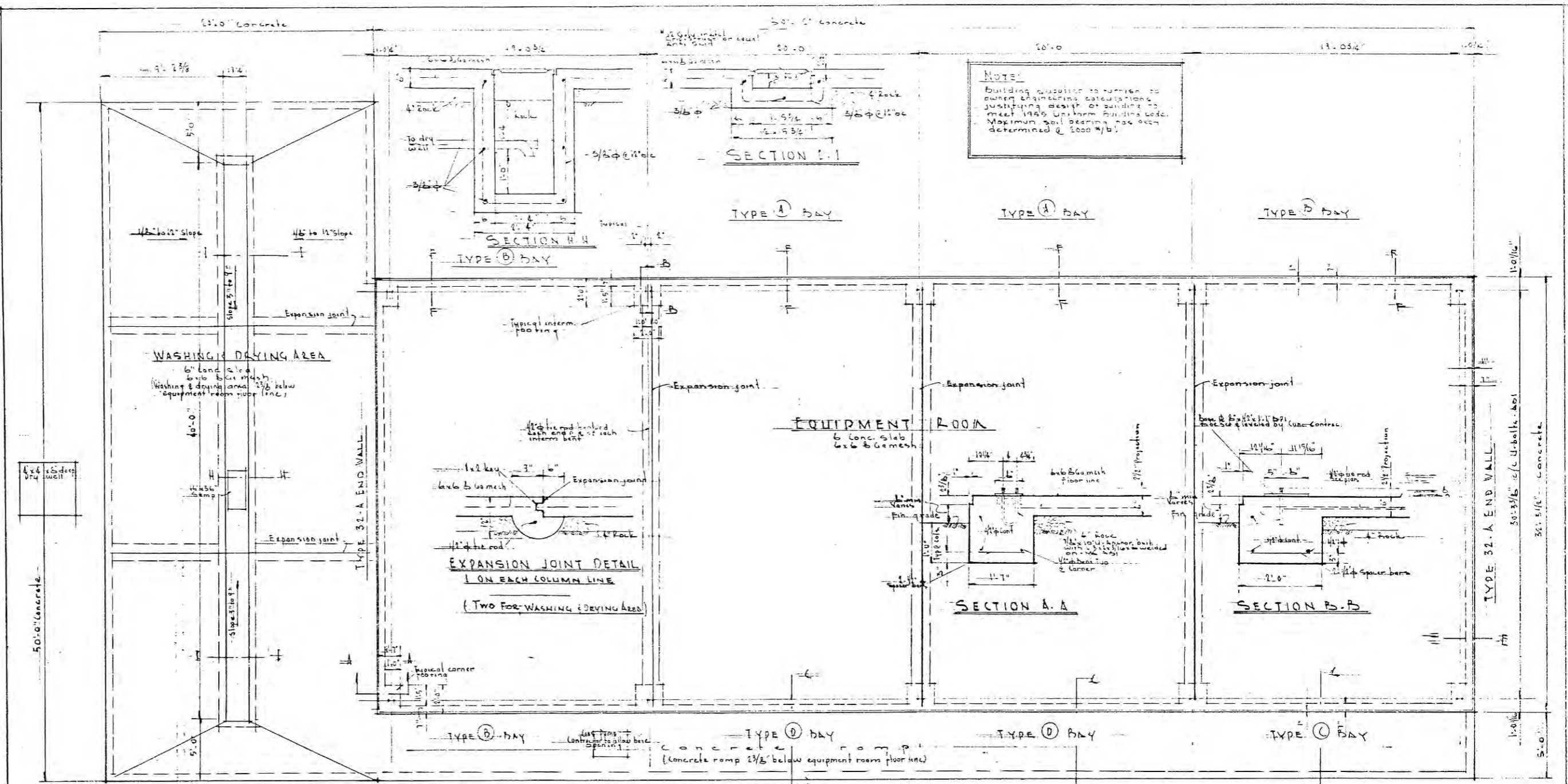

APPROVED BY	DESCADERO STATION	DATE
DESIGNED BY	EQUIPMENT STORAGE	1-11-61
CHECKED BY	BUILT	
CONTRACT NO.		
PROJECT NO.		
CLIENT NAME	SAN MATEO COUNTY	
CLIENT ADDRESS	DEPARTMENT OF	
CLIENT PHONE		

WASHINGTON & MITCHELL
 CIVIL AND STRUCTURAL ENGINEERS
 493 SANSOME ST., SAN FRANCISCO 14

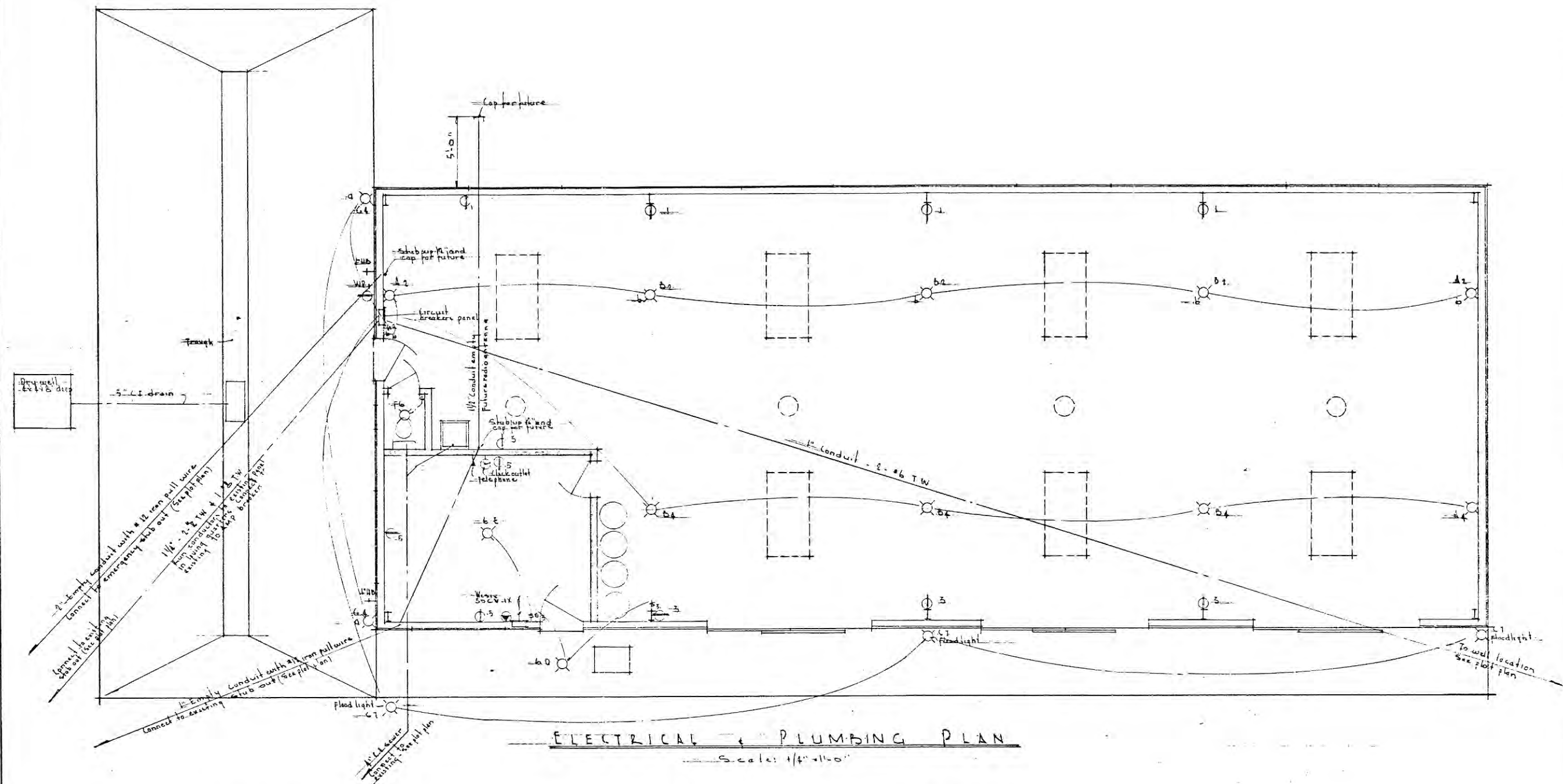

ELECTRICAL FIXTURE SCHEDULE

- A Benjamin #4526 with 200 watt lamp
- B Benjamin #5824 with #N-3585 Klipsch and 200 watt lamp
- C 3. Sheberlite & fittings each fixture S-300 with 2 R-40 lamps
- D R & S #6362 shallow dome vaporlight with 100 watt lamp
- E All-Data #28296 with 2-96-T-11-650 MA lamps
- F 3/4" pure Krypton socket
- G 2. Sheberlite & fittings each fixture S-300 with 2 R-40 lamps

PANEL SCHEDULE

- C10 1. South wall receptacles 20 A
- " 2. Overhead lights 15 A
- " 3. North wall receptacles 20 A
- " 4. Overhead lights & Estt floods 15 A
- " 5. Office receptacles 10 A
- " 6. Office 150 lights 15 A
- " 7. North floods 15 A
- " 8. Spare 10 A
- " 9. 2. Pole 230 volt well pumps 55 A
- " 10. 2. Pole 230 volt air comp. 15 A
- " 11. 200 volt 3 KW elect heater 20 A

SYMBOLS

- Outlet well or ceiling
- Duplex convenience outlet
- 200 V
- Close outlet to vent
- ⊙ Telephone
- Under slab

APPROVED BY	RESIDERO E. E. STATION	DATE
FILE NUMBER	EQUIPMENT STORAGE	NO. OF SHEETS
COUNTY MANAGER	SAN MATEO COUNTY	5 of 5
DATE	APPROVED BY	FILE NO.

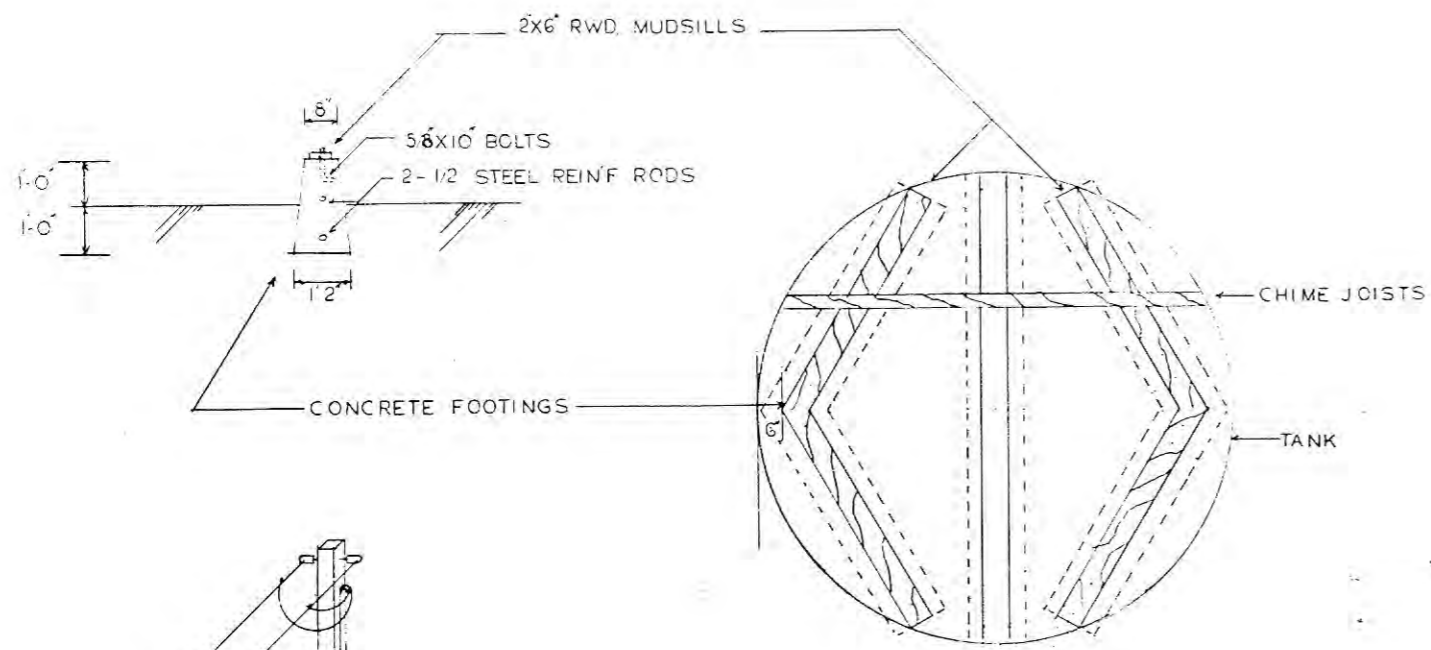

===== PIPING ABOVE GRADE
 ----- PIPING BELOW GRADE
 - - - - - CONDUIT BELOW GRADE
 - - - - - EXISTING CONDUIT

- 1-CONCRETE FOUNDATION FOR STORAGE TANK BY OTHERS
- 2-PUMPING STRUCTURE AND CONCRETE FLOOR BY OTHERS
- 3-ALL PIPING BELOW GRADE SHALL BE INSTALLED AT A DEPTH OF 1'-0" MIN.

FOUNDATION PLAN FOR STORAGE TANK

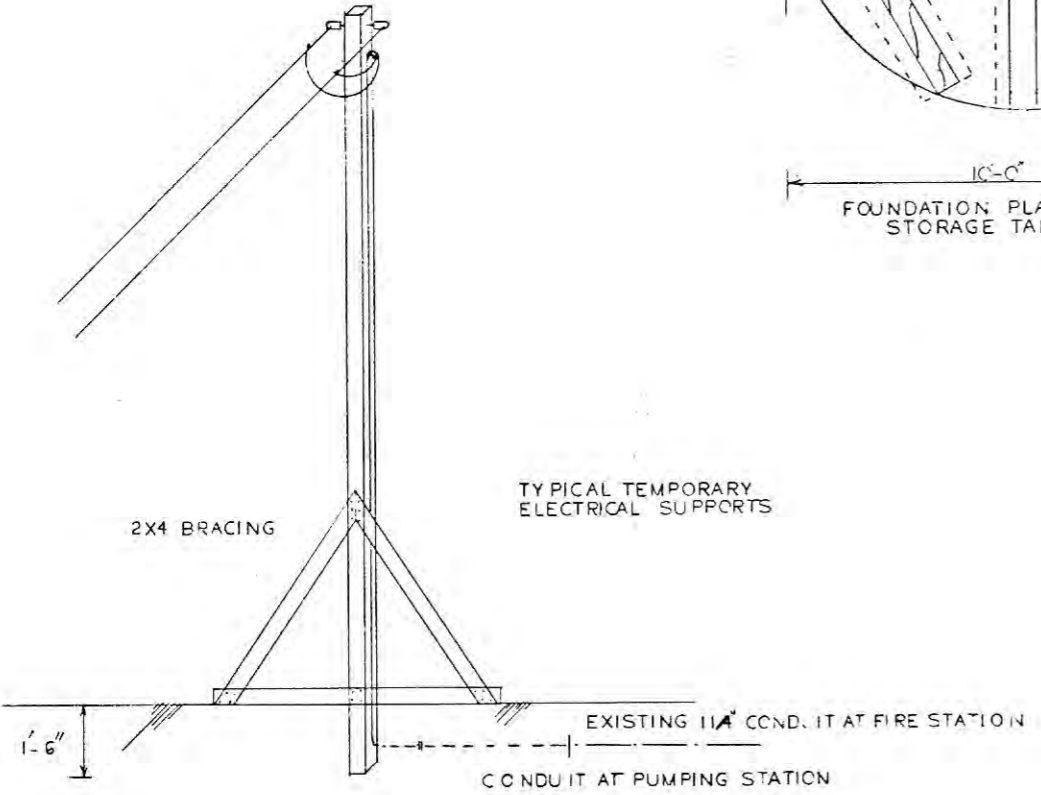

TYPICAL TEMPORARY ELECTRICAL SUPPORTS

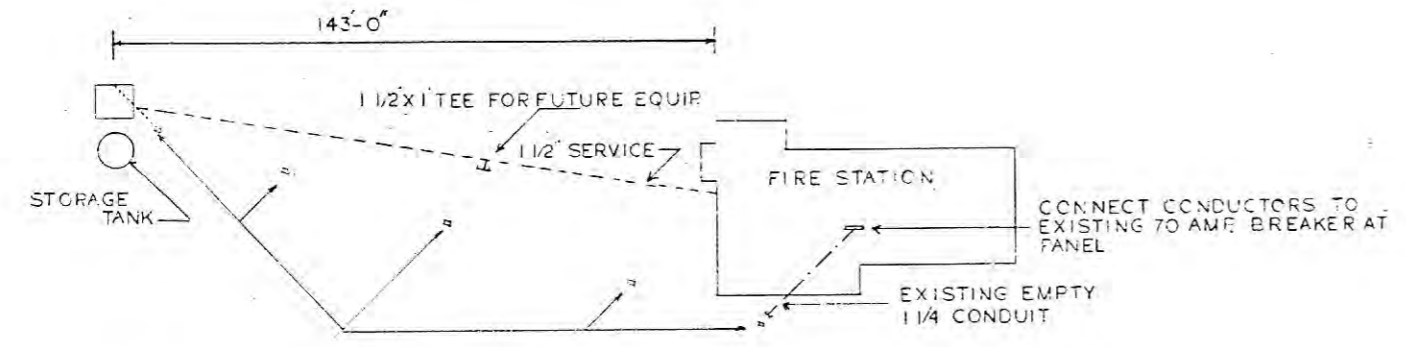

TEMPORARY ELECTRICAL SUPPORTS
PLOT PLAN
NO SCALE

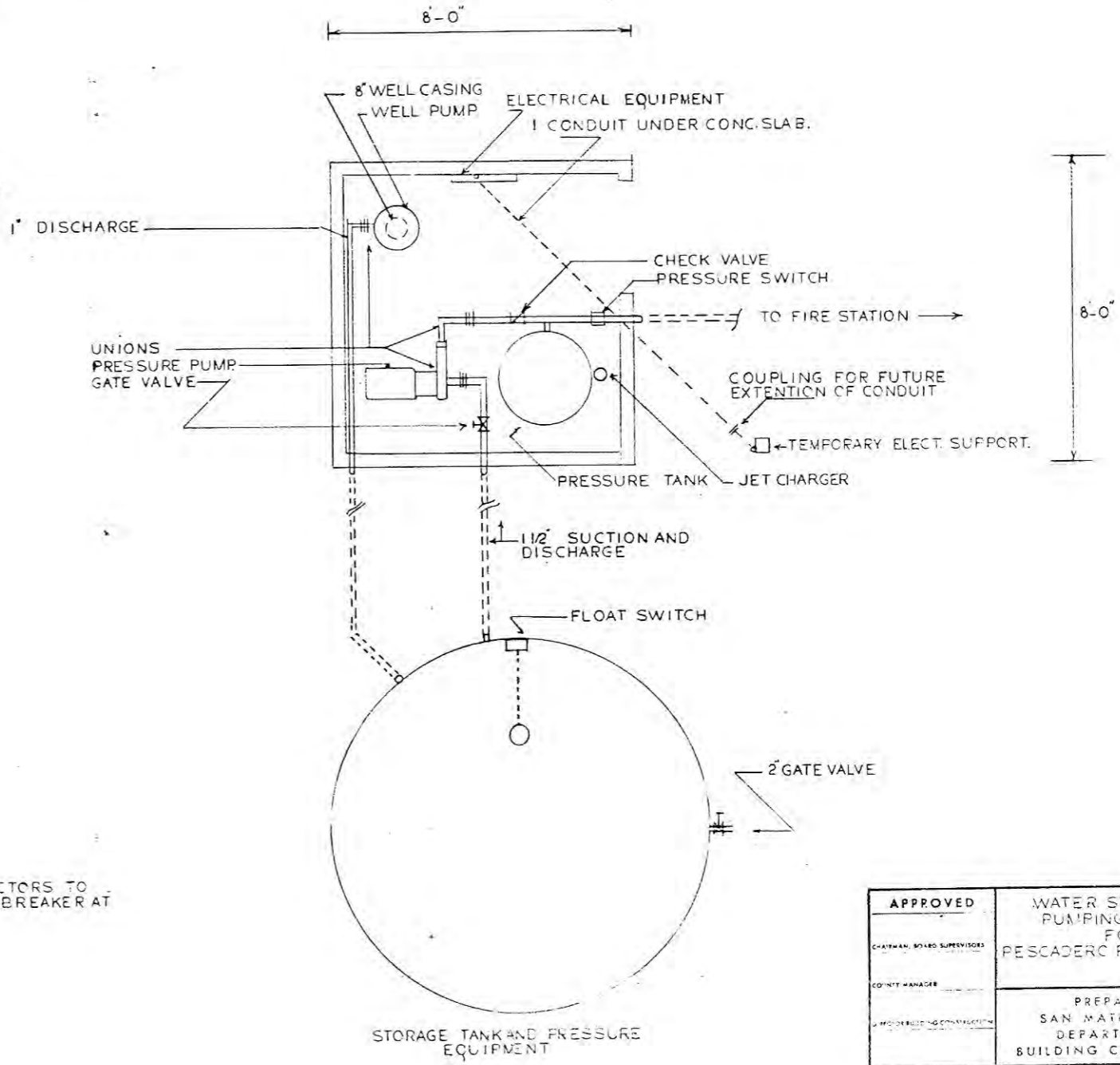

STORAGE TANK AND PRESSURE EQUIPMENT

APPROVED	WATER STORAGE AND PUMPING SYSTEM FOR PESCADERO FIRE STATION	DATE 6-28-57
CHAIRMAN, BOARD SUPERVISORS		1:2=10'
COUNTY MANAGER		J.C.P.
ENGINEER IN CHARGE	PREPARED BY SAN MATEO COUNTY DEPARTMENT OF BUILDING CONSTRUCTION	

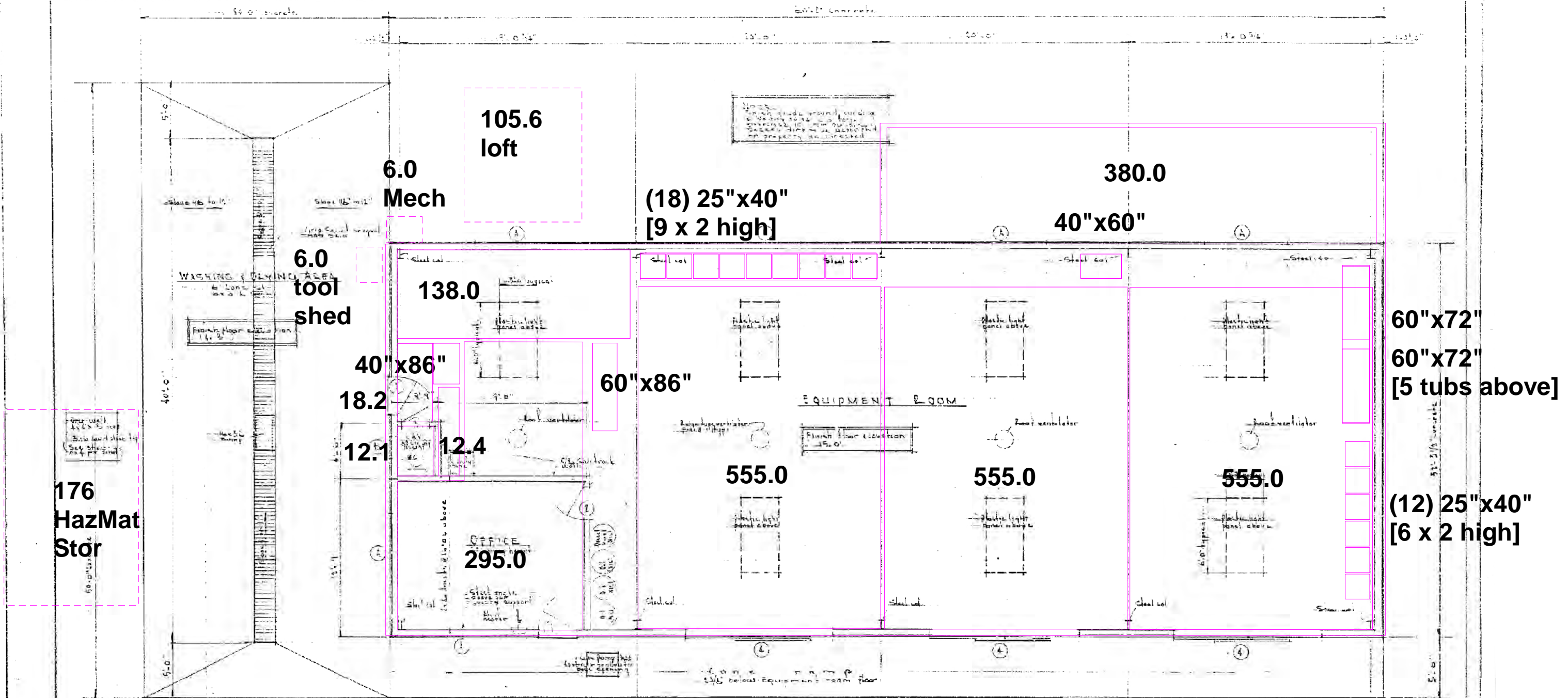

FLOOR PLAN 3023 Main level
 105 Loft
 3128 GSF

SCHEDULE OF ROOM FINISHES						
ROOM	FLOOR	BASE	WALLS	CEILING	CEILING	PAINTING
EQUIPMENT	CONCRETE	CONCRETE	CONCRETE	CONCRETE	CONCRETE	CONCRETE
OFFICE	CONCRETE	CONCRETE	CONCRETE	CONCRETE	CONCRETE	CONCRETE
LAV	CONCRETE	CONCRETE	CONCRETE	CONCRETE	CONCRETE	CONCRETE

NOTES:
 1. EXCEPT WHERE SHOWN OTHERWISE, ALL FINISHES SHALL BE AS SHOWN ON THIS SCHEDULE.
 2. FINISHES SHALL BE AS SHOWN ON THIS SCHEDULE UNLESS OTHERWISE NOTED.
 3. FINISHES SHALL BE AS SHOWN ON THIS SCHEDULE UNLESS OTHERWISE NOTED.

WINDOW SCHEDULE			
NO	SIZE	TYPE	NOTE
1	4'0" x 6'0"	DOUBLE GLAZED	SEE PLAN
2	4'0" x 6'0"	DOUBLE GLAZED	SEE PLAN

DOOR SCHEDULE			
NO	SIZE	TYPE	NOTE
1	3'0" x 7'0"	SLIP STREAM	SEE PLAN
2	3'0" x 7'0"	SLIP STREAM	SEE PLAN
3	3'0" x 7'0"	SLIP STREAM	SEE PLAN
4	3'0" x 7'0"	SLIP STREAM	SEE PLAN

160 storage container
 80 storage shed

APPROVED BY: _____
 DATE: _____
 PROJECT: PESCADERO FIRE STATION
 DRAWING: EQUIPMENT STORAGE

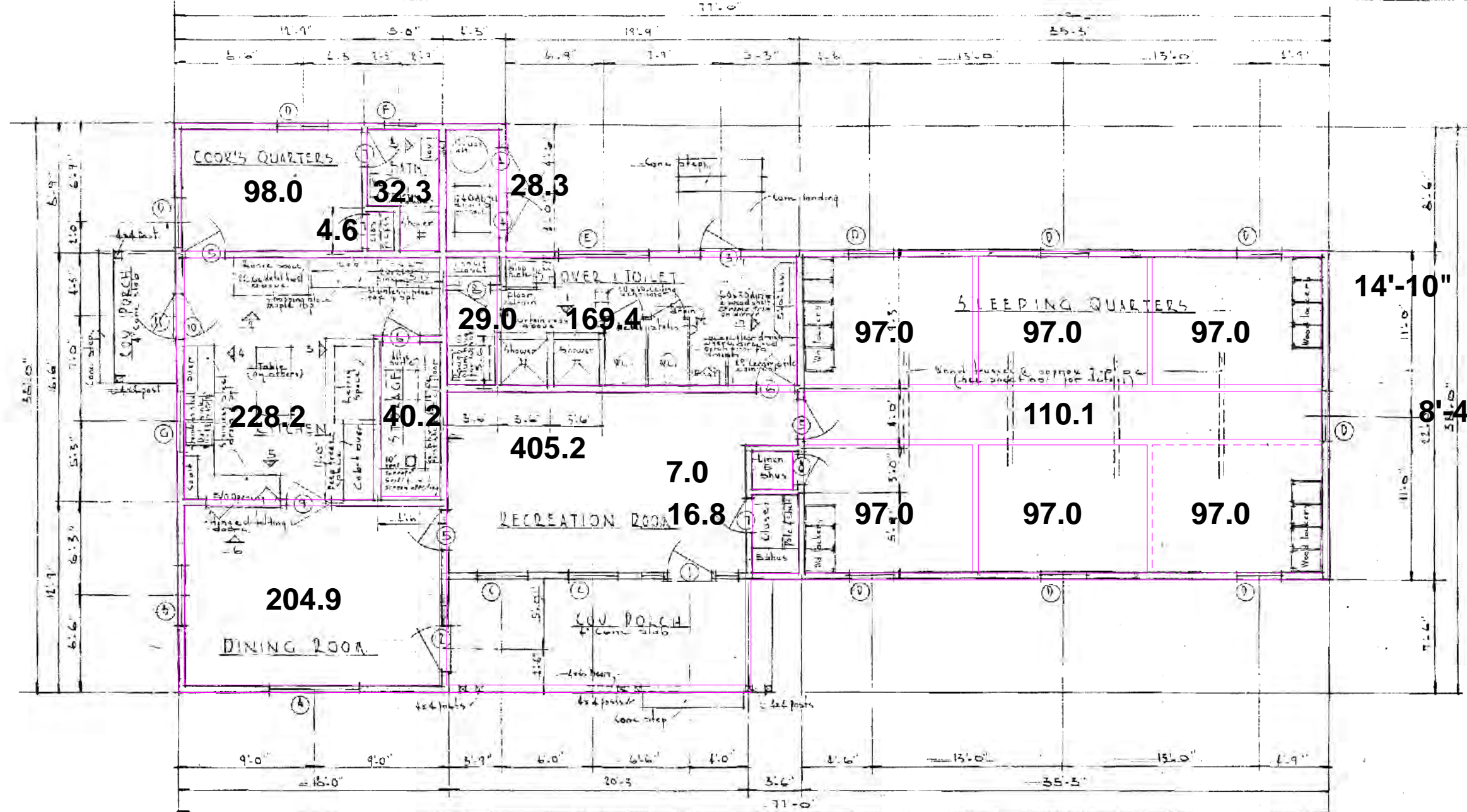

FLOOR PLAN 2175 GSF
 Section as 3 for truss detail

SCHEDULE OF ROOM FINISHES						
ROOM	FLOOR	BASE	WALLS	TRIM	CEILING	PAINTING SPECIFICATIONS
SLEEPING QUARTERS	Asphalt tile	Rubber base	Sheetrock painted	Wood	popcorn ceiling Expanded metal painted	Spec # 1 & 2
DINING	(Ceramic floor)	"	"	"	Sheetrock painted	" # 1 & 2
COOK'S QUARTERS	"	"	"	"	"	" # 1 & 2
KITCHEN	(Ceramic floor)	"	"	"	"	" # 2 & 3
BATH	"	"	"	"	"	" # 2 & 3
SHOWERS TOILET	Ceramic tile on concrete	Ceramic tile on concrete	Ceramic tile Sheetrock painted	"	"	" # 2 & 3
STORAGE	Asphalt tile	Rubber base	Sheetrock painted	"	"	" # 1 & 2
CLOSET	"	"	"	"	"	" # 1 & 2
RECREATION	"	"	"	"	"	" # 1 & 2
FURNACE	1" on slab	None	5/8" Sheetrock on concrete	"	5/8" Sheetrock on concrete	" # 2

PAINTING NOTES:
 Interior woodwork shall be specification #2 except ceiling of Sleeping Room which shall be #1
 Interior walls & ceilings shall be specification #1 except in Kitchen, Bath & Toilets which shall be #3
 Exterior woodwork shall be specification #4
 Exterior metal shall be specification #4

WINDOW SCHEDULE			
NO	SIZE	TYPE	NOTES
A	4'-0" x 4'-2 1/2"	Alum. casement	All glass shall be "B" Quality type Double Strength
B	4'-0" x 4'-2 1/2"	"	
C	5'-0" x 4'-2 1/2"	"	
D	5'-0" x 2'-0"	"	
E	6'-0" x 5'-2 1/2"	"	1" minimum thickness 8222 (1/2" x 1/2" x 1/2")
F	5'-0" x 2'-0"	"	Opaque glass
G	4'-0" x 3'-2 1/2"	"	

Furnish one screen for each venetian window

DOOR SCHEDULE			
NO	SIZE	TYPE	NOTES
1	5'-0" x 6'-6" 1 1/2"	DF 9116	made in USA
2	5'-0" x 6'-6" 1 1/2"	DF	Furnish 4 lock
3	7'-6" x 6'-6" 1 1/2"	DF transposed	
4	5'-0" x 6'-6" 1 1/2"	DF	Furnish 4 lock
5	6'-0" x 6'-6" 1 1/2"	DF	" 4 lock
6	7'-6" x 6'-6" 1 1/2"	DF	" "
7	2'-4" x 6'-6" 1 1/2"	DF	" "
8	2'-0" x 6'-6" 1 1/2"	DF	" "
9	5'-0" x 6'-6" 1 1/2"	DF double entry	" 4 lock
10	5'-0" x 6'-6" 1 1/2"	DF 1 1/2"	" 4 lock
11	5'-0" x 6'-6" 1 1/2"	DF 1 1/2"	" 4 lock

Approved by: _____
 Prepared by: _____
 Checked by: _____
 Date: _____

LIVING QUARTERS
COV PORCH
RECREATION ROOM
COOK'S QUARTERS
BATH
TOILET
SLEEPING QUARTERS
DINING ROOM
KITCHEN
STORAGE
CLOSET
FURNACE

The 2010 Forest and Range Assessment: Final Document

http://frap.fire.ca.gov/data/assessment2010/pdfs/california_forest_assessment_nov22.pdf

This assessment highlights key issues, resource status and trends and priority landscapes for the subsequent strategy document, which will provide a framework for state and federal programs to support good forest and rangeland stewardship in California.

Chapter 3.7 Climate Change: Threats and Opportunities. A variable pattern of annual precipitation is expected; increasing through 2069, then followed by a large decrease by 2099.

California Coastal Commission Draft Sea-Level Rise Policy Guidance. Public Review Draft.

http://www.coastal.ca.gov/climate/slr/guidance/CCC_Draft_SLR_Guidance_PR_10142013.pdf

Page 5 of the document, showing projected sea level rise, is included below.

California Coastal Commission Draft Sea-Level Rise Policy Guidance
Public Review Draft, October 14, 2013

Table 1. NRC Sea-Level Rise Projections for California (NRC, 2012)

TIME PERIOD	NORTH OF CAPE MENDOCINO	SOUTH OF CAPE MENDOCINO
2000 – 2030	-4 – +23 cm (-1.56 – 9 inches)	4 – 30 cm (1.56 – 11.76 inches)
2000 – 2050	-3 – + 48 cm (-1.2 – 18.84 inches)	12 – 61 cm (4.68 – 24 inches)
2000 – 2100	10 – 143 cm (3.6 – 56.28 inches)	42 – 167 cm (16.56 – 65.76 inches)

Could be 24” rise within 50-year lifespan of New Fire Station

In addition to these sea-level rise projections, the 2012 NRC report provides information on the impacts of sea-level rise in California. According to the report, sea-level rise will cause flooding and inundation, an increase in coastal erosion, changes in sediment supply and movement, and saltwater intrusion to varying degrees along the California coast. These effects in turn could have a significant impact on the coastal economy and could put important coastal resources and coastal development at risk, including ports, marine terminals, commercial fishing infrastructure, public access, recreation, wetlands and other coastal habitats, water quality, biological productivity in coastal waters, coastal agriculture, and archeological and paleontological resources.

PRINCIPLES FOR ADDRESSING SEA-LEVEL RISE IN THE COASTAL ZONE

This guidance is rooted in certain fundamental guiding principles, many of which derive directly from the requirements of the Coastal Act. In this respect, the principles are not new, but rather generally reflect the policies and practices of the Commission since its inception in addressing coastal hazards and the other resource and development policies of the Act. Each of the four groups of principles below embodies important concepts that are specifically and increasingly raised by the challenges of rising sea levels. This guidance builds on the cumulative knowledge and experience of the agency to help identify practical guidance for addressing sea-level rise in the California coastal zone, consistent with these principles and the statewide policies of the California Coastal Act.

A. Use Science to Guide Decisions [Coastal Act Sections 30006.5; 30335.5]

1. Acknowledge and address sea-level rise as necessary in planning and permitting decisions.
2. Use the best available science to determine locally relevant (context-specific) sea-level rise projections for all stages of planning, project design, and permitting reviews.
3. Recognize scientific uncertainty by using scenario planning and adaptive management techniques.

B. Minimize Coastal Hazards through Planning and Development Standards [Coastal Act Sections 30253, 30235; 30001, 30001.5]

4. Avoid significant coastal hazard risks where feasible.
5. Minimize hazard risks to new development over the life of authorized structures.