

**SAN MATEO COUNTY  
DISTRICT ATTORNEY'S OFFICE**



**BUREAU OF INVESTIGATION**

<b>NAME:</b>	Chinedu Okobi (Decedent)	<b>DATE:</b>	October 3, 2018
<b>INSPECTOR:</b>	Jamie Draper	<b>CASE#</b>	DAI 18-1003-02
<b>CASE TYPE:</b>	Officer Involved Critical Incident: In-Custody Death Investigation – San Mateo County Sheriff's Office		SMCSO 18-9733

---

**Master Summary Report**

**SUMMARY**

On October 3, 2018 at approximately 1:00 PM, San Mateo County Sheriff's Office Deputy Joshua Wang attempted to conduct a pedestrian stop of a subject ultimately identified as Decedent Chinedu Okobi in the 1400 block of El Camino Real in the City of Millbrae. Deputy Wang first observed Decedent Okobi walking eastbound across the lanes of southbound and northbound traffic on El Camino Real in violation of California Vehicle Code section 21955. Deputy Wang attempted to initiate contact with Decedent Okobi on the east side of El Camino Real; however, Decedent Okobi went back westbound across traffic disregarding Deputy Wang's verbal commands to stop. Deputy Wang made several U-turns on El Camino Real attempting to contact Decedent Okobi as he went back and forth across the lanes of traffic and ran north in the middle of the roadway. Deputy Wang requested additional deputies to respond to his location to assist in detaining Decedent Okobi.

Deputy Alyssa Lorenzatti and Deputy John DeMartini arrived in the area and attempted to contact Decedent Okobi as he was walking southbound on the sidewalk along the west side of El Camino Real. Deputy Lorenzatti tried to grab Decedent Okobi's left hand; however, Decedent Okobi pulled his hand away from Deputy Lorenzatti. Deputy DeMartini also attempted to grab Decedent Okobi's arm, grasping Okobi's long sleeved shirt. Decedent Okobi pulled away from Deputy DeMartini and was able to pull himself out of the shirt and Deputy DeMartini's grasp. Decedent Okobi turned to flee from the deputies, then changed his path of travel and advanced toward Deputy Wang. Deputy Wang drew his Taser and issued a warning to Decedent Okobi to comply or the Taser would be used. Deputy Wang activated his Taser at Decedent Okobi as Okobi

appeared to reach out in either a grabbing or swatting motion toward Deputy Wang's Taser which resulted in the two (2) probes of the Taser striking Decedent Okobi in the back of the right hand or forearm and the right side of his upper torso/chest. Chinedu Okobi then fell to the ground during the five (5) second activation period of the Taser. Deputy Bryan Watt and Sergeant David Weidner arrived on the scene and attempted to assist Deputy Wang, Deputy Lorenzatti, and Deputy DeMartini in attempting to get Decedent Okobi to comply with verbal commands to roll over on his stomach so Okobi could be handcuffed. The involved deputies made several attempts to grab Decedent Okobi's arms and leg; however, Okobi was repeatedly able to pull away from them and kick at the involved deputies. Deputy Wang conducted a second, five (5) second activation of his Taser while Decedent Okobi was on the ground, actively resisting attempts by the deputies to gain compliance.

Decedent Okobi was able to get back on his feet and push Deputy DeMartini away from him. As Decedent Okobi attempted to walk away from the Deputies, Deputy Wang conducted a third, five (5) second activation of his Taser, which caused Okobi to fall back to the ground. Deputy Wang activated a fourth, ineffective attempt with his Taser as Decedent Okobi tried again to stand up. Decedent Okobi was able to stand and began to move eastbound and then southbound on El Camino Real in the lanes of traffic as Deputy Wang made two (2) additional, ineffective attempts to deploy his Taser. Deputy Wang drew his ASP (collapsible baton) and tried to strike Decedent Okobi with the ASP; however, Deputy Wang was then punched on the left side of his head at least one (1) time by Okobi. Decedent Okobi grabbed Deputy Wang around the waist and grasped Deputy Wang's holstered firearm when Deputy DeMartini was able to knock Decedent Okobi to the ground. Deputy Wang, Deputy Lorenzatti, Deputy Watt, Deputy DeMartini and Sergeant Weidner then struggled with Decedent Okobi on the ground for several minutes while attempting to get control of Okobi and place him in handcuffs. During the struggle on the ground, Deputy Wang deployed his pepper spray, which inadvertently struck Deputy Watt, Deputy Lorenzatti and Sergeant Weidner in the face and eyes.

The involved deputies were ultimately able to place two (2) sets of interlocked handcuffs on Decedent Okobi's wrists and get him under control. At Sergeant Weidner's direction, the involved deputies rolled Decedent Okobi to his side and ultimately to a seated position to avoid potential positional asphyxia. The deputies then summoned medical attention to the scene. Several minutes later, while being attended to by emergency medical personnel, Decedent Okobi went into cardiac arrest. Attempts were made by emergency medical personnel to revive Decedent Okobi who was transported Mills-Peninsula Hospital for additional medical treatment. Emergency medical staff at Mills-Peninsula Hospital were unable to revive Decedent Okobi. Portions of the incident were captured on Mobile Audio Video (MAV) cameras in the San Mateo County Sheriff's Office patrol vehicles as well as via a cellular phone video recorded by Witness Robert Garrison at the scene.

The San Mateo County Officer Involved Critical Incident Protocol was enacted.



**SCENE:**

The primary scene is in the northbound and southbound lanes of traffic for the 1400 block of El Camino Real in Millbrae. The initial scene is in the southbound lanes of traffic near the western curb line of El Camino Real while the secondary scene is in the center of the northbound lanes of traffic for El Camino Real.

Scene image taken by Menlo Fire Department via drone on October 3, 2018:



**SCENE SKETCH (Overhead, not to scale)**

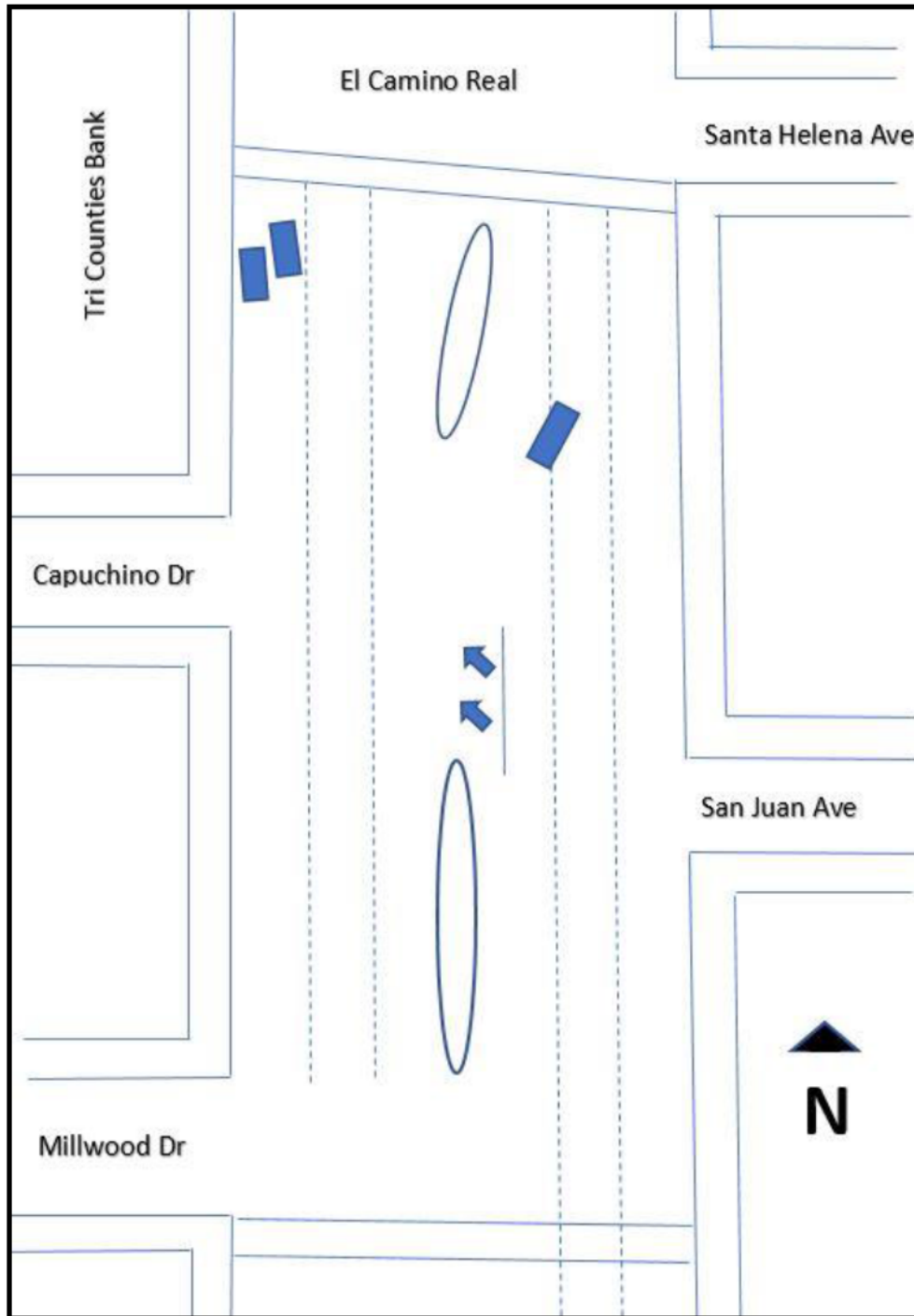

## **PERTINENT WITNESS STATEMENTS (Summarized herein):**

### **Statement of Witness: Robert Garrison**

Robert Garrison was interviewed at his residence on October 3, 2018 by Inspector Eric Suzuki. Garrison stated he was inside the Tri Counties Bank located at 1551 El Camino Real, Millbrae where he was at the teller stand. Garrison said he heard some of the bank tellers start to yell. Garrison said he turned around and saw two (2) police vehicles arrive and saw a subject determined to be Decedent Okobi. Garrison described Decedent Okobi as being “very large, 6 feet or taller, heavy build, African American, weight maybe 270”. Garrison described Decedent Okobi as looking “really crazy” and “was just going around like he was going to fight somebody”. Garrison said it appeared to him that Decedent Okobi was running away from the officers and had removed his sweater “like he was getting ready to fight or flee”. Garrison said he took out his cellular phone and recorded the activity after seeing that Okobi had been “tased” by what he described as a “tall, Asian-American officer” (Deputy Joshua Wang). Garrison recorded a total of six (6) short video clips of the incident, which he voluntarily provided to Inspector Suzuki.

Garrison stated he saw Decedent Okobi on the ground “squirming around a little bit, still resisting and had his hands up”. Garrison said the deputies tried to approach Decedent Okobi to “maybe arrest him” but Okobi was moving around a lot. Garrison believed he saw Decedent Okobi rip the Taser wires off and saw Okobi get back on his feet again before being “tased” a second time. Prior to being “tased” the second time, Garrison said Decedent Okobi swung at one of the deputies and knocked the deputy’s glasses off. Garrison described the deputy as “a short, Caucasian officer” (Deputy John DeMartini). Garrison said Decedent Okobi fell to the ground after being “tased” the second time and was behind a police vehicle, so Garrison was unable to see what was occurring. Garrison moved to a better vantage point and was able to see Decedent Okobi get back up and said Okobi began to run east toward the northbound lanes of El Camino Real. Garrison said there was a portion which occurred in between his video segments in which he saw Decedent Okobi drag Deputy Wang to the ground. Garrison described Decedent Okobi as “resisting and assaulting the officer” and said this occurred between two (2) segments of video he recorded. Garrison said the first segment showed Decedent Okobi punch Deputy Wang in the face. Garrison said the next video segment then showed Decedent Okobi already being subdued on the ground. Garrison described the struggle on the ground between the deputies and Decedent Okobi as lasting an estimated five (5) to ten (10) minutes before Okobi was subdued and handcuffed. Garrison recalled seeing Decedent Okobi in a seated position after being handcuffed and noted Okobi “looked like he was conscious for sure”. Garrison said Decedent Okobi was being loaded onto a gurney when he left the area.

Garrison did state he observed a stocky, bald Caucasian deputy (Deputy Bryan Watt) use a baton during the incident. Garrison believed Deputy Watt struck Decedent Okobi once with the baton, but it appeared to his as though Okobi did not feel anything.



**Statement of Witness: Farida Khalid**

In accordance with the Officer-Involved Critical Incident (OICI) Protocol, Detective Jeremy Ordone of the Menlo Park Police Department responded to assist with the interviewing of witnesses in this investigation. Detective Ordone interviewed Farida Khalid on October 3, 2018 at the Tri Counties Bank, 1551 El Camino Real, Millbrae.

Khalid, an employee of the bank, was behind her teller desk when she observed a black male who she estimated was approximately six (6) feet tall (Decedent Chinedu Okobi) walking toward the bank on El Camino Real. Khalid observed four (4) or five (5) Sheriff's Deputies following Decedent Okobi. Khalid saw one of the deputies utilize a Taser on Decedent Okobi and said Okobi appeared to not comply and continued to resist. Khalid saw Decedent Okobi move away from the bank and saw Okobi be surrounded by the involved deputies near a "No U-Turn" sign in the middle of El Camino Real. Khalid said even though he was surrounded, Decedent Okobi continued to push the deputies. Khalid said she did not see when Decedent Okobi was eventually taken into custody or what happened afterward as she had returned to her work.

**Statement of Witness: Gia Ferrera**

Detective Ordone interviewed Gia Ferrer at the Offices of Dr. Ankur Parikh, DDS located at 1490 El Camino Real, Millbrae. Ferrer, an employee of the dental offices, was at her desk facing El Camino Real when she observed lights from police vehicles across El Camino Real near the Tri Counties Bank. Ferrer observed a male subject running from Sheriff's Deputies. Ferrer described the subject as approximately 5'10" to 6'0" tall and approximately 350 pounds wearing a blue shirt and dark pants (Decedent Okobi). Ferrer saw approximately six (6) deputies attempting to contact Decedent Okobi and described Okobi as resisting arrest and wandering in and out of traffic. Ferrer observed one (1) deputy deploy his Taser at Okobi and described seeing the Taser wires on Decedent Okobi after the use of the device. Ferrer said Decedent Okobi fell and stayed on the ground for approximately thirty (30) seconds before getting back to his feet. Ferrer heard several different deputies yell "stop" an estimated twelve (12) times beginning when Decedent Okobi was running until after the deployment of the Taser. Ferrer said she could hear Decedent Okobi say "No, no, no" throughout the entire incident.

Ferrer said Decedent Okobi ran into traffic on the north side of El Camino Real and described on-coming traffic as having to stop with the involved deputies having to hold their hands up to signal the drivers of the vehicles to stop. Ferrer said she observed one (1) deputy strike Decedent Okobi around the area of his stomach with a baton; however, Decedent Okobi appeared to not be phased by the strike. Ferrer described herself as being shocked Okobi did not go down from the baton strike and being surprised by how much energy Okobi had. Ferrer said one (1) of the deputies wrapped decedent Okobi in a "hug" which caused them both to fall to the ground. Ferrer said one (1) of the deputies struck his own head on the ground during the fall. Ferrer described the other



involved deputies as coming over to assist in detaining Decedent Okobi and said the deputies appeared to be struggling and having a hard time in trying to detain Okobi. Ferrer had a difficult time seeing all the activity once the involved deputies were on top of Decedent Okobi but described seeing Decedent Okobi on both his stomach and back at various times during the struggle and seeing Okobi attempting to get up. Ferrer described Decedent Okobi as continuing to fight, resist and making attempts to get up while the deputies attempted to hold Okobi down. Ferrer did not see Decedent Okobi being handcuffed and next recalled paramedics having arrived on the scene and conducting CPR on Okobi. Ferrer described approximately 25 to 30 minutes elapsing between the beginning of the incident to the time when the ambulance left the scene.

**Statement of Witness: Dennis Barboza**

In accordance with the Officer-Involved Critical Incident (OICI) Protocol Detective Josh Russell of the Menlo Park Police Department responded to assist with the interviewing of witnesses in this investigation. Detective Russell interviewed Dennis Barboza on October 3, 2018 at his business (Sun Trezz Tanning Salon) located at 1486 El Camino Real, Millbrae.

Barboza said he was behind the front desk at his business when he heard a police siren. Barboza said he looked outside and saw a black male out on the street corner (Decedent Okobi). Barboza said he heard a second siren and got up from his seat to looked outside, where he saw Decedent Okobi carrying two (2) backpacks walking southbound on the west side walk for El Camino Real. Barboza described Decedent Okobi as a “big guy” and said Okobi was “mumbling”. Barboza described Decedent Okobi as walking toward two (2) deputies who were smaller in stature, appearing as if he was going to move the two (2) deputies out of his way. Barboza saw Decedent Okobi had removed his backpack and raised his hands when deputies deployed a Taser at him. Barboza said Decedent Okobi fell forward and was on the ground “mumbling” with his arms outstretched. Barboza said the involved deputies approached Decedent Okobi and told him several times to get on his stomach. Barboza said Decedent Okobi got back up and may have been subjected to the Taser again as he fell back to the ground. Barboza said Decedent Okobi got up again and began “loping” across the center median of El Camino Real toward Barboza’s business. Barboza was able to see Decedent Okobi’s face and said he though Okobi looked like he was either “high” or mentally handicapped.

Barboza said the involved deputies began to “grapple” with Decedent Okobi and he recalled seeing an Asian deputy (Deputy Joshua Wang) and Okobi both fall to the ground. Barboza said five (5) deputies were on top of Decedent Okobi on the ground and he recalled seeing one (1) deputy take out “mace” and sprayed Okobi with it. Barboza said he heard one (1) of the other deputies get up from the group and state he could not see. Barboza said he could see Deputy Joshua Wang had a cut near his eye and could hear a deputy say “give me your hands” several times and heard a deputy say “give me your handcuffs”. Barboza recalled seeing Decedent Okobi sitting upright, leaning against the legs of a deputy. Barboza described Decedent Okobi as drooling and having his head

down toward his chest. Barboza described paramedics as having arrived and administering CPR to Decedent Okobi.

**Statement of Witness: Kirankumar Patel**

Detective Russell interviewed Kirankumar Patel on October 3, 2018 at the Days Inn located at 1550 El Camino Real, Millbrae. Patel, a desk manager for the Day's Inn said he was out front of the hotel when he observed a man (Decedent Okobi) crossing the busy El Camino Real. Patel said a deputy attempted to stop Decedent Okobi, but Okobi did not stop. Patel described the deputy as attempting to stop Decedent Okobi from entering the roadway and said one (1) deputy alone could not handle Decedent Okobi so more deputies arrived. Patel described Decedent Okobi as appearing to be in the mood to fight and waving his hands. Patel said one (1) of the deputies "shot" something and Decedent Okobi fell to the ground and seemed to Patel to be unconscious. Patel said Decedent Okobi got up and was moving around again as other deputies arrived on scene. Patel said Decedent Okobi appeared to still be uncooperative. Patel said the involved deputies were able to surround Decedent Okobi and said he did not know what the deputies did but noted Okobi again appeared to him to be unconscious. Patel said Decedent Okobi was repeatedly saying "no" and the deputies were repeatedly saying "stop" during the incident.

Patel allowed Detective Russell to review the hotel's video surveillance footage, which captured a limited view of the attempts by Deputy Wang to conduct a pedestrian stop of Decedent Okobi. Detective Russell obtained a copy of the video footage.

**Statement of Witness: Nicole Basurto**

On October 5, 2018 Senior Inspector Bill Massey conducted an interview via telephone with witness Nicole Basurto. Basurto stated her belief that media reports which stated Decedent Chinedu Okobi died were incorrect. Basurto stated she was "fairly certain that he died on the scene." Basurto said that after Decedent Okobi was "brought to the ground, police officers tried to sit him up and he was unresponsive." Basurto said she could see that the subject was "unconscious" and she could recall Sheriff's Deputies leaving Decedent Okobi in a "sitting position, against the legs of an officer." Basurto said Decedent Okobi's body was "completely limp" at that time.

Nicole Basurto said her belief the Decedent Okobi was unconscious but wasn't certain if Okobi's heart had stopped or if it was about to. Basurto stated a man, whom she believed may have been the owner of the tanning salon nearby brought the deputies a bottle or bottles of water and the deputies splashed Decedent Okobi in the face with water and Okobi did not respond. Basurto said a few minutes passed and paramedics then arrived. Basurto said that she went back into her office located at Millbrae Dental, 88 Capuchino Drive in Millbrae, CA. Basurto stated watched from the windows of her office. Basurto said once paramedics arrived, they started checking Decedent

Okobi for a pulse. Basurto said her co-worker told her paramedics ripped open Decedent Okobi's shirt which she knew meant they are going to initiate CPR.

Basurto said that she ran back out to the street and saw paramedics had started compressions. Basurto said she knew paramedic would not start compressions unless a person is not breathing so she believed Decedent Okobi had "died already". Basurto said she never saw any of the Sheriff's Deputy initiate CPR prior to the arrival of paramedics and did not know if the deputies ever checked Decedent Okobi for a pulse. Basurto said she felt Decedent Okobi's heart stopped either when he was brought to the ground or right before that and felt the deputies should have started CPR sooner.

Nicole Basurto stated she was arriving back to work after lunch. she stated. Basurto said she was headed north on El Camino Real, towards Capuchino Drive and her place of work located at Millbrae Dental Care, 88 Capuchino Drive. Basurto said she pulled up to the intersection of El Camino Real and Capuchino Drive and was unable to make the left hand turn onto Capuchino Drive due to on-coming traffic. Basurto stated she began to watch the incident and saw approximately five to six deputies who were "kind of trying to talk to him." Basurto said she could not hear the exchange of words but she could see the body language. Basurto said Decedent Okobi looked "a little scared" Basurto was unsure if Decedent Okobi had a mental disability or not but said "I knew he wasn't totally there". Basurto stated the deputies "were trying to calm him down" and described Decedent Okobi as waving his hands in gestures she believed were due to Okobi not wanting to be touched. Basurto described Decedent Okobi as having voluntarily "got on the floor". Basurto thought it was odd the deputies did not try to arrest Decedent Okobi when he was on the ground and noted she thought Okobi may have been "on drugs" as he had rolled on his back and the deputies looked "puzzled". Basurto described this initial activity as having occurred in front of the Tri Counties Bank across from the ATM. Basurto estimated she was approximately fifty (50) feet from the location and watching from inside her vehicle.

Basurto recalled seeing Decedent Okobi struggling to get on his feet and was unsure if the deputies helped Okobi up or not. Once Decedent Okobi was successfully on his feet, Basurto said Okobi started backing away from the deputies and then turned to jog away from them. Basurto described Decedent Okobi as "a big heavyset man" and she could hear the deputies yelling for Okobi "stop, get on the floor, get on your stomach". Basurto said Decedent Okobi was not listening to the commands and kept running away from the deputies.

Basurto stated Decedent Okobi and the deputies went around the center median for El Camino and began moving in a direction toward where she was seated in her car. Basurto feared Decedent Okobi might try to get in her car, so she made a left hand turn onto Capuchino Drive. Basurto said she had her windows down when she turned and could hear the sound of a Taser "go off at least two (2) times". Basurto said she watched from her review mirror as a deputy (Deputy Joshua



Wang) had his “baton” out and started to hit Decedent Okobi in the back with the baton, swinging it “at least two, possibly three” times. Basurto said Decedent Okobi turned and started “swinging” at Deputy Wang with what she described as “slapping”. Basurto said Decedent Okobi made contact with Deputy Wang and they “got into a bit of a scuffle” which resulted in the other deputies arriving and taking Okobi to the ground. Basurto described Decedent Okobi as being “aggressive and violent and attacking one of the officers” when deputies brought Okobi to the ground. Basurto said she parked near the Tri Counties Bank, exited her vehicle and watched the activity further while on Capuchino Drive.

Basurto described seeing approximately six (6) to seven (7) deputies around Decedent Okobi when he was brought to the ground. Basurto described a male deputy as having hit Decedent Okobi three (3) to four (4) times with a closed fist. Basurto could not be certain where on Okobi’s body the hits were being directed but thought they “seemed to be his head”. Basurto felt these “hits” were unnecessary since Decedent Okobi was already being “pinned” to the ground. Basurto said she understood why deputies felt they needed to have so many deputies holding Decedent Okobi down since he as “a heavier set man, he was tall, he was a big guy” but she felt personally that there was no need to use so many deputies.

**Statement of Witness: Joseph Gonzales (Community Service Officer)**

Community Service Officer Joseph Gonzales with the San Mateo County Sheriff’s Office was interviewed by Senior Inspector Rich Maher on October 5, 2018 at the District Attorney’s Office.

Joseph Gonzales has been employed by the San Mateo County Sheriff’s Office as a Community Service Officer (CSO) for just over two (2) years. CSO Gonzales is assigned to the Millbrae Patrol Bureau working a 7:00 AM to 5:00 PM shift Monday through Wednesday. CSO Gonzales’ assigned duties include parking enforcement, traffic control, handling abandoned vehicles and the intake of property.

CSO Gonzales was on-duty and in full uniform on October 3, 2018 and was driving Sheriff’s Office vehicle #15, an unmarked Ford F150 pick-up truck. The truck is equipped with emergency lights to assist with traffic control. CSO Gonzales was wearing a light blue San Mateo County Sheriff’s Office shirt, navy blue color cargo style pants, a black duty belt and black boots. He confirmed that his uniform shirt has Sheriff’s Office shoulder patches, and a “Community Service Officer” badge and name tag on his chest.

CSO Gonzales said he heard an initial radio call from Deputy Wang requesting another officer and hearing Deputy Wang later ask for “Code-3”. CSO Gonzales said since the call originated as a “person running through traffic on El Camino” he responded from the Millbrae Substation to assist with any possible traffic control which might be required. CSO Gonzales said upon arrival, he could see Deputy Bryan Watt, Deputy Alyssa Lorenzatti, Deputy Joshua Wang and Sergeant David



Weidner in the southbound lanes of El Camino Real. CSO Gonzales activated his emergency lights and repositioned his vehicle at an angle to try and block the northbound lanes of El Camino Real.

CSO Gonzales remained in his vehicle as the group of deputies moved towards his location in pursuit of the man (Decedent Chinedu Okobi). CSO Gonzales said the deputies were yelling at Decedent Okobi to stop as they followed him over the center median. CSO Gonzales could not recall exactly what was being yelled by the deputies but said it was clear to him they were trying to get Decedent Okobi to stop. CSO Gonzales described Decedent Okobi as being a large black man, with scuff on his face, and wearing a blue shirt. CSO Gonzales estimated Decedent Okobi was over 6' tall and between 240 to 250 lbs.

CSO Gonzales looked to his right side briefly to check for traffic and looked back to see the deputies had tripped or fallen to the ground and were struggling with Decedent Okobi to the rear of his vehicle. CSO Gonzales exited his vehicle to help the deputies in their attempts to control Decedent Okobi. CSO Gonzales said he grabbed Decedent Okobi's right arm and hand to keep Okobi from striking the deputies. CSO Gonzales said he held Decedent Okobi's right arm securely to his own chest. CSO Gonzales said he could not recall exactly what was being said but did recall the involved deputies were telling Decedent Okobi to stop resisting and to put his hands behind his back. CSO Gonzales said he was not sure if pepper spray was deployed during the incident but did see several of the involved deputies backing away from the struggle to control Decedent Okobi and noted they appeared to be suffering from pepper spray exposure. CSO Gonzales said Deputy Watt was one (1) of the deputies who appeared to have been exposed to pepper spray. CSO Gonzales said Deputy Watt handed him a pair of handcuffs which he intended to use to assist in handcuffing Decedent Okobi, but the other deputies were successful in getting Okobi handcuffed without his help.

CSO Gonzales said once Decedent Okobi was handcuffed, the deputies sat Okobi up on his rear end. CSO Gonzales said he left to get water for the deputies effected by pepper spray but said when he left the immediate area, Decedent Okobi was conscious, awake, breathing, and looking around. CSO Gonzales said Decedent Okobi was sitting upright but appeared "out of it".

CSO Gonzales said medics were called to the scene and he thought they had been called because of the pepper spray exposure and because Deputy Wang had suffered a significant cut on his face. CSO Gonzales said Sergeant Weidner assigned him to stop traffic and redirect the passing vehicles. CSO Gonzales said he never realized there was anything wrong with Decedent Okobi. CSO Gonzales said he knew that when anyone is tased, medics are called to access them, so he didn't think there was anything significant about medics being present. CSO Gonzales said fire department personnel were "working" on Decedent Okobi (administering chest compression) as he was being transported to the ambulance but thought Okobi was alright once he had been placed on the ambulance.

CSO Gonzales said he did not see Decedent Okobi get tased but did see a taser prong and taser wires when he was restraining the man's hand and arm. CSO Gonzales thought the prong might have been in Decedent Okobi's right arm or the right side of Okobi's chest.

When asked why he got out of his vehicle, CSO Gonzales stated, "It was just a reaction. I saw that the team was struggling, um, I saw that they were not able to apprehend him, and I saw that his right hand was flailing." CSO Gonzales said he feared the deputies would not be able to establish control over Decedent Okobi. CSO Gonzales described Decedent Okobi as flailing his right arm and hand at Deputy Wang while Deputy Wang was grabbing Okobi around the body. CSO Gonzales said Deputy Wang was struck by Decedent Okobi with both open and closed hand strikes. CSO Gonzales said Decedent Okobi was "fighting" with five people and the five people were not able to stop Okobi. CSO Gonzales noted there were people out on the street watching and traffic was still moving; so, he didn't know what might happen if Decedent Okobi got up and continued down the street.

#### **STATEMENTS OF EMERGENCY MEDICAL PERSONNEL**

In accordance with the Officer-Involved Critical Incident (OICI) Protocol and the countywide San Mateo OICI Response Team, members of the Daly City Police Department interviewed the emergency medical personnel that responded to the 1400 block of El Camino Real on October 3, 2018. In response to the request by the involved deputies for emergency medical services to respond to the scene, Fire Engine #37 from the Central San Mateo County Fire Department, Fire Engine #51 of the San Bruno Fire Department, and American Medical Response (AMR) ambulances # 39 and 94 all responded to the scene to aid in the treatment of decedent Chinedu Okobi, Deputy Joshua Wang, Deputy Bryan Watt and Deputy Alyssa Lorenzatti.

Detective Joshua McQuade and Detective Brandon Scholes from the Daly City Police Department conducted interviews with a total of twelve (12) Firefighters, Paramedics and Emergency Medical Technicians (EMT) who were present at the scene and involved in the treatment of Decedent Okobi and the involved deputies. The following is a summary of interviews conducted by Detective McQuade and Detective Scholes:

#### **Statement of Fire Captain Thomas Donnelly:**

Detective Joshua McQuade conducted an interview with Thomas Donnelly on October 3, 2018. Captain Donnelly is a Fire Captain for the Central San Mateo County Fire Department and was part of the response to the scene on Engine #37. Captain Donnelly said he spoke with an unidentified Sheriff's Deputy (Sergeant David Weidner) who directed his attention toward a handcuffed subject (Decedent Okobi) and informed Captain Donnelly that Okobi had been tased twice during an altercation. Captain Donnelly said Decedent Okobi was in a seated, upright position being supported at the back by the legs of a Sheriff's Deputy. Sergeant Weidner informed

Captain Donnelly that three (3) Sheriff's Deputies had been exposed to pepper spray. Captain Donnelly said he requested another fire engine and a Battalion Chief to respond to the scene.

Captain Donnelly said he assigned one (1) of his firefighter-paramedics to attend to Decedent Okobi and the other firefighter paramedic to attend to two (2) Deputies who had been exposed to pepper spray. Captain Donnelly said one of the Sheriff's Deputies (Deputy Joshua Wang) appeared to have visible trauma on his face. Captain Donnelly said he did not observe any visible injuries on Decedent Okobi and assumed Okobi was breathing as his firefighter-paramedic assessed Okobi and did not notify him Okobi was in full arrest. Captain Donnelly said after the arrival of San Bruno Fire Department, Engine #51 he learned Decedent Okobi had gone into "full arrest". When Decedent Okobi went into full arrest, firefighter-paramedic Mark Mazza ceased providing medical treatment to Deputy Wang and assisted with attending to Decedent Okobi. Captain Donnelly said medical personnel continued to provide life saving measures on Decedent Okobi, placed him in an ambulance, and transported him to the hospital.

**Statement of Firefighter-Paramedic Mark Mazza:**

Detective Joshua McQuade conducted an interview with Mark Mazza on October 3, 2018. Mark Mazza is a firefighter-paramedic with the Central San Mateo County Fire Department and was part of the response to the scene on Engine #37. Firefighter Mazza said he was assigned by Captain Donnelly to attend to the injuries of Deputy Joshua Wang. Firefighter Mazza said he observed a subject in-custody (Decedent Okobi) who was seated upright on the pavement with one (1) or two (2) Sheriff's Deputies propping up Okobi's back. Firefighter Mazza said he was approximately fifteen (15) feet from Decedent Okobi and could see Okobi was moving, his abdomen was rising and falling as if Okobi was inhaling and exhaling.

Firefighter Mazza said Deputy Wang appeared to him to be "dazed" and had several lacerations to the left side of the face. Firefighter Mazza said Deputy Wang told him he had been hit in the face and had his face "grabbed" by Decedent Okobi. Firefighter Mazza said he applied a blood pressure cuff to Deputy Wang and went to retrieve sterile water from the fire engine to provide to the deputies who had been exposed to pepper spray. Firefighter Mazza said upon returning to Deputy Wang's location, a firefighter-paramedic attending to Decedent Okobi yelled to firefighter Mazza he needed the blood pressure machine. Firefighter Mazza saw medical personnel had begun cardiopulmonary resuscitation (CPR) on Decedent Okobi. Firefighter Mazza said he brought the blood pressure machine over and began assisting in the treatment of Decedent Okobi. Firefighter Mazza said as they were preparing the subject for an Intraosseous Infusion into the bone marrow in the subject's shin, he heard the "flatline" on the blood pressure machine. Firefighter Mazza assisted in preparing an Epinephrine injection and ultimately assisted in placing Decedent Okobi on a gurney for transportation to the hospital.



**Statement of Firefighter-Paramedic David Novelli:**

Detective Joshua McQuade conducted an interview with David Novelli on October 3, 2018. David Novelli is a firefighter-paramedic with the Central San Mateo County Fire Department and was part of the response to the scene on Engine #37. Firefighter Novelli said he observed an injured Sheriff's Deputy (Deputy Wang) who had abrasions on the left side of his face. Firefighter Novelli said he saw Decedent Okobi seated on the ground with his back being propped up by two (2) Sheriff's Deputies. Firefighter Novelli said a paramedic from AMR arrived on scene and together they assessed Decedent Okobi for his level of alertness. Firefighter Novelli said Decedent Okobi did not respond so he and the AMR paramedic both checked Okobi for a pulse and agreed he had one. Firefighter Novelli said while checking the subject's pulse, Decedent Okobi shook his head back and forth twice. Firefighter Novelli said the scene was chaotic so they elected to move Decedent Okobi to the back of an ambulance. Firefighter Novelli said by the time the AMR paramedic returned with a gurney and stretcher, they noted a change in Decedent Okobi's appearance and checked his pulse again. Firefighter Novelli said they were unable to locate a pulse and initiated CPR.

Firefighter Novelli said he relinquished the scene to paramedic-intern from San Bruno Fire Engine #51 and continued with providing CPR to Decedent Okobi. Firefighter Novelli said he contacted Deputy Wang after the first round of CPR was complete to get a better idea of what transpired. Firefighter Novelli said Deputy Wang told him he deployed his Taser and pressed the Taser trigger two (2) to three (3) more times. Deputy Wang also told firefighter Novelli he had thought another deputy may have also deployed their Taser and that "OC spray" (pepper spray) may also have been utilized.

Firefighter Novelli returned to attending to Decedent Okobi and cut off Okobi's clothing. Firefighter Novelli said he saw no visible injuries on Decedent Okobi other than a Taser probe in Okobi's chest just to the right of his sternum. Firefighter Novelli said Decedent Okobi did not make any statements or speak at any time. Firefighter Novelli said he returned to the fire engine to retrieve additional equipment and when he returned, other medical personnel were putting Decedent Okobi on a gurney and loading him into an ambulance. Firefighter Novelli said he transitioned to treating Deputy Wang and went to Mills-Peninsula Hospital in the back of AMR unit 94 with Deputy Wang. Firefighter Novelli said Deputy Wang complained of pain to the left side of his face, the right side of his neck and his right wrist. Firefighter Novelli said the lacerations on Deputy Wang's face did not appear to be "deep" and were no longer actively bleeding when he treated him.

**Statement of Emergency Medical Technician (EMT) Ferdinand Retanubun:**

Detective Joshua McQuade conducted an interview with Ferdinand Retanubun on October 3, 2018. Ferdinand Retanubun is an Emergency Medical Technician (EMT) for American Medical Response (AMR) and was assigned to ambulance #94. EMT Retanubun said he saw a subject



(Decedent Okobi) on the ground near a gurney with his hands handcuffed behind his back. EMT Retanubun said Decedent Okobi was motionless and he heard someone say, “check to see if he’s breathing”. EMT Retanubun said his unit was assigned to treat the injured deputy who was bleeding from the face (Deputy Wang). EMT Retanubun said he was walking Deputy Wang to their ambulance to treat his injuries when he saw the other medical personnel on the scene were applying life saving measures on Decedent Okobi and assumed Okobi had gone into cardiac arrest. EMT Retanubun went to assist in rendering aid to Decedent Okobi and left Deputy Wang with paramedic Patrick Pham.

EMT Retanubun eventually relieved another medic at the scene and took over administering CPR to Decedent Okobi. EMT Retanubun said Decedent Okobi was attached to an ECG machine and did not have a pulse while he was administering CPR. EMT Retanubun said Decedent Okobi was eventually loaded into AMR ambulance #37 and transported to the hospital. Because he had been the one applying CPR to Decedent Okobi at the time, EMT Retanubun rode in the ambulance with Okobi and was able to confirm medical aid was provided to Decedent Okobi the entire way to the hospital. EMT Retanubun said he did not see any visible injuries on Decedent Okobi other than a Taser probe stuck in the right side of Okobi’s chest.

**Statement of Paramedic Patrick Pham:**

Detective Joshua McQuade conducted an interview with Patrick Pham on October 3, 2018. Patrick Pham is a Paramedic for American Medical Response (AMR) and was assigned to ambulance #94. Pham said he was assigned to attend to two (2) Sheriff’s Deputies whom he described as an Asian deputy with abrasions to his face (Deputy Joshua Wang) and a bald deputy who had been exposed to pepper spray (Deputy Bryan Watt). Paramedic Pham said Deputy Wang was being treated by a firefighter when he arrived, so he did not get a good look at the injuries, which he described as a laceration on the left side of Deputy Wang’s face. Paramedic Pham said he saw a shirtless subject on his back on the ground (Decedent Okobi) being treated by a paramedic. Paramedic Pham said he overheard somebody say Decedent Okobi did not have a pulse and CPR was initiated on Okobi. Paramedic Pham said he never heard Decedent Okobi say anything while he was on scene and did not observe any injuries on Okobi. Paramedic Pham said he observed the medical personnel treating Decedent Okobi and saw they placed Okobi on a monitor, provided CPR, ventilation, and administered Epinephrine.

**Statement of Paramedic-Intern Gabriel Richardson:**

Detective Joshua McQuade conducted an interview with Gabriel Richardson on October 3, 2018. Gabriel Richardson is a firefighter for the San Bruno Fire Department who was interning as a paramedic on Engine #51. Intern Richardson said he saw a subject on the ground (Decedent Okobi) and was informed by other medical personnel on the scene that Okobi was in full cardiac arrest. Intern Richardson said during the treatment of Decedent Okobi, medical personnel provided four (4) doses of Epinephrine, established an airway, and provided CPR. Intern Richardson said two

(2) doses of Epinephrine were administered at the scene and two (2) were administered while Decedent Okobi was in the ambulance and on the way to the hospital. Intern Richardson said he did not observe any visible injuries on Decedent Okobi and said Okobi was unresponsive the entire time he was attending to him.

**Statement of Firefighter Paramedic Michael Paulin:**

Detective Joshua McQuade conducted an interview with Michael Paulin on October 3, 2018. Michael Paulin is a firefighter-paramedic with the San Bruno Fire Department and was part of the response to the scene on Engine #51. Firefighter Paulin said he was assigned to prepare an intravenous line for the subject (Decedent Okobi) who was being treated at the scene. Firefighter Paulin said he established an intravenous line and determined it was flowing properly before being tasked with providing resuscitative medicine through the line. Firefighter Paulin said he provided two (2) doses of Epinephrine to Decedent Okobi during treatment and did not provide any other medications. Firefighter Paulin said he also assisted another paramedic in establishing an airway on Decedent Okobi and assisted in placing Okobi on a gurney and into an ambulance. Firefighter Paulin said he did not see any visible injuries on Decedent Okobi and did not hear Okobi say anything because the subject was in full arrest when he arrived. Firefighter Paulin said he assisted in attending to an injured deputy who appeared to have a laceration or abrasion on his head (Deputy Wang) but did not hear any details from Deputy Wang about what had occurred.

**Statement of Emergency Medical Technician (EMT) Suzanne Holman:**

Detective Joshua McQuade conducted an interview with Suzanne Holman on October 4, 2018. Suzanne Holman is an Emergency Medical Technician for American Medical Response (AMR) and was assigned to ambulance #37. EMT Holman stated she observed a subject in a seated position (Decedent Okobi) being propped up by a Deputy who was standing directly behind Okobi when she arrived. EMT Holman observed a firefighter-paramedic check Decedent Okobi for a pulse and state he felt a “weak one”. EMT Holman said the same firefighter-paramedic conducted a sternum rub on Decedent Okobi and Okobi did not appear to respond. EMT Holman said she was assigned to prepare her ambulance for “trauma transport” and was later instructed to get breathing equipment ready because Decedent Okobi had gone in to full cardiac arrest. EMT Holman said upon returning from the ambulance, she saw CPR had been initiated on Decedent Okobi. EMT Holman said she never heard Decedent Okobi make any statements and said Okobi was completely unresponsive when she was present. EMT Holman noted Decedent Okobi had a Taser probe still lodged in his “right flank” and noted Okobi had several scrapes on his hands and a few abrasions on his back. EMT Holman did not know if the scratches and abrasions occurred during CPR or if they were there previously. EMT Holman said she transported Decedent Okobi to the hospital in AMR #37 and confirmed life saving measures were provided during the entire drive to the hospital. EMT Holman said she overheard conversations about how Decedent Okobi had been combative and that it took multiple deployments of a Taser to get him into custody.

**Statement of Paramedic Forrest Uhland:**

Detective Joshua McQuade conducted an interview with Forrest Uhland on October 4, 2018. Forrest Uhland is a Paramedic for American Medical Response (AMR) and was assigned to ambulance #37. Paramedic Uhland said he first noticed a Sheriff's Deputy with a "massive scrape" on his face (Deputy Joshua Wang) which was bleeding when he arrived. Paramedic Uhland said he was going to attend to Deputy Wang, but saw a subject seated on the ground, slumped over and drooling (Decedent Okobi). Paramedic Uhland said he went to check Decedent Okobi for a pulse at the carotid artery and was told by a firefighter already with Okobi "yup, we've got a pulse". Paramedic Uhland said Decedent Okobi was moving when he first saw him; however, said after a few minutes, everyone around Decedent Okobi noted he was no longer responding. Paramedic Uhland said the change in Decedent Okobi was "night and day". Paramedic Uhland said Decedent Okobi was checked again for a pulse, but they could not feel one. Paramedic Uhland said Decedent Okobi was placed on his back on the ground with his hands still behind his back when they initiated CPR. Paramedic Uhland said he coordinated the scene and did not render any medical aid to Decedent Okobi personally. Paramedic Uhland did observe a firefighter maintaining an airway on Decedent Okobi, another applying chest compressions, and a third one establishing an intravenous line in Okobi's shin. Paramedic Uhland said Decedent Okobi received two (2) doses of Epinephrine at the scene, Okobi did not ever regain consciousness and his heart rate never changed from the initial "flat-lined" reading. Paramedic Uhland said due to the cardiac arrest being witnessed by them, Decedent Okobi was transported to the hospital in AMR #37. During transportation to the hospital, Paramedic Uhland said Decedent Okobi received two (2) more doses of Epinephrine and life saving measures were conducted the entire drive.

Paramedic Uhland said he saw visible scrapes on Decedent Okobi's knuckles and hands but felt these injuries may have gotten worse during CPR since Okobi was still handcuffed with his hands behind him. Paramedic Uhland described Decedent Okobi as looking "drunk out of his mind". Paramedic Uhland did observe one (1) Taser prong in Decedent Okobi's right chest area and saw a copper wire underneath Okobi when he was laying on his back. Paramedic Uhland said he also noted the presence of the injured Sheriff's Deputy (Deputy Wang) and noted dried blood on Deputy Wang's face. Paramedic Uhland said the injury looked to him as if someone had "clawed" Deputy Wang on the left side of his face. Paramedic Uhland stated when he observed Deputy Wang and his injuries, he thought to himself "Man, he's been through it. They really fought".

**STATEMENTS OF INVOLVED OFFICERS:****Statement of Deputy Joshua Wang:**

Deputy Joshua Wang was interviewed by Inspector Rick Decker on October 4, 2018 at the San Mateo County District Attorney's Office. Present for this interview was Deputy Wang's attorney Zebulon Davis with Mastagni Holstedt, APC. At the request of Deputy Wang and Mastagni Holstedt, APC Deputy Wang reviewed footage from his Mobile Audio Video (MAV) recorder as



well as the video footage captured by witness Robert Garrison. The audio for Garrison's video footage was removed prior to Deputy Wang viewing the video.

Deputy Joshua Wang has been employed as a Deputy Sheriff with the San Mateo County Sheriff's Office for approximately eight (8) months. Prior to employment with the Sheriff's Office, Deputy Wang was employed as a police officer with the San Francisco Police Department. During his time with the San Mateo County Sheriff's Office, Deputy Wang has been assigned to the Patrol Bureau. While employed with the San Francisco Police Department, Deputy Wang was assigned to the Patrol Division and to the Specialist Team which would respond to in-progress critical incidents, assist the SWAT team with high-risk search warrants and work security details for gatherings and protests.

On October 3, 2018 Deputy Wang was assigned to work patrol out of the Millbrae Patrol Bureau, working a normally scheduled 6:00 AM to 6:00 PM patrol shift. Deputy Wang was driving San Mateo County Sheriff's Office vehicle #10, a fully marked Ford Explorer police vehicle equipped with functioning code-3 lighting equipment and a Mobile Audio Video (MAV) recording system. Deputy Wang was wearing a full, long-sleeved wool police uniform with Sheriff's Office patches affixed to both shoulders and a metal badge and metal name tag affixed to the chest. Deputy Wang did not utilize an external ballistic vest carrier and carried all equipment on his duty belt.

Deputy Wang worked an overtime patrol shift assigned to the Millbrae Patrol Bureau on October 2, 2018, working the same 6:00 AM to 6:00 PM shift as his normal work schedule. On October 3, 2018 Deputy Wang was driving his patrol vehicle southbound on El Camino Real, approaching the intersection of Millwood Drive when he observed a male subject (Decedent Okobi) walking eastbound on Millwood crossing El Camino Real while the light was green for southbound traffic on El Camino Real. Deputy Wang decided to conduct a traffic stop, activated his overhead emergency lighting equipment and conducted a U-turn to contact Decedent Okobi. Deputy Wang described Decedent Okobi as an "African-American male, fairly large in stature, carrying numerous bags". Deputy Wang said he pulled alongside Decedent Okobi and said something like "Hey I need to talk to you" or "Hey, stop. Hold on for a minute". Deputy Wang said Decedent Okobi ignored him and continued walking north along El Camino Real. Deputy Wang said he drove past Decedent Okobi and attempted to exit his vehicle and contact Okobi on foot. Deputy Wang said Decedent Okobi was walking in the lanes of traffic, creating a hazard for oncoming traffic. Deputy Wang stated, "I was bound to this subject now" and "I thought I can't just drive away. Now he's walking in traffic. He may get struck by a vehicle Um, he may cause an accident".

Deputy Wang said he notified San Mateo County Public Safety Communications he was attempting to conduct a pedestrian stop and needed assistance. Deputy Wang said he believed he would need assistance in safely contacting the subject in the busy roadway given the high volume of traffic at the time. Deputy Wang described Decedent Okobi as walking within the northbound



traffic lanes, on the center median, and veering into the southbound lanes. Deputy Wang said Decedent Okobi was causing a traffic hazard by causing cars to maneuver around Okobi to keep from hitting him. Deputy Wang said, “it seemed he had no regard for his own safety or the safety of other people that were in the roadway”. Deputy Wang stated the fact Decedent Okobi was walking in the roadway for an extended period was creating an “exigent public safety” matter and noted Okobi continued to ignore his constantly activated emergency lighting equipment.

Deputy Wang said he was preparing to make a U-turn southbound on El Camino Real to re-approach Decedent Okobi who was now travelling southbound when he saw multiple Sheriff’s Office vehicles approaching the subject “code-3”. Deputy Wang saw Deputy Alyssa Lorenzatti arrive and exit her patrol vehicle. Deputy Wang saw Deputy Lorenzatti approach Decedent Okobi and make a “forceful” hand motion he interpreted as Deputy Lorenzatti ordering Okobi to the ground or ordering him to drop his bags. Deputy Wang also saw Deputy John DeMartini arrive and join Deputy Lorenzatti. Deputy Wang said he became concerned for the safety of both officers as Decedent Okobi was clearly much larger than both deputies and would possibly be able to overpower them if the altercation escalated to some type of physical altercation”. Deputy Wang saw both Deputy Lorenzatti and Deputy DeMartini attempt to grab Decedent Okobi’s arms; however, Okobi was able to pull away from their grasp. Deputy Wang exited his own patrol car and ran toward Decedent Okobi and grabbed Okobi’s right hand to move the arm to the small of Okobi’s back in a control hold. Deputy Wang said he was not able to get the subject’s hand behind his back because “his level of resistance was much stronger than my level of force and I could tell quickly I wasn’t going to be able to physically gain control of him myself”. When asked why he wanted to detain Decedent Okobi in handcuffs, Deputy Wang said “his behavior was unpredictable. He would not acknowledge any of my commands. He had already – like I said earlier, displayed pre-indications that he was trying to evade detention by - by creating distance between myself and him and based on his physical stature, I thought in order to prevent him from attacking us, I felt safer in having him in handcuffs before we try to engage in some kind of meaningful dialogue”.

Deputy Wang said he unholstered his Taser to “try another force option beyond physical control”. Deputy Wang said he deactivated the thumb safety on the Taser, aimed the device at Decedent Okobi’s chest and stated, “If you don’t comply. Or don’t get on the ground then you’ll get Tased”. Deputy Wang said Decedent Okobi ignore him, so he deployed his Taser. Deputy Wang believed the Taser was effective in that he saw Decedent Okobi experience “some discomfort” and believed Okobi fell to the ground. After the Taser deployment, Deputy Wang said he notified county communications of the Taser deployment and to have paramedics respond and stage per San Mateo County Sheriff’s Office policy. Deputy Wang said the other involved deputies on scene tried unsuccessfully to detain Decedent Okobi while he was on the ground. Deputy Wang noted Decedent Okobi continued to resist commands to get on his stomach. Because of the continued resistance and refusal to comply, Deputy Wang activated his Taser a second time while the Taser

probes were still attached to Decedent Okobi. Deputy Wang said he did not believe the second Taser activation had any effect on Decedent Okobi and did not know if the probes were still attached to Okobi or not.

Deputy Wang described Decedent Okobi as “still very much agitated, he was speaking incoherently. He was moving, he was, um very excited” and said Okobi continued to refuse to comply with orders to roll on to his stomach. Deputy Wang said he activated the Taser, utilizing the same attached probes, a third time and stated, “I hoped he would just give up and surrender”. Deputy Wang could not recall if Decedent Okobi showed any effects of the third Taser activation. Deputy Wang described Decedent Okobi as still “uncompliant” and said Okobi’s body language never indicated an intent to “surrender”.

Deputy Wang recalled having seen Deputy Bryan Watt attempt to place Decedent Okobi in a control hold, but Okobi was able to pull away from Deputy Watt. Deputy Wang said he could see Decedent Okobi was still resisting and believed he activated his Taser for the fourth time, still using the same probes still attached to Okobi. Deputy Wang said Decedent Okobi continued to ignore orders from multiple officers and was able to get back up on his feet. Deputy Wang said he realized at that point his Taser had been “totally ineffective” as a means to detain Decedent Okobi. Deputy Wang recalled activating the Taser one (1) more time and recalled hearing a “clicking” sound from the Taser and recalled someone (unknown who) told him to “turn it off”.

Deputy Wang said he discarded his Taser in the roadway and expanded his ASP collapsible baton with his right hand as Decedent Okobi continued to move away from he and the other involved deputies while they all moved eastbound across El Camino Real. Deputy Wang said he attempted to strike Decedent Okobi with the baton by striking toward Okobi’s lower leg, however the baton did not contact Okobi. Deputy Wang said he then “felt him tackle me” and felt him “grab onto me and kinda pull me to the ground” Deputy Wang said “I saw something out of the corner of my eye and I felt like a hot stinging pain on the left side of my face. I didn’t black out but knew something had hit me on the face”. Deputy Wang said he felt Decedent Okobi pulling on his duty belt while Deputy Wang was on the ground and recalled having tried to stand up and punch Okobi to try and defend himself but was not sure if he connected with the punch or not. Deputy Wang then took out his pepper spray and deployed it at Decedent Okobi’s face but immediately heard the other involved deputies scream in pain which made him realize he had missed the subject with the pepper spray.

Deputy Wang said he recalled looking up, or standing up at some point, and seeing Decedent Okobi had been placed in handcuffs. Deputy Wang said Decedent Okobi was still thrashing about and the other deputies were trying to prevent Okobi from getting up. Deputy Wang recalled Decedent Okobi was still “making noises” and was still breathing. Deputy Wang said the other deputies moved Decedent Okobi into a seated position and he helped support Okobi upright

utilizing his legs at Okobi's back. Deputy Wang said someone told him to "go sit down" and he was relieved from propping up Decedent Okobi. Deputy Wang said he eventually saw CPR being performed on Decedent Okobi prior to Deputy Wang being escorted to an ambulance after he realized he was bleeding.

**Statement of Deputy Alyssa Lorenzatti:**

Deputy Alyssa Lorenzatti was interviewed by Inspector Eric Suzuki on October 4, 2018 at the San Mateo County District Attorney's Office. Present for this interview was Deputy Lorenzatti's attorney Zebulon Davis with Mastagni Holstedt, APC. At the request of Deputy Lorenzatti and Mastagni Holstedt, APC, Deputy Lorenzatti viewed the footage from her Mobile Audio Video (MAV) recorder as well as the video footage captured by witness Robert Garrison. The audio for Garrison's video footage was removed prior to Deputy Lorenzatti viewing the video.

Deputy Alyssa Lorenzatti has been employed as a Deputy Sheriff for the San Mateo County Sheriff's Office for approximately two (2) years. Prior to being hired by the Sheriff's Office, Deputy Lorenzatti was employed as a police officer with the California Highway Patrol (CHP) for approximately three (3) years.

On October 3, 2018, Deputy Lorenzatti was assigned to the Millbrae Patrol Bureau and was working her normally assigned 6:00 AM to 6:00 PM shift. Deputy Lorenzatti stated October 3, 2018 was the first day of her work week and she did not respond to any stressful or unusual calls for service prior to the incident. Deputy Lorenzatti was driving San Mateo County Sheriff's Office vehicle #8, a fully marked Ford Taurus police vehicle equipped with functioning code-3 lighting equipment and a Mobile Audio Video (MAV) recording system. Deputy Lorenzatti was wearing a full, short-sleeved wool police uniform with Sheriff's Office patches affixed to both shoulders with a metal badge and metal name tag affixed to the chest area. Deputy Lorenzatti did not utilize an external ballistic vest carrier at the time of this incident.

Deputy Lorenzatti stated she was in the report writing room at the Millbrae Police Substation when she heard Deputy Joshua Wang broadcast over the radio he was contacting a subject. Deputy Lorenzatti heard Deputy Wang come over the radio and request "Code 3 cover" and say that someone was running in traffic in the northbound lanes of traffic for El Camino Real near Millwood Drive. Deputy Lorenzatti said she ran out to her patrol vehicle and saw Deputy Bryan Watt and Sergeant David Weidner also going to their respective patrol vehicles. Deputy Lorenzatti activated her lighting equipment and siren and responded to the scene. Deputy Lorenzatti said when she arrived in the area, she observed a large black male wearing a blue shirt (Decedent Okobi) run across the lanes of traffic from northbound El Camino Real to southbound El Camino Real.



Deputy Lorenzatti said she approached Decedent Okobi's location by driving northbound in the southbound lanes of El Camino Real. Deputy Lorenzatti described Decedent Okobi as being over six (6) feet tall and approximately 300 pounds. Deputy Lorenzatti said Decedent Okobi was carrying two (2) large black bags in his hand and was walking southbound on the west sidewalk of El Camino Real when she first approached him. Deputy Lorenzatti said she told Decedent Okobi to stop and put the bags he was carrying down. Deputy Lorenzatti said Decedent Okobi said something like "I didn't do nothing" or "I didn't do anything". Deputy Lorenzatti said she repeated her order for Decedent Okobi to stop; however, Decedent Okobi stared directly at Deputy Lorenzatti and continued to walk straight toward her. Deputy Lorenzatti said she felt like "he was going to run me over if I didn't get out of his way." Deputy Lorenzatti added "he had this look in his eyes, that he wasn't quite all there. He seemed like he might have been under the influence of something. I wasn't really sure".

Deputy Lorenzatti said Decedent Okobi continued to ignore her orders and walk toward her, so Deputy Lorenzatti said she sidestepped Okobi and attempted to grab his left arm to detain him based upon Deputy Wang's radio traffic and Okobi's lack of acknowledgement of her verbal commands. Deputy Lorenzatti said Decedent Okobi pulled away from her attempt at a control hold and continued to travel past her. Deputy Lorenzatti said she tried a second time to grab Decedent Okobi's arm but he flung his arms up in the air away from her. Deputy Lorenzatti said due to Decedent Okobi's active resistance of her efforts to detain him, she felt she needed to try and take Decedent Okobi to the ground to gain better control of him. Deputy Lorenzatti noted Decedent Okobi was too big to control and her other efforts thus far had been ineffective. Deputy Lorenzatti said she attempted to sweep Decedent Okobi's leg to bring him to the ground, but the technique did not work. Deputy Lorenzatti described Decedent Okobi as waving his arms wildly in the air and swinging his fists. Deputy Lorenzatti said she heard Deputy Wang tell Decedent Okobi to stop and warned Decedent Okobi multiple times he would be "tased".

Deputy Lorenzatti said Deputy Wang deployed his Taser and Decedent Okobi fell to the ground. Deputy Lorenzatti said she planned on moving in quickly to handcuff Decedent Okobi but when Okobi fell, he fell away from Deputy Lorenzatti. Deputy Lorenzatti said Decedent Okobi had already rolled onto his back by the time she got to him. Deputy Lorenzatti recalled hearing the involved deputies tell Decedent Okobi multiple times to get on his stomach. Deputy Lorenzatti said she tried to grab Decedent Okobi's arm to roll him on his stomach but was unsuccessful. Deputy Lorenzatti said Decedent Okobi then attempted to grab her legs. Deputy Lorenzatti said Decedent Okobi continued to ignore their commands to turn over on to his stomach and recalled from having watched the videos before the interview that Decedent Okobi was able to get back up and was tased a second time. Deputy Lorenzatti said Decedent Okobi fell to the ground again but was able to get back up quickly and started to run away.

Deputy Lorenzatti said she saw Deputy Wang get in front of Decedent Okobi and take out his ASP (collapsible baton). Deputy Lorenzatti said Deputy Wang yelled for Decedent Okobi to stop and she saw Deputy Wang swing the ASP at the subject; however, she did not see how many times Deputy Wang swung the ASP nor whether he connected with any of the strikes. Deputy Lorenzatti said Decedent Okobi appeared fixated on Deputy Wang and she saw Okobi swing at Deputy Wang. Deputy Lorenzatti did not know if Decedent Okobi hit Deputy Wang with the strike or not. Deputy Lorenzatti then saw another deputy (she was unable to determine who) tackle Decedent Okobi and take him to the ground. Deputy Lorenzatti said she then got on top of Decedent Okobi while Okobi continued to fight, kick, and not provide his hands to deputies despite continued commands to “Give us your hands, give us your hands. Stop resisting”.

Deputy Lorenzatti said she was hit in the face with pepper spray which was deployed from an unknown source. Deputy Lorenzatti said Decedent Okobi was continuing to fight while she was blinded by the effects of the pepper spray. Deputy Lorenzatti said she put all her body weight on Decedent Okobi. While trying to control Decedent Okobi, Deputy Lorenzatti said she did punch Okobi in the lower half of his body to “jolt his arm out” but said her blows were not effective. Deputy Lorenzatti said she did not ever use her ASP as she feared Decedent Okobi would have been able to take the ASP away from her given his size and strength. Deputy Lorenzatti recalled handing her handcuffs to another deputy (unknown to her which one) while she remained positioned on Decedent Okobi’s lower body until she heard Okobi was handcuffed. Prior to Decedent Okobi being placed in handcuffs, Deputy Lorenzatti recalled Sergeant Weidner broadcast a request for medics to be summoned the scene.

Deputy Lorenzatti said that once Decedent Okobi was detained in handcuffs, they rolled Okobi on to his side and then moved him into a seated position. Deputy Lorenzatti said paramedics arrived on the scene and she recalled seeing a paramedic determine Decedent Okobi did have a pulse. Deputy Lorenzatti said at some point, Decedent Okobi stopped responding to pain stimulus and the paramedics put Decedent Okobi on his back and initiated CPR.

Deputy Lorenzatti said she suffered minor scrapes on her right wrist and right forearm at some point during the struggle with Decedent Okobi; however, did not know when they occurred. Deputy Lorenzatti was asked if she felt her CIT training could have been used to de-escalate the situation with Decedent Okobi. Deputy Lorenzatti stated “Everything happened very fast and from the moment that I got on scene, he wasn’t listening to anything we said, and he was becoming more and more of a risk as it went on to the public and to us”.

**Statement of Sergeant David Weidner:**

I conducted an interview with Sergeant David Weidner on October 4, 2018 at the San Mateo County District Attorney’s Office. Present for this interview was Sergeant Weidner’s attorney Sarah Burdick with Rains Lucia Stern St. Phalle & Silver, PC. I spoke with Sarah Burdick before

the interview and learned Sergeant Weidner wished to provide a statement based upon his own memories and perceptions of the incident and did not want to view his Mobile Audio Video (MAV) footage or the footage captured by witness Robert Garrison prior to his statement.

Sergeant Weidner has been employed as a Deputy Sheriff with the San Mateo County Sheriff's Office for approximately sixteen and a half (16.5) years. Sergeant Weidner began his career with the Sheriff's Office as a Correctional Officer, where he served for approximately one and a half (1.5) years before promoting to Deputy Sheriff. Sergeant Weidner has been a Sheriff's Sergeant for approximately two (2) years. Prior to his employment with the Sheriff's Office, Sergeant Weidner was a reserve police officer with the South San Francisco Police Department and worked as a contractor for the United States Department of State working Federal building security. During his career with the Sheriff's Office, Sergeant Weidner has been assigned primarily to the Patrol Division but has also worked in the Corrections and Transportation Divisions. Sergeant Weidner has been a member of the Sheriff's Office Range Training staff for approximately ten (10) years and is currently one of the lead firearms instructors for the Sheriff's Office. Sergeant Weidner is a certified patrol rifle instructor and is a Taser and pepper spray instructor. Sergeant Weidner has twice attended Crisis Intervention Training (CIT) and has attended multiple courses designed to aid in the recognition of persons under the influence of a controlled substance.

On October 3, 2018 Sergeant Weidner was assigned as the Day Shift Patrol Sergeant for the Millbrae Patrol Bureau and was working his normally assigned 5:00 AM to 5:00 PM shift. Sergeant Weidner said October 3, 2018 would have been the first day of his work week had he not worked overtime on both of his scheduled days off that week, including an overtime shift in the Transportation Division working 7:00 AM to 5:00 PM on October 2, 2018. Sergeant Weidner was driving San Mateo County Sheriff's Office vehicle #1, a fully marked Ford Explorer police vehicle equipped with functioning code-3 lighting equipment and a Mobile Audio Video (MAV) recording system. The MAV system included a body-worn remote microphone which Sergeant Weidner said was affixed to chest during the incident. Sergeant Weidner was wearing a full police short-sleeved uniform with Sheriff's patches and Sergeant chevrons affixed to each sleeve. Sergeant Weidner was utilizing an exterior ballistic vest carrier at the time of the incident.

Sergeant Weidner stated he was at the Millbrae Police Substation doing administrative work when he heard Deputy Joshua Wang broadcast over the radio he was attempting to make a pedestrian stop. As time progressed, Sergeant Weidner recalled hearing Deputy Wang broadcast the subject had run from him into traffic that Deputy Wang later called for "code three cover". Sergeant Weidner said he responded to his patrol vehicle in the back lot of the substation and responded from the station along with Deputy Alyssa Lorenzatti, Deputy John DeMartini and Deputy Bryan Watt.



Sergeant Weidner said he drove his vehicle northbound in the southbound lanes of traffic of El Camino Real as he approached the scene in a manner to allow the MAV camera in his patrol vehicle the best angle to capture the incident. Sergeant Weidner did not recall hearing a description of the subject being broadcast by Deputy Wang. Upon arriving on the scene, Sergeant Weidner saw the other deputies attempting to contact a black male adult (Decedent Okobi). Sergeant Weidner said he first observed Decedent Okobi holding his hands up above his head and saw Deputy Wang approaching Okobi from behind. Sergeant Weidner said he thought Deputy Wang would be able to grab Decedent Okobi's arm and detain him and assumed Okobi was compliant since his hands were up. Sergeant Weidner said Decedent Okobi pulled his arms down, turned around and possibly pushed Deputy Wang. Sergeant Weidner said he saw Deputy Wang draw his Taser, point it at Decedent Okobi and activate his Taser. Sergeant Weidner said he could see Deputy Wang had gotten an effective Taser deployment and saw Decedent Okobi stagger and fall over backwards. Sergeant Weidner said he was approximately twenty (20) feet away from Deputy Wang's location when Deputy Wang deployed the Taser, but quickly rushed over to cover the distance when he saw Decedent Okobi fall. Sergeant Weidner said he could see the two (2) Taser probes in Decedent Okobi's right forearm and in Okobi's upper torso on the right side of his body.

Sergeant Weidner stated once Decedent Okobi was on the ground, he noted Okobi appeared to be under the influence of a controlled substance, likely PCP or "Bath Salts". Sergeant Weidner based this assessment on the fact Decedent Okobi was staring straight up into the sky and was "talking to God". Sergeant Weidner said he had personally been subjected to a full five (5) second Taser deployment when he attended Taser instructor school and knew the only physical response possible from a subject being tased was to either scream or be silent while the device is deploying a shock. Sergeant Weidner said he moved in to grab Decedent Okobi and roll him over onto his stomach, but Okobi pulled away from him "like I wasn't even there". Sergeant Weidner described Decedent Okobi as having "super human strength". Sergeant Weidner further described Decedent Okobi as having a "thousand-yard stare" and was talking straight up to the sky "like we weren't even there".

Sergeant Weidner said Decedent Okobi "leapt up" and Deputy Wang deployed a second activation of the Taser by re-engaging the Taser's trigger and utilizing the same probes. Sergeant Weidner said this caused Decedent Okobi to fall back down. Sergeant Weidner said he and the other involved deputies moved in to detain Okobi. Sergeant Weidner said Decedent Okobi continued to pull away from them because "he was way too strong". Sergeant Weidner said he observed one (1) of the Taser wires had broken, so he knew the Taser would be rendered ineffective. Sergeant Weidner said Decedent Okobi got back up and started to run diagonally across El Camino Real into the northbound traffic lanes with he and the other involved deputies following. Sergeant Weidner said Decedent Okobi continued to yell something "incoherent" and "something about God". Sergeant Weidner did describe Decedent Okobi as having "a second of clarity" and asking, "what did I do?" at one point when they were following him.

Sergeant Weidner said he saw Deputy Wang deploy his ASP (collapsible baton) and swing it at Decedent Okobi but could not tell if Deputy Wang's ASP strike hit Okobi or not. Sergeant Weidner said he could tell Deputy Wang had been struck at this time because he saw Deputy Wang's ASP and Taser "literally fly through the air" out of Deputy Wang's hands. Sergeant Weidner said he saw Decedent Okobi lower his center of gravity and "basically linebacker tackle" Deputy Wang. Sergeant Weidner described Decedent Okobi as using both hands to grab toward Deputy Wang's legs and put his shoulder into Deputy Wang's waist. Sergeant Weidner said he could see one (1) of Decedent Okobi's hands was on Deputy Wang's holster and firearm, grasping the top edge of the holster and the exposed portion of Deputy Wang's firearm. Sergeant Weidner said he worried they were going to get into an officer involved shooting and added "we had literally escalated through our entire use of force". Sergeant Weidner noted verbal commands, the Taser deployments, the use of the ASP and ultimately pepper spray as all being ineffective though he did point out pepper spray had not yet been deployed when he saw Decedent Okobi grasping Deputy Wang's holster and firearm.

Sergeant Weidner said Decedent Okobi went to the ground again, but he was unsure what caused Okobi to fall and speculated Okobi may have tripped. Sergeant Weidner said once Decedent Okobi was on the ground, he instructed the other deputies to "get on top of him" hoping they could control Okobi and try to get additional deputies to the scene to assist them. Sergeant Weidner said Deputy DeMartini was positioned at Decedent Okobi's feet, Deputy Lorenzatti was at Okobi's legs and Sergeant Weidner said he was trying to gain control of Decedent Okobi's right arm. Sergeant Weidner said Decedent Okobi's right forearm was bleeding "pretty profusely" from the Taser probe, which was still embedded in Okobi's arm. Sergeant Weidner said this was causing his hands to keep slipping off Decedent Okobi's arm as he tried to control it. Sergeant Weidner said pepper spray was deployed during the struggle with Decedent Okobi. Sergeant Weidner said he found out afterwards it was Deputy Wang who deployed the pepper spray, but he did not know it was Deputy Wang during the struggle. Sergeant Weidner speculated the pepper spray nozzle was positioned at an upward angle and missed Decedent Okobi's face because the spray instead hit Deputy Watt with a direct "shot to the face" which incapacitated Deputy Watt and caused him to have to remove himself from the struggle. Sergeant Weidner said Deputy Lorenzatti also received a direct shot from the pepper spray and was complaining she could not see and was having difficulty breathing. Sergeant Weidner said he instructed Deputy Lorenzatti to "hang in there" and "stay in the fight". Sergeant Weidner said he was struck with "splash back" from the pepper spray but was not affected as heavily as Deputy Watt and Deputy Lorenzatti.

Sergeant Weidner said he was able to get Decedent Okobi's arm out from under him and someone was able to place a handcuff on Okobi's wrist. Sergeant Weidner said he called for a second pair of handcuffs to link together because "there was no way we were getting his hands behind his back with one pair". Sergeant Weidner believed Deputy Wang was able to get Decedent Okobi's other

arm behind Okobi's back and someone was able to get Okobi fully handcuffed. Once Decedent Okobi was successfully in handcuffs, Sergeant Weidner said he immediately became concerned with the risk of positional asphyxia as they had been on top of Okobi. Sergeant Weidner said he directed the involved deputies to roll Decedent Okobi on his side and ultimately had them move him to a seated position. Sergeant Weidner estimated they had Decedent Okobi sitting up within approximately ten (10) seconds of being handcuffed. Sergeant Weidner said he checked Decedent Okobi for a pulse once he was in a seated position and described Okobi as initially being "not responsive" but said Okobi "all the sudden woke up" and was actively looking around.

Sergeant Weidner said he requested over the radio that fire and medical personal who had been staging near the scene come in to begin treating Decedent Okobi and the deputies. Sergeant Weidner said he noted Deputy Wang was bleeding "pretty profusely from the face" and wanted to get him treatment quickly as he did not know the severity of Deputy Wang's injuries. Sergeant Weidner said he was focused on establishing a crime scene and obtaining witness statements but recalled seeing paramedics attending to Decedent Okobi and described Okobi as being alert and looking around. Sergeant Weidner said Decedent Okobi "then all of the sudden coded" and recalled a paramedic yelling to a Fire Captain on scene that he needed to get a heart monitor on Okobi. Sergeant Weidner said the Captain did not hear the paramedic, so he went and relayed the message. Sergeant Weidner said all the medical personnel on the scene began attending to Decedent Okobi while Sergeant Weidner began activating the Officer Involved Critical Incident Protocol.

Sergeant Weidner described Decedent Okobi as "a very big guy" and estimated Okobi to be approximately six (6) feet or more in height and approximately 300 to 320 pounds in weight. Sergeant Weidner described having experience in the past with persons under the influence of both PCP and "Bath Salts" and felt Decedent Okobi was displaying the symptoms of being under the influence of one (1) of those substances. Sergeant Weidner added his belief that a person under the influence of PCP or "Bath Salts" and of Decedent Okobi's size meant there "was no stopping a man that size". Sergeant Weidner described one (1) of the key indicators to him Decedent Okobi was under the influence was the fact Okobi was able to continue talking through a Taser deployment and added "you can't do that, okay? That does not happen". Sergeant Weidner also based this belief on Decedent Okobi's lack of responsiveness to pain and "his literally super human strength". Sergeant Weidner told me mental health conditions can factor in to the effectiveness of the Taser, but it was his belief Decedent Okobi was under the influence of a controlled substance.

Sergeant Weidner said he did not utilize any of his own less-lethal weapon options during the incident. Sergeant Weidner explained he already knew Deputy Wang's Taser deployment had been ineffective in incapacitating Decedent Okobi and knew his own Taser would have the same lack of effect. Sergeant Weidner added his belief the ASP (collapsible baton) would not be an effective option on a person of Decedent Okobi's size and knew the next level of escalation would have



been deadly force, which he was trying to avoid when he instructed the other deputies to get on top of Okobi once he was on the ground. Sergeant Weidner explained that as a Taser instructor, he teaches deputies that if one (1) Taser is not working on a subject, the other person's will not work either and teaches them not to deploy the Taser in that situation. I asked Sergeant Weidner if he sustained any injuries during the attempts to take Decedent Okobi into custody. Sergeant Weidner said he had some soreness in his back and legs from the exertion in attempting to control Decedent Okobi and was feeling some residual effects of the pepper spray, but he did not seek any medical attention. Sergeant Weidner also had a scratch on his right hand which he sustained during the incident.

I talked with Sergeant Weidner about the need to contact someone running in and out of traffic in this situation. Sergeant Weidner said the behavior sounded to him like a person under the influence of drugs or alcohol and pointed out running in and out of traffic on a busy roadway such as El Camino Real made the subject a danger to members of the public and to himself. Sergeant Weidner added "no normal person runs in and out of traffic". Sergeant Weidner noted El Camino Real has a very high volume of traffic and the City of Millbrae has a high occurrence of accidents in which pedestrians are struck by cars.

**Statement of Deputy Bryan Watt:**

I conducted an interview with Deputy Bryan Watt on October 5, 2018 at the San Mateo County District Attorney's Office. Present for this interview was Deputy Watt's attorney Gregory Thoming with Mastagni Holstedt, APC. At the request of Deputy Watt and Mastagni Holstedt, APC, Deputy Watt viewed footage from his Mobile Audio Video (MAV) recorder as well as video footage captured by witness Robert Garrison. The audio for Garrison's video footage was removed prior to Deputy Watt viewing the video.

Deputy Watt has been employed as a Deputy Sheriff with the San Mateo County Sheriff's Office for approximately twenty-three (23) years. Deputy Watt served as a Correctional Officer for the first five (5) years of his career before promoting to the position of Deputy Sheriff eighteen (18) years ago. Deputy Watt was not employed by any other police agency prior to joining the San Mateo County Sheriff's Office. During his career with the Sheriff's Office, Deputy Watt has been assigned primarily to the San Mateo County Jail and the Patrol Bureau. Deputy Watt has attended a three (3) day course provided by the San Mateo County Narcotics Task Force which provided training in recognizing subjects under the influence of controlled substances and has also attended Crisis Intervention Training (CIT).

On October 3, 2018, Deputy Watt was assigned to the Millbrae Patrol Bureau and was working his normally assigned 6:00 AM to 6:00 PM shift. Deputy Watt stated October 3, 2018 was the first day of his regular work week; however, he had worked two (2) days of overtime working similar day shift hours on October 1, 2018 and October 2, 2018. Deputy Watt was driving San Mateo

County Sheriff's Office vehicle #37, a fully marked Ford Explorer police vehicle equipped with functioning code-3 lighting equipment and a Mobile Audio Video (MAV) recording system. Deputy Watt said he reported the body-worn microphone for the MAV in vehicle #37 missing at the start of his shift. Deputy Watt was wearing a full, short-sleeved police uniform with Sheriff's Office patches affixed to both shoulders. Deputy Watt said he utilized an external ballistic vest carrier at the time of this incident which had a metal badge and metal name tag affixed to the exterior of the vest.

Deputy Watt said he was inside the Millbrae Police Substation conducting follow-up on an unrelated investigation when he heard Deputy Joshua Wang over the police radio asking for an additional unit. Deputy Watt said Deputy Alyssa Lorenzatti was at the substation and he saw her leave to go respond to cover Deputy Wang. Deputy Watt said he then heard Deputy Wang broadcast again asking for "code 3 cover". Deputy Watt said he went to his patrol vehicle and responded to Deputy Wang's location "code three". Deputy Watt said when he arrived on scene, he saw two (2) to three (3) marked patrol vehicles in the southbound lanes of traffic on El Camino Real in front of the Tri Counties Bank. Deputy Watt said he first saw an unidentifiable deputy already on scene in the number three (3) lane of traffic with his or her back to Deputy Watt. Deputy Watt said he saw a subject on the ground (Decedent Chinedu Okobi) in a lane of traffic who had already been tased and had Taser wires extending from his person to a Taser in the hand of Deputy Wang. Deputy Watt said the one (1) of the Taser probes appeared to be in the back of what he thought was Decedent Okobi's left hand. Deputy Watt described Decedent Okobi as "a big person" and estimated Okobi to be between 6' to 6'3" tall and weighing "at least three hundred pounds". Deputy Watt said Decedent Okobi was on his back and he saw both Deputy Lorenzatti and Sergeant Weidner attempting to convince Okobi to roll over on his stomach. Deputy Watt saw "somebody" try to grab one of Decedent Okobi's hands but Okobi pulled his hand away.

Deputy Watt said Decedent Okobi was not physically resisting but was also not complying with the commands he was being given. Deputy Watt said Decedent Okobi was "becoming more and more agitated" and was "rolling around". Deputy Watt said he tried to verbally engage Decedent Okobi by telling him to roll on to his stomach and warning Okobi he would be "tased again" if he did not comply. Deputy Watt could only recall hearing Decedent Okobi say something like "get them off me" or get them out of me" which Deputy Watt believed was a reference to the Taser probes in Okobi's body. Deputy Watt said he tried to reach out and grab one of Decedent Okobi's hands but Okobi kept pulling his hand away. Deputy Watt said Decedent Okobi was able to get back up on his feet and Deputy Wang activated his Taser a second time, causing Okobi to go to the ground again. Deputy Watt said the second activation of the Taser on Decedent Okobi was effective for only "a second or two" before Okobi was "able to fight through that". Deputy Watt said Decedent Okobi was able to get back on to his feet and Deputy Watt said he drew and extended his ASP (collapsible baton) but did not ever strike Okobi with it. Deputy Watt said Decedent Okobi

then began to move south-east across the lanes of traffic on El Camino Real away from the involved deputies.

Deputy Watt said once the group moved to the northbound lanes of traffic following Decedent Okobi, Deputy Wang drew and extended his ASP. Deputy Watt said Decedent Okobi had his hands around Deputy Wang's waist area and Deputy Wang struck decedent Okobi at least once with the ASP and appeared to break free from Decedent Okobi's grasp. Deputy Watt said he saw Decedent Okobi throwing punches "in about the face" of Deputy Wang once Deputy Wang broke free of Okobi's grasp but could not be certain the punches connected. Deputy Watt said Deputy John DeMartini was able to tackle Decedent Okobi and take Okobi to the ground. Deputy Watt said once Decedent Okobi was on the ground, he and the other involved deputies converged on Okobi and tried to gain physical control of Okobi. Deputy Watt said Decedent Okobi was "flailing around" and was able to turn over to the point where he was nearly on his back again during the struggle. Deputy Watt said Decedent Okobi had gotten up on his side when someone (unknown to him who) deployed pepper spray which struck Deputy Watt in the face and eyes.

Deputy Watt said he was blinded by the pepper spray deployment and removed himself from the struggle to get Decedent Okobi into handcuffs. Deputy Watt did recall giving his handcuffs to one of the other involved deputies and recalled Decedent Okobi being handcuffed with two (2) sets of linked handcuffs. Deputy Watt said Decedent Okobi was then turned on his side and was moved up to a seated position with Deputy Watt using his legs to support Okobi upright. Deputy Watt stated Decedent Okobi had his head facing down toward his chest when he was resting against Deputy Watt's legs. Deputy Watt said he was unsure if Decedent Okobi was breathing because he was not moving around to the extent Deputy Watt expected after the struggle. Deputy Watt said he tried to check Decedent Okobi for a pulse at the neck and Okobi immediately brought his head up and was looking around. Deputy Watt said he could see Decedent Okobi was breathing so he did not continue to check for a pulse. Deputy Watt said he was speaking to Decedent Okobi, telling him to relax and breath but he did not recall Okobi ever saying anything in response. Deputy Watt said he was relieved from his position supporting Decedent Okobi upright, so he could flush his eyes with water but did see paramedics arrive on scene and begin treating Okobi. Deputy Watt said he looked back a short time later and saw paramedics were performing CPR.

Deputy Watt stated he initially believed Decedent Okobi was possibly needed to be evaluated for a mental health hold but after observing Okobi's strength and the way Okobi was fighting off attempts to get him under control, Deputy Watt said he now believed Decedent Okobi was under the influence of a controlled substance. Deputy Watt did not utilize any of the weapons available to him during the incident and stated that other than the already discussed usage of the Taser and ASP by Deputy Wang and the use of pepper spray by someone unknown to him, none of the other involved deputies used any of their other weapon options on Decedent Okobi during the incident. Deputy Watt was asked whether his CIT training would have been effective in gaining Decedent



Okobi's compliance during the incident. Deputy Watt said due to the fact Decedent Okobi was already actively engaged in a fight, had already been tased and was either "not listening, not hearing or didn't want to talk", Deputy Watt did not believe any of the techniques he learned in CIT training could have been utilized in that situation. Deputy Watt was also asked if this was a situation where he felt he or the other involved deputies could have backed away and allowed Decedent Okobi to walk away from them. Deputy Watt said he would not have been able to walk away from Decedent Okobi because Okobi had already been tased when he arrived on scene and San Mateo County Sheriff's Office policy required they stay and seek medical help for Okobi once the Taser had been used. Deputy Watt also pointed out Decedent Okobi had already displayed a willingness to fight with law enforcement which Deputy Watt believed made it unsafe for Okobi to remain in the general public.

**Statement of Deputy John DeMartini:**

I conducted an interview with Deputy John DeMartini on October 5, 2018 at the San Mateo County District Attorney's Office. Present for this interview was Deputy DeMartini's attorney Gregory Thoming with Mastagni Holstedt, APC. At the request of Deputy DeMartini and Mastagni Holstedt, APC, Deputy DeMartini viewed footage from his Mobile Audio Video (MAV) recorder as well as video footage captured by witness Robert Garrison. The audio for Garrison's video footage was removed prior to Deputy DeMartini viewing the video.

Deputy DeMartini has been employed as a Deputy Sheriff with the San Mateo County Sheriff's Office for approximately seventeen (17) years. Prior to being employed by the San Mateo County Sheriff's Office, Deputy DeMartini was employed as a Deputy Sheriff for the San Francisco County Sheriff's Department for approximately four and a half (4.5) years. Deputy DeMartini was not employed by any other police agency prior to joining the San Francisco County Sheriff's Department. Prior to his law enforcement career, Deputy DeMartini served in the United States Army for approximately four (4) years and was not deployed to any conflict or combat situations. During his career with the San Mateo County Sheriff's Office, Deputy DeMartini has been assigned primarily to the Corrections, Transportation and Patrol Bureaus. Deputy DeMartini was also briefly assigned to the Civil Division when he worked for the San Francisco County Sheriff's Department. Deputy DeMartini has attended Crisis Intervention Training (CIT).

On October 3, 2018 Deputy DeMartini was assigned to work patrol out of the Millbrae Patrol Bureau working an overtime shift from 6:00 AM to 6:00 PM. On October 1, 2018 and October 2, 2018, Deputy DeMartini worked his normal assigned shift working the same 6:00 AM to 6:00 PM shift out of the Millbrae Patrol Bureau. Deputy DeMartini was driving San Mateo County Sheriff's Office vehicle #16, a fully marked Ford Taurus police vehicle equipped with functioning code-3 lighting equipment and a Mobile Audio Video (MAV) recording system. Deputy DeMartini was wearing a full, short-sleeved police uniform with Sheriff's Office patches affixed to both shoulders

with a metal badge and metal name tag affixed to the chest area. Deputy DeMartini did not utilize an external ballistic vest carrier at the time of this incident.

Deputy DeMartini said he was at the Millbrae Police Substation report writing area after finishing his lunch break. Deputy DeMartini said he heard a broadcast coming from Deputy Bryan Watt's radio. Deputy DeMartini said the volume knob on his radio had inadvertently been turned down when he sat in a chair, but Deputy Watt was near him, so he could hear his radio. Deputy DeMartini said he did not hear the content of the broadcast and Deputy Watt told him Deputy Wang was asking for an additional unit. Deputy DeMartini said Deputy Lorenzatti got up and left the report writing area to cover Deputy Wang. Deputy DeMartini said he turned his radio volume knob back up and heard Deputy Wang asking for "code three cover" as he and Deputy Watt were walking out to their own patrol vehicles.

Deputy DeMartini recalled Deputy Wang putting out a description of the subject of his stop as a "black male with bags". Deputy DeMartini said he responded to the area with his overhead lighting equipment and siren activated. Deputy DeMartini said he arrived in the area and saw a subject (Decedent Chinedu Okobi) walking south on El Camino Real. Deputy DeMartini said he could see Deputy Wang further north on El Camino Real and heard Deputy Wang broadcast that Decedent Okobi was walking southbound toward incoming units. Deputy DeMartini said Decedent Okobi was the only subject he saw in the area. Deputy DeMartini said he and Deputy Lorenzatti both exited their patrol vehicles and tried to contact the subject, saying something like "can we talk to you" and "let me see your hands". Deputy DeMartini said Deputy Lorenzatti attempted to grab Decedent Okobi but could not see where on Okobi Deputy Lorenzatti tried to grab as Okobi was between he and Deputy Lorenzatti. Deputy DeMartini said Decedent Okobi pulled away from Deputy Lorenzatti and noted Okobi had already discarded the bags he had been carrying when he first saw him. Deputy DeMartini said based upon his own experience, the act of discarding items was "somebody getting ready to use their hands. They don't want to be encumbered" which led Deputy DeMartini to believe Decedent Okobi was getting prepared to fight with them.

Deputy DeMartini said he attempted to grab Decedent Okobi by one of his wrists to place Okobi in a control hold, but Okobi pulled away from him and left Deputy DeMartini with a "handful of his sweater". Deputy DeMartini said Decedent Okobi was able to pull completely out of the sweater and break free from his attempts to detain him. Deputy DeMartini said he made a second attempt to grab Decedent Okobi, but Okobi pulled away again and Deputy Wang deployed his Taser, striking Decedent Okobi and causing Okobi to fall to the ground in the roadway. Deputy DeMartini said Decedent Okobi was lying supine on the ground so he and the other involved deputies began giving Okobi commands to roll over on to his stomach to handcuff him. Deputy DeMartini said he could see the Taser probes embedded in the right chest area and in the back of one of the hands of Decedent Okobi. Deputy DeMartini was uncertain which hand the second probe was in, but believed it was possibly in Okobi's left hand. Deputy DeMartini said Decedent

Okobi was not paying attention to their commands to roll over and was attempting to pull the Taser “leads” out of his body while kicking his legs out at Deputy DeMartini and the other involved deputies. Deputy DeMartini said he attempted to grasp Decedent Okobi’s ankles to try and prevent Okobi from kicking them but was unable hold on to him. Deputy DeMartini described the Taser as being effective in that it took Decedent Okobi to the ground but also said it was ineffective in that it did not gain compliance from Okobi. Deputy DeMartini described Decedent Okobi as having “shrugged it off” regarding the effects of the Taser. Deputy DeMartini noted in his past experience, a normal person not under the influence or having mental health issues generally will comply after a Taser deployment.

Deputy DeMartini said Decedent Okobi was able to get back on his feet and began to run east across El Camino Real when Deputy Wang activated his Taser a second time, which caused Okobi to fall to the ground again. Deputy DeMartini said Decedent Okobi was able to get back up on his feet again after the second activation of the Taser. Deputy DeMartini recalled having seen Deputy Watt with his ASP (collapsible baton) out and fully extended; however, did not believe Deputy Watt ever struck Decedent Okobi with the ASP. Deputy DeMartini said Decedent Okobi began to run east across the lanes of traffic for El Camino Real. Deputy DeMartini said Decedent Okobi was in between he and Deputy Wang but he could see Deputy Wang bring his ASP but did not see if Deputy Wang made any attempt to strike Okobi. Deputy DeMartini said Decedent Okobi was flailing his hands as he advanced toward Deputy Wang. Deputy DeMartini said he was concerned “because of the sheer size of the guy”. Decedent Okobi would be able to grab the ASP and take it from Deputy Wang. Deputy DeMartini said he felt he needed to knock Decedent Okobi to the ground before he could attempt to grab the ASP, so he did a “shoulder check” style tackle on Okobi which caused he, Okobi and Deputy Wang to all fall to the ground together.

Deputy DeMartini said once they were on the ground, he attempted to control Decedent Okobi’s legs, but Okobi kept kicking. Deputy DeMartini described the other involved deputies as attempting to grab Decedent Okobi’s arms to get them behind Okobi’s back so he could be placed in handcuffs. Deputy DeMartini said while they were on the ground struggling to control Decedent Okobi, someone (unknown to him who) deployed pepper spray which struck and blinded some of the other deputies. Deputy DeMartini said they were able get one of Decedent Okobi’s arms behind him and he was able to place a handcuff on one of Okobi’s arms. Due to the size of Decedent Okobi, Deputy DeMartini said they had to utilize a second set of handcuffs linked together before he was able to get Okobi’s other arm handcuffed. Deputy DeMartini said Decedent Okobi was “being vocal” when they were struggling to place him in handcuffs but could not recall what Okobi was saying.

Deputy DeMartini said once Decedent Okobi was handcuffed, they rolled Okobi onto his side and ultimately brought him up into a seated position with his back resting against Deputy Watt’s legs. Deputy DeMartini said he later relieved Deputy Watt’s position so Deputy Watt could flush his



eyes with water due to the pepper spray exposure. Deputy DeMartini said Decedent Okobi was not alert, but he could hear Okobi breathing while he supported him upright. Deputy DeMartini said Decedent Okobi's head was facing downward so he lifted Okobi's head back to aid his breathing and checked him for a pulse at his carotid artery. Deputy DeMartini said he felt a pulse but said due to the fact he had just been struggling with Okobi, he was no longer certain if he felt Okobi's pulse or his own pulse. Deputy DeMartini said he was relieved by another unknown deputy and was directed by Sergeant Weidner to go take photographs of the scene and obtain statements from witnesses. Deputy DeMartini said he was away from Decedent Okobi's location for quite a while and when he returned, he saw Okobi being loaded into an ambulance.

I asked Deputy DeMartini to describe Decedent Okobi's physical appearance to me. Deputy DeMartini described Decedent Okobi as "a large guy" who was approximately 6'3" to 6'4" and weighing more than three hundred (300) pounds. Deputy DeMartini said when he first observed Decedent Okobi, Okobi's eyes were "wide open" and "his pupils were pretty pinned out". I asked Deputy DeMartini if he believed Decedent Okobi was possibly suffering from mental illness or was under the influence of a controlled substance. Deputy DeMartini stated "one or the other or both". Deputy DeMartini also described Decedent Okobi as a "very strong guy". Deputy DeMartini said he did not see Decedent Okobi strike Deputy Wang but did see physical injuries on Deputy Wang's face after Okobi was detained. Deputy DeMartini said he suffered abrasions to both hands, both knees, and his right elbow during the struggle to handcuff Decedent Okobi.

I asked Deputy DeMartini if he felt he could have utilized his CIT training to de-escalate the incident. Deputy DeMartini said he did not believe the techniques he learned from CIT training would have been effective because Decedent Okobi was "agitated to the point where it wouldn't have sunk in. I don't think he would have listened". Deputy DeMartini told me he does not have any formal training in recognizing persons under the influence of a control substance but is generally aware of the signs and symptoms of controlled substance influence based upon his twenty-one (21) years in law enforcement and the many contacts he has had working in the jail and on patrol. I asked Deputy DeMartini if he felt he or the other involved deputies could have backed away from the situation and let Decedent Okobi walk away. Deputy DeMartini said he did not believe they could have let Decedent Okobi go due to his demeanor and the fact he was an on-going danger to himself and others by walking in and out of busy, mid-day traffic on El Camino Real. Deputy DeMartini added his belief Decedent Okobi was a danger to himself and needed to be evaluated for a mental health hold. Deputy DeMartini said Decedent Okobi's size, strength and the fact they had such difficulty in getting him detained and handcuffed indicated Okobi could have possibly caused injury to the deputies and members of the public had Okobi been allowed to get away from them.

**PHOTOGRAPHS OF INVOLVED DEPUTIES:**

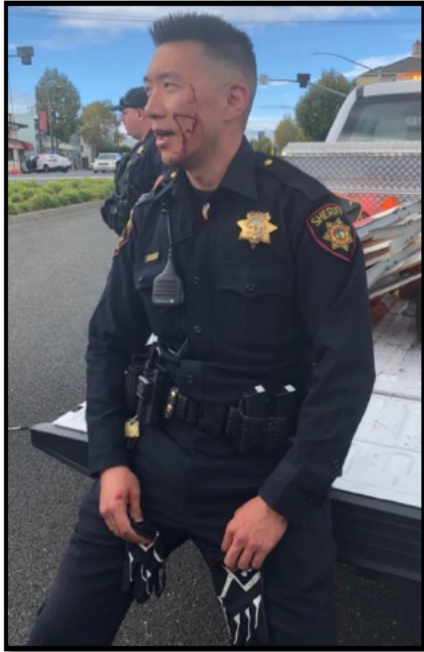

**Deputy Joshua Wang**

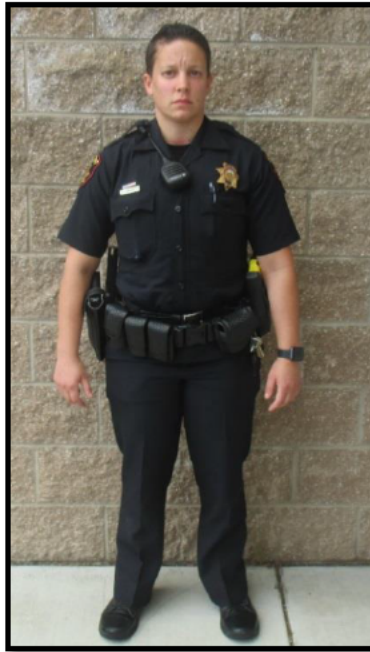

**Deputy Alyssa Lorenzatti**



**Deputy John DeMartini**



**Deputy Bryan Watt**

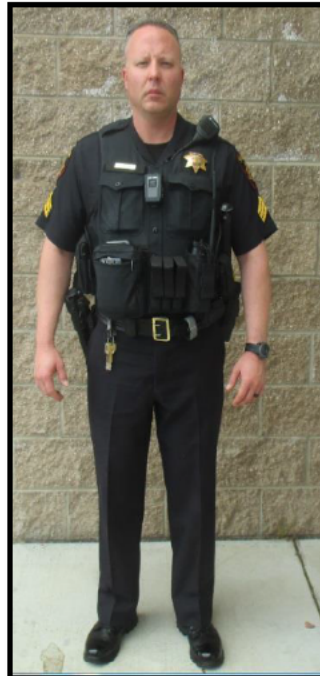

**Sergeant David Weidner**

### **REVIEW OF MOBILE AUDIO VIDEO (MAV):**

Inspector Kevin Raffaelli reviewed and summarized the video footage captured by the Mobile Audio Video (MAV) systems from the patrol vehicles of each of the five (5) deputies involved in the attempts to take Decedent Chinedu Okobi into custody on October 3, 2018.

#### **MAV for San Mateo County Sheriff's Office Vehicle #10 (Deputy Joshua Wang)**

- 13:00:00 Deputy Wang approached the intersection of Capuchino Drive driving south on El Camino Real. Decedent Okobi is visible as he walked from the northwest corner of Millwood Drive, east across El Camino Real. The pedestrian crosswalk for Millwood Drive is located on the south side of the intersection and not where Decedent Okobi entered El Camino Real. The traffic signal for southbound El Camino Real at Millwood Drive was visible as Decedent Okobi crossed and showed it was green. Decedent Okobi caused a vehicle travelling southbound to slow but it continued through the intersection past Okobi. Decedent Okobi continued eastbound and walked into lane #2 as the traffic light for southbound El Camino changed to yellow and then red as Okobi approached the center median.
- 13:00:25 Deputy Wang did a U-turn as Decedent Okobi walked northeast at an angle across the northbound traffic lanes of El Camino Real.
- 13:00:31 Deputy Wang pulled alongside of Decedent Okobi near San Juan Avenue and El Camino Real. Deputy Wang is heard stating "Hey, hold up a minute" and "Hold up a minute". Decedent Okobi is not in view of the MAV camera.
- 13:00:59: Deputy Wang's MAV showed Decedent Okobi as he walked northbound in the center median. Deputy Wang contacted County Communications utilizing his call sign of "Boy-62".
- 13:01:09 Decedent Okobi is shown having reached the western sidewalk as southbound traffic approaches the area.
- 13:01:10 Deputy Wang advised County Communications "Can you put me on a ped stop at ECR and Capuchino and can you roll me one more unit please".
- 13:01:26 Deputy Wang advised County Communications "and if you could send them Code 3, he's running on ECR into traffic". Decedent Okobi is seen moving south in the left turn lane for northbound traffic. Decedent Okobi was seen looking toward Deputy Wang's vehicle before he turned and walked toward the east sidewalk.
- 13:01:47 Decedent Okobi is shown running northbound at El Camino Real and Capuchino where he crossed southbound lanes of traffic. Several vehicles southbound on El Camino Real stopped to avoid striking Okobi.
- 13:01:55 Deputy Wang advised County Communications "he's on foot, I am just paralleling him on ECR, he's a BMA about 6 feet tall, 220 pounds wearing a blue and black stripe shirt, still walking in traffic".



13:02:50 Deputy Wang exited his vehicle, a muffled voice possibly belonging to Decedent Okobi stated “what”, and Deputy Wang said, “let’s come over here and talk on the sidewalk”.

13:03:00 Deputy Wang got back into his car and accelerated north on El Camino Real, Deputy Wang advised County Communications “still walking northbound ECR”

13:03:45 Two additional Sheriff’s Department vehicles are shown as they cross from the northbound lanes into the southbound lanes of El Camino Real toward Decedent Okobi.

13:03:49 Decedent Okobi continued to walk south and raised his hands.

13:03:51 Deputy Alyssa Lorenzatti approached Decedent Okobi from the south, pointed toward Decedent Okobi and stated, “Get down on the ground”. Decedent Okobi continued to walk southbound past Deputy Lorenzatti as Deputy Lorenzatti reached to grab Decedent Okobi’s left hand. Decedent Okobi moved his hand to avoid her grab attempt.

13:03:57 Deputy Wang and Deputy DeMartini ran to assist Deputy Lorenzatti as Decedent Okobi raised his hands and continued to walk away.

13:04:02 Deputy Lorenzatti grabbed Decedent Okobi’s arm and said, “Stop resisting”. Deputy Wang said, “You are going to get Tased, get on the ground, now!” A struggle then ensued between the deputies and Decedent Okobi. Decedent Okobi can be seen resisting and trying to pull away from the deputies. Decedent Okobi pulled away from Deputy DeMartini who was holding Okobi’s shirt sleeve until Okobi was able to slip out of the shirt and away from Deputy DeMartini’s grasp.

13:04:13 Decedent Okobi turned to run south on El Camino Real when Deputy Wang deployed his Taser at Okobi. Decedent Okobi fell forward on the ground.

13:04:17 Decedent Okobi rolled on his back with his legs and arms extended. Deputy Wang advised County Communications “Give me a Code 33, we have a Taser deployment”. The deputies can be heard telling Decedent Okobi to “roll over on your stomach, now”.

13:04:30 Deputy Wang broadcast on the radio “second Taser deployment” as Decedent Okobi remained on his back and continued to not comply with commands.

13:04:40 Deputy Wang said, “I am going to Tase you again if you do not roll over on your stomach”. Continual commands are heard being given but Decedent Okobi did not comply.

13:04:47. Deputy Wang advised over the radio “Still resisting, third Taser deployed”. Decedent Okobi was given continual commands to roll over without compliance and is seen pulling away from attempts being made to grab Okobi’s arms.

13:05:17 Decedent Okobi was able to get up and turn away from the deputies. Decedent Okobi was possibly Tased again as he is seen falling to the ground. Deputy Watt extended his ASP (collapsible baton) but did not strike Decedent Okobi.

- 13:05:31 Decedent Okobi attempted to get up and then fell to the ground (unknown if the Taser activated). Deputy Wang broadcast over the radio, “Boy 62, can you roll medical”.
- 13:05:35 Decedent Okobi stood up and jogged away from the deputies headed east across El Camino Real. All the deputies and Decedent Okobi left the view of the MAV camera. The Taser can be heard being activated but the louder sound of the Taser activation indicated it was no longer properly connected to Decedent Okobi. Sergeant Weidner is heard telling Deputy Wang to “Turn the Taser off”.

Once the deputies and Decedent Okobi moved out of the view of the MAV camera and further from Deputy Wang’s patrol vehicle, the audio became intermitted and difficult to hear.

#### **MAV for San Mateo County Sheriff’s Office Vehicle #8 (Deputy Alyssa Lorenzatti)**

- 13:03:38 Deputy Lorenzatti arrived on scene as Decedent Okobi was walking on the west sidewalk of El Camino Real. There is no audio outside of the vehicle for Deputy Lorenzatti’s MAV system.
- 13:03:55 Decedent Okobi continued to walk toward Deputy Lorenzatti and raised his hands upward, then put them to his side. Deputy Lorenzatti attempted to grab Decedent Okobi’s left arm but Decedent Okobi pulled away from her.
- 13:03:58 Deputy DeMartini and Deputy Wang ran to assist Deputy Lorenzatti. The deputies attempted to grab Decedent Okobi, but Okobi broke free. Deputy DeMartini held onto Decedent Okobi’s left shirt sleeve, but Okobi was able to shed the shirt and got away from Deputy DeMartini’s grasp.
- 13:04:09 Decedent Okobi began to run away but turned and ran at Deputy Wang while reaching out with his right hand and slapped at the Deputy Wang’s Taser. Deputy Wang deployed his Taser at Decedent Okobi, who took a few steps away from Deputy Wang before he fell to the ground.
- 13:04:21 All parties moved out of the view of the MAV camera.

#### **MAV for San Mateo County Sheriff’s Office Vehicle # 1 (Sergeant David Weidner)**

- 13:04:10 Sergeant Weidner exited his vehicle and ran to assist the deputies as they attempted to detain Decedent Okobi and Okobi pulled away from them. Decedent Okobi began to run away then turned and moved toward Deputy Wang. Deputy Wang had his Taser out and pointed it at Decedent Okobi as Okobi ran toward Deputy Wang. Deputy Wang deployed his Taser at Decedent Okobi as Okobi raised his hand and appeared to reach toward Deputy Wang. Decedent Okobi took a few steps towards Deputy Wang then turned and fell to the ground. Deputy Lorenzatti moved in to grab Decedent Okobi’s right hand. Deputy Lorenzatti was unable to grab Decedent

- Okobi's right hand and moved to grab Decedent Okobi's left hand while Sergeant Weidner and Deputy DeMartini tried to control Decedent Okobi legs. Decedent Okobi was able to break free of Deputy Lorenzatti's hold and kicked his legs at Sergeant Weidner and Deputy DeMartini.
- 13:04:25 Deputy Wang ordered Decedent Okobi to roll over and warned him of another Taser activation. Deputy Wang activated the Taser a second time when Decedent Okobi refused to comply.
- 13:04:33 Decedent Okobi continued to not comply with multiple requests to roll over onto his stomach and kicked out at the deputies with his feet. Deputy Wang activated his Taser for a third time.
- 13:05:48 Sergeant Weidner grabbed Decedent Okobi's left arm and made several attempts to gain Okobi's compliance by telling Okobi they would remove the Taser probes if Okobi rolled over. Decedent Okobi can be heard stating "spread the word of God" and Sergeant Weidner responded by saying "Okay, okay, okay. We'll do that. Roll over on your stomach".
- 13:05:16 Decedent Okobi got to a standing position and Deputy Wang appeared to activate his Taser a fourth time. Decedent Okobi turned away from Deputy Wang and took two (2) steps before he fell to the ground. Decedent Okobi yelled "somebody help me" as the deputies continued to order Okobi to roll onto his stomach. Deputy Watt is shown expanding his ASP (collapsible baton) and holding it as if prepared to strike; however, Deputy Watt is not ever seen using the ASP to strike Decedent Okobi.
- 13:05:24 Decedent Okobi attempted get to his feet but fell to a seated position, then onto his back before sitting up quickly. Decedent Okobi again yelled "somebody help me" and got back to his feet. Decedent Okobi then left the view of the MAV camera with the deputies following him. Deputy Wang can be seen expanding his ASP (collapsible baton).
- 13:04:48 Once Decedent Okobi and the deputies are out of view of the MAV camera, the audio from Sergeant Weidner's body-worn microphone can still be heard. Two (2) more Taser activations are heard but are much louder indicating the Taser is no longer connected to at least one (1) probe rendering it ineffective. Sergeant Weidner can be heard telling Deputy Wang to turn the Taser off during the last activation.
- 13:06:18 Sergeant Weidner told the deputies "stay on top of him, stay on top of him, watch out he's bleeding". Sergeant Weidner continuously told Decedent Okobi to give him his hands. Multiple deputies can be heard yelling in pain and one asked "who did that?" Deputy Watt can be heard stating "I'm out" and Deputy Lorenzatti can be heard saying "I can't see". Sergeant Weidner instructed Deputy Lorenzatti to "stay in this, stay in it".



- 13:07:52 Sergeant Weidner told the deputies to “watch for positional asphyxia”. Sergeant Weidner also made several radio broadcasts which will be summarized in a separate area of this report.
- 13:08:50 Sergeant Weidner told the deputies “watch his breathing”. One of deputies is heard asking “you alright” and stating, “he’s still breathing”.
- 13:09:25 Sergeant Weidner is heard stating “sit him up”.
- 13:10:00: Sergeant Weidner is heard stating “take his pulse”.
- 13:11:38 Sergeant Weidner states, “is he okay, is he okay?” and “check his pulse”.
- 13:13:48 Sergeant Weidner is heard stating “I need you to check his pulse to make sure he is good to go”.
- 13:17:25 One of the medical personnel can be heard stating “we need to go”, Sergeant Weidner is heard telling someone “we need to follow him”.
- 13:17:50 One of the medical personnel is heard stating “We need a monitor on him right now” and Sergeant Weidner repeated the request to an unknown person.

#### **MAV for San Mateo County Sheriff’s Office Vehicle #37 (Deputy Bryan Watt)**

- 13:04:14 Deputy Watt arrives on scene. Decedent Okobi is already on his back on the ground, Deputy Lorenzatti’s patrol vehicle is blocking the MAV view of the incident.

There is no MAV audio and Deputy Watt’s video captures activity of the deputies and Decedent Okobi which was described in the previous section for Sergeant Weidner’s MAV video.

#### **MAV for San Mateo County Sheriff’s Office Vehicle #16 (Deputy John DeMartini)**

- 13:03:48 Deputy DeMartini arrived on scene. Decedent Okobi is seen walking on the west sidewalk of El Camino Real. Decedent Okobi raised his left hand and makes a stop motion toward Deputy DeMartini as Deputy DeMartini stopped his patrol vehicle. Deputy Wang’s vehicle pulled to a stop on southbound El Camino Real.

There is no audio for Deputy DeMartini’s MAV video and no pertinent footage is captured beyond what was summarized above.

#### **MAV for San Mateo County Sheriff’s Office Vehicle # T5 (Sergeant Irfan Zaidi)**

- 13:12:07 Sergeant Zaidi arrives on scene (No audio). The camera view is partially obstructed due to a parked vehicle in front of Sergeant Zaidi’s vehicle. Video captures partial view of Deputies who appeared to be bracing Decedent Okobi in a seated position.

- 13:13:59 AMR arrived on scene and the medics move a gurney and equipment towards Decedent Okobi.
- 13:17:01 Vehicle which blocked video moved out of the field of view. The footage now captured Decedent Okobi's location. Decedent Okobi was in seated position while medical personnel attended to him.
- 13:17:34 Decedent Okobi is laid on his back by medics.
- 13:17:56 A paramedic initiated chest compressions on Decedent Okobi and began life-saving measures.
- 13:28:00 Decedent Okobi was placed on gurney.
- 13:28:14 Decedent Okobi was placed in an ambulance for transportation to the hospital.

### **REVIEW OF CIVILIAN VIDEO FOOTAGE:**

Witness Robert Garrison took a total of six (6) short video clips from inside the Tri Counties Bank (1551 El Camino Real, Millbrae CA) which depicted various portions of the attempts by San Mateo County Sheriff's Deputies to detain Decedent Okobi. The video clips begin after the first deployment of the Taser by Deputy Joshua Wang. The audio portion of these videos only captures commentary by Garrison and other persons inside the bank and not the activity outside involving Decedent Okobi. Inspector Kevin Raffaelli reviewed and summarized the videos by Garrison in a supplemental report. The following is a summary of Inspector Raffaelli's observations from Garrison's video clips.

#### **Video #1 (File Name: IMG 3665):**

Decedent Okobi is shown on the ground, laying on his back in the roadway. Deputy Wang's right arm is seen holding a Taser which has already been deployed. Sergeant Weidner, Deputy Lorenzatti, Deputy DeMartini and Deputy Watt are shown attempting to grab Decedent Okobi's arms and legs. Decedent Okobi is seen resisting the attempts to grab his limbs by swinging his arms and kicking with his legs. **(Total video length: 34 seconds).**

#### **Video #2 (File Name: IMG 3666):**

Decedent Okobi is shown on his back and resisting attempts by the deputies to control his limbs. Decedent Okobi is seen getting back up onto his feet and taking several steps before an apparent Taser activation caused him to fall to the ground. The view of Decedent Okobi on the ground is obstructed by a patrol vehicle between Okobi and the camera. Deputy Watt can be seen taking out and expanding his ASP (collapsible baton) but does not strike Decedent Okobi. The camera is seen being moved to a different window within the bank. Once the camera is back on the activity outside the bank, Decedent Okobi is shown standing and then jogging east across El Camino Real. The camera is moved again to a different window within the bank. Once in the new location, the camera captured footage of Decedent Okobi having turned to face the pursuing deputies and back peddling away from them. Deputy Wang can be seen holding an ASP (collapsible baton) and appeared to attempt a strike to the midsection of Decedent Okobi. Decedent Okobi is seen throwing a punch

with his right hand which connected to the left side of Deputy Wang's face. The group of deputies and Decedent Okobi moved further south and out of the primary view of Witness Garrison's camera. Once Witness Garrison is able to pan the camera further south, Decedent Okobi can be seen on the ground and the involved deputies are seen attempting to hold Okobi down on the ground. **(Total video length: 74 seconds).**

**Video #3 (File Name: IMG 3667):**

Decedent Okobi is shown on the ground in the northbound lanes of El Camino Real. The involved deputies are shown continuing to struggle with Decedent Okobi. Vehicular traffic from the El Camino can be seen driving past and limited the view of the activity in this clip. **(Total video length: 26 seconds).**

**Video #4 (File Name: IMG 3668):**

Decedent Okobi remained on the ground with the involved deputies attempting to handcuff Okobi. By the end of this segment, the deputies appear to have gotten Decedent Okobi handcuffed. **(Total video length: 49 seconds).**

**Video #5 (File Name: IMG 3669):**

Decedent Okobi is shown being moved to a seated position. Sergeant Weidner is seen bending down and checking Okobi's face several times during the clip. **(Total video length: 52 seconds).**

**Video #6 (File Name: IMG 3670):**

Decedent Okobi is shown in a seated position and paramedics have arrived on the scene and are shown tending to Okobi. **(Total video length: 9 seconds).**

**Timeline of Events:**

Inspector Kevin Raffaelli completed an estimated incident timeline showing the elapsed time of the significant events which occurred during the incident in October 3, 2018. Inspector Raffaelli compiled this timeline via his review of the available video footage and dispatch radio traffic. Inspector Raffaelli determined the first Taser activation occurred approximately 4 minutes and 12 seconds (4:12) after Decedent Chinedu Okobi can first be seen crossing El Camino Real against a red traffic signal. The third and final fully effective five (5) second activation of the Taser occurred twenty-eight (28) seconds after the first activation. The fourth activation which was likely ineffective then occurred thirty-seven (37) seconds after Taser activation number three (3). Deputy Wang made the first request for paramedics to respond to the scene fourteen (14) seconds after activation number four (4). Decedent Okobi ran across El Camino Real approximately 5 minutes and 34 seconds (5:34) after the original jaywalking incident and is brought to the ground by the deputies twenty-five (25) seconds later. Decedent Okobi appeared to have ultimately been placed in handcuffs between 1 minute and 31 seconds (1:31) and 1 minute and 53 seconds (1:53) after being taken to the ground. Sergeant David Weidner makes a request for paramedics to respond



approximately 2 minutes and 45 seconds (2:45) after Taser activation number four (4). Decedent Okobi is placed in a seated position somewhere between 1 minutes and 37 seconds (1:37) and 1 minute and 55 seconds (1:55) after being successfully handcuffed. The first group of paramedics/fire fighters arrived on scene 7 minutes and 12 seconds (7:12) after Taser activation number (4) and the first ambulance arrived on scene twenty-nine (29) seconds later. Paramedics initiated CPR on Decedent Okobi 3 minutes and 57 seconds (3:57) after the arrival of the first ambulance and 12 minutes and 39 seconds after Taser activation number four (4). If Taser activation number three (3) was the final effective activation, Decedent Okobi appeared to go into cardiac arrest approximately 13 minutes and 16 seconds (13:16) later.

For further details regarding the timeline of events, Inspector Raffaelli's timeline is attached to this report as "Appendix A"

**BACKGROUND OF CHINEDU OKOBI:**



*Chinedu Valentine Okobi (California Driver's License Photograph as of 12/29/2017)*

Inspector James Haggarty conducted an investigation into the background of Decedent Chinedu Okobi [REDACTED]

[REDACTED]

[REDACTED]

[REDACTED]

[Redacted text block]

[Redacted text block]

[Redacted text block]

[Redacted text block]

[Redacted text block]

[Redacted text block]

[REDACTED]

[REDACTED]

[REDACTED]

[REDACTED]

**STATEMENTS FROM FAMILY MEMBERS OF DECEDENT CHINEDU OKOBI:**

**Statement of Telema Okobi (Father of Decedent Chinedu Okobi):**

On November 7, 2018, Senior Inspector Rich Maher spoke via telephone with Telema Okobi. Telema Okobi had previously contacted District Attorney Steve Wagstaffe and identified himself as the father of Decedent Chinedu Okobi and stated he wished to discuss the investigation as well as talk about his son. Telema Okobi told Senior Inspector Maher he had called the District



Attorney's Office to "share his heart" and expressed frustration with efforts being made to "politicize the death" of his son. Telema Okobi stated he loved Decedent Okobi and had a "wonderful" relationship with him.

Telema Okobi told Senior Inspector Maher he had spoken with Decedent Okobi two (2) days before his death. Telema Okobi stated Decedent Okobi was in Texas at the time of the call and was discussing returning to the Bay Area to "get into the corporate world". Telema Okobi said he did not know Decedent Okobi was back in the Bay Area until he got a phone call from Decedent Okobi's mother informing him of Decedent Okobi's death. Telema Okobi acknowledged that Decedent Okobi had mental health issues for which he took medication; however, he did not know the names of the medications. Telema Okobi stated Decedent Okobi rejected the fact he was incapable of caring for himself and Telema Okobi felt the administration of Decedent Okobi's medications should have been supervised by his mother or someone else. Telema Okobi said Decedent Okobi would at times cease taking his medications and Decedent Okobi's sister would call Telema Okobi to have him contact his son and encourage him to take his medications.

Telema Okobi told Senior Inspector Maher "we have a responsibility as parents. Ahh, I felt that, ahh, when they expect the law enforcement to read the mind of somebody you don't know; you see a 6 foot 3 guy with 300 pounds, who is my son. I mean, going in and out of traffic, I mean you don't read the mind you just do everything, you don't want anybody to become a public charge. If the mother and I know that he has any mental problems, we should I mean, we should make sure he is in a place, ahh place, safe place, he is a brilliant son." Senior Inspector Maher asked Telema Okobi if Decedent Okobi had any diagnosed physical health problems and Telema Okobi said he did not and added, "He is ... all American; huge, I mean handsome, strong. I mean if I was a policeman; I'll tell you. If that mass of humanity comes towards me. It was a nightmare, I mean as a nightmare, I mean he's well built."

Telema Okobi said he though Decedent Okobi had previous contact with law enforcement and said Decedent Okobi was once "in custody" in Redwood City for "mental problems." Telema Okobi did not share any details but suggested the information was available.

**Statement of Ebele Okobi (Sister of Decedent Chinedu Okobi):**

On November 16, 2018, Inspector James Haggarty spoke with Decedent Okobi's sister, Ebele Okobi at the District Attorney's Office. Ebele Okobi was present with other members of the Okobi family and the family's retained attorney, John Burriss and Ebele Okobi acted as the primary spokesperson for the family during Inspector Haggarty's questions regarding Decedent Okobi's background. Ebele Okobi said Decedent Okobi's first known display of mental illness by Decedent Okobi occurred while attending Morehouse University and resulted in Okobi being hospitalized in Atlanta. Ebele Okobi said her brother struggled to have his mental illness properly diagnosed for many years, but once he was properly medicated, Decedent Okobi stopped "hearing voices" in

his head. Ebele Okobi said Decedent Okobi failed to attend their family holiday gathering in December of 2017 which led her to suspect her brother was no longer taking his medications. Ebele Okobi said she had infrequent communications with Decedent Okobi after December of 2017. Ebele Okobi described Decedent Okobi as being fearful of law enforcement and afraid of getting into trouble. Ebele Okobi said her brother's fears of law enforcement were a natural consequence of his being a large statured African-American male living in the United States.

**SUMMARY OF TRAINING FOR INVOLVED DEPUTIES:**

On November 2, 2018 Senior Inspector Bill Massey obtained letters from the San Mateo County Sheriff's Office detailing the training records for Deputy Joshua Wang, Deputy Alyssa Lorenzatti, Sergeant David Weidner, Deputy Bryan Watt and Deputy John DeMartini. Senior Inspector Massey isolated the pertinent areas of the individual training records, which are summarized below:

**Deputy Joshua Wang**

**Training attended by Deputy Wang while with the San Mateo County Sheriff's Office:**

July 13, 2018	Electronic Weapons Training	6 Hours
March 23, 2018	Bias Based Policing Training	2 Hours

**Training attended by Deputy Wang while with the San Francisco Police Department:**

October 13, 2017	Field Training Officer Training	40 Hours
September 28, 2017	Crisis Intervention Training (CIT)	40 Hours
September 13, 2018	Tactical Lifesaver Training	8 Hours
April 22, 2017	Treat Assessment/De-escalation Strategies Training	10 Hours
March 24, 2014	Critical Incidents for Patrol Training	2 Hours

**Deputy Alyssa Lorenzatti**

**Training attended by Deputy Lorenzatti while with the San Mateo County Sheriff's Office:**

April 18, 2018	Firearms/ Tactical Rifle Training	24 hours
January 31, 2018	Drug Recognition Expert Update Training	8 hours
November 16, 2017	Crisis Intervention Training (CIT)	38 hours
November 10, 2017	Special Weapons and Tactics Training	80 hours
October 19, 2017	Electronic Weapons Training	4 hours
June 1, 2017	Arrest and Control Tactics Training	4 hours
April 3, 2017	Tactical Communications Training	2 hours
March 6, 2017	Electronic Weapons Training	4 hours
January 24, 2017	Firearm Training	4 hours

**Training attended by Deputy Lorenzatti while with the California Highway Patrol:**

May 28, 2016	Tactical Communications Training	2 hours
April 21, 2016	Firearm Training	4 hours
November 20, 2015	Drug Recognition Expert Update Training	8 hours
November 19, 2015	Tactical Communications Training	2 hours
October 22, 2015	Arrest and Control Tactics Training	4 hours
June 22, 2015	Firearm Training	4 hours
October 30, 2014	Drug Recognition Expert Training	72 hours
May 15, 2014	Firearm Training	4 hours
April 24, 2014	Crisis Intervention Training (CIT)	8 hours
May 10, 2013	Critical Incidents for Patrol Training	2 hours

**Sergeant David Weidner**

June 1, 2018	Firearm/ Tactical Firearm Instructor Training	40 hours
March 14, 2018	Use of Force and Driving Simulator	8 hours
November 7, 2017	Tactical Communication Training	2 hours
July 12, 2017	Chemical Agent Instructor Training	24 hours
March 17, 2017	Less Lethal Weapons Instructor Training	24 hours
February 24, 2017	Arrest Control Tactics Training	8 hours
February 3, 2017	Supervisory Course	80 hours
January 14, 2017	Firearm Training	4 hours
May 18, 2016	Firearm Instructor Update Training	24 hours
February 27, 2015	Academy Instructor Certification Training Course	40 hours
May 22, 2014	Patrol Operations/ Field Leadership Training	72 hours
May 16, 2014	Officer Safety and Field Tactics Update Training	40 hours
January 28, 2014	Less Lethal Weapons Instructor Training	16 hours
December 16, 2013	Tactical Communication Training	2 hours
November 18, 2013	Force Options Simulator Training	4 hours
June 11, 2013	Arrest Control Tactics Training	4 hours
August 14, 2012	Marking Cartridge Scenario Safety Officer Training	16 hours
June 12, 2012	Arrest Control Tactics Training	8 hours
February 21, 2012	Tactical Communication Training	2 hours



December 16, 2011	Firearms/ Tactical Rifle Training	32 hours
November 8, 2011	Electronic Weapons Training	2 hours
June 6, 2011	Firearm Training	8 hours
April 6, 2011	Active Shooter Instructor Training	24 hours
October 20, 2010	Arrest Control Tactics Training	4 hours
March 5, 2010	Officer Safety and Field Tactics	40 hours
January 20, 2010	Racial Profiling Update Training	2 hours
January 20, 2010	Tactical Communication Training	2 hours
January 20, 2010	Firearm Training	4 hours
November 7, 2008	Firearm Instructor Training	80 hours
October 23, 2008	Crisis Intervention Training (CIT)	8 hours
August 1, 2008	Electronic Weapons Training	4 hours
November 15, 2007	Arrest Control Tactics Training	8 hours
November 1, 2007	Crisis Intervention Training (CIT)	38 hours
February 7, 2003	Racial Profiling Training	5 hours
August 15, 2002	Cultural Diversity Training	8 hours
May 24, 1993	Arrest and Firearms Training	64 hours

**Deputy Bryan Watt**

October 20, 2017	Electronic Weapons Training	4 hours
March 24, 2017	Field Training Officer Update Training	24 hours
March 18, 2017	Tactical Communication Training	2 hours
January 14, 2017	Firearm Training	4 hours
August 16, 2016	Firearms/ Tactical Rifle Training	24 hours
April 18, 2016	Arrest and Control Tactics Training	4 hours
August 23, 2015	Tactical Communication Training	2 hours
July 29, 2015	Homelessness and Policing A Collaborative Approach Training	2 hours
April 24, 2015	Bias Based Policing	2 hours
March 20, 2015	Firearm Training	4 hours
January 19, 2015	Surviving Deadly Assaults Training	2 hours
May 27, 2014	Arrest and Control Tactics Training	4 hours
January 10, 2014	Tactical Communication Training	2 hours
December 4, 2013	Use of Force and Driving Simulator	8 hours
May 22, 2013	Patrol Operations/ Field Leadership Training	72 hours
September 20, 2012	Arrest and Control Tactics Training	8 hours
December 27, 2012	Tactical Communication Training	2 hours
December 13, 2011	Electronic Weapons Training	2 hours

June 6, 2011	Firearm Training	8 hours
June 25, 2010	Field Training Officer Training	40 hours
December 16, 2009	Racial Profiling Update Training	2 hours
December 16, 2009	Tactical Communication Training	2 hours
October 1, 2009	Crisis Intervention Training (CIT)	38 hours
November 12, 2008	Crisis Intervention Training (CIT)	8 hours
June 16, 2008	Electronic Weapons Training	4 hours
February 7, 2003	Racial Profiling Training	5 hours
July 21, 2000	Tactical Response to School and Community Violence Training	40 hours
September 9, 1999	Expandable Baton Training	4 hours
May 26, 1995	Arrest and Firearms Training	40 hours

### **Deputy John DeMartini**

#### **Training attended by Deputy DeMartini while with the San Mateo County Sheriff's Office:**

April 12, 2018	Crisis Intervention Training (CIT)	38 hours
February 23, 2018	Tactical Communication Training	2 hours
March 31, 2017	Bias Based Policing Training	2 hours
March 31, 2017	Arrest and Control Tactics Training	4 hours
February 17, 2017	Firearm Training	4 hours
December 23, 2016	Tactical Communication Training	2 hours
May 25, 2016	Arrest and Control Tactics Training	4 hours
March 18, 2015	Firearm Training	4 hours
December 16, 2014	Tactical Communication Training	2 hours
September 30, 2014	Firearm Training	4 hours
September 24, 2014	Firearms/ Tactical Rifle Training	24 hours
September 16, 2014	Arrest and Control Tactics Training	8 hours
December 4, 2012	Firearm Training	4 hours
October 26, 2010	Tactical Communication Training	2 hours
August 10, 2010	Arrest and Control Tactics Training	8 hours
January 20, 2010	Racial Profiling Update Training	2 hours
January 20, 2010	Tactical Communication Training	2 hours
July 14, 2008	Electronic Weapons Training	4 hours
January 30, 2003	Racial Profiling Training	5 hours
September 6, 2002	Expandable Baton Training	4 hours
August 20, 2002	Cultural Diversity Training	4 hours

#### **Training attended by Deputy DeMartini while with the San Francisco Sheriff's Department:**

July 23, 2002	Use of Force and Driving Simulator	8 hours
April 17, 2001	Art of Verbal Control Training	8 hours

**SUMMARY OF PERSONNEL RECORDS FOR INVOLVED DEPUTIES:**

On October 5, 2018, Senior Inspector Bill Massey drafted a letter to San Mateo County Sheriff Carlos Bolanos requesting to review the personnel files of Sergeant David Weidner, Deputy Joshua Wang, Deputy Bryan Watt, Deputy Alyssa Lorenzatti, and Deputy John DeMartini pursuant to California Penal Code Section 832.7(a). Senior Inspector Massey conducted a review of the personnel files of five (5) involved Sheriff’s Deputies. The summary of his file reviews are as follows:

**Personnel File Review - Deputy Joshua Wang:**

Deputy Wang was hired by the San Mateo County Sheriff’s Office on February 26, 2018 as a Deputy Sheriff Lateral hire. Wang graduated from the Basic Police Academy on May 3, 2013, while employed by the San Francisco Police Department. Joshua Wang was previously employed by the San Francisco Police Department from May 3, 2013 through February 25, 2018. Deputy Wang did not have any performance evaluations in his personnel file to date. Deputy Wang did not have any written commendations, complaints or internal affair investigations in his personnel file.

**Personnel File Review - Sergeant David Weidner:**

Sergeant Weidner was hired by the San Mateo County Sheriff’s Office on July 10, 2000 as a Correctional Officer. Weidner graduated from the Basic Police Academy on August 16, 2002 and was promoted from Correctional Officer to Deputy Sheriff. David Weidner was promoted to the rank of Sheriff’s Sergeant on October 23, 2016. All of David Weidner’s performance evaluations reflected overall marks of meets or exceeds expectations and/or standards. Sergeant David Weidner has received at least twenty (20) letters of commendation and/or letters of appreciation

[REDACTED]

**Personnel File Review - Deputy Alyssa Lorenzatti**

Deputy Lorenzatti was hired by the San Mateo County Sheriff’s Office on July 31, 2016 as a Deputy Sheriff Lateral hire. Lorenzatti graduated from the Basic Police Academy on October 30, 2013, while employed by the California Highway Patrol. Alyssa Lorenzatti was previously employed by the California Highway Patrol from January 24, 2013 through July 30, 2016. All of Alyssa Lorenzatti’s performance evaluations reflected overall marks of meets or exceeds expectations and/or standards. Deputy Lorenzatti did not have any written commendations, complaints or internal affair investigations in her personnel file.



**Personnel File Review - Deputy John DeMartini**

Deputy DeMartini was hired by the San Mateo County Sheriff's Office on August 6, 2002 as a Deputy Sheriff Lateral hire. DeMartini graduated from the Basic Police Academy on June 4, 1999, while employed by the San Francisco Sheriff's Department. John DeMartini was previously employed by the San Francisco Sheriff's Department from March 16, 1998 through approximately August 5, 2002.

[REDACTED]

[REDACTED] All the remaining performance evaluations for Deputy DeMartini reflected overall marks of meets or exceeds expectations and/or standards. Deputy DeMartini received one (1) letter of appreciation [REDACTED]

[REDACTED]

**Deputy Bryan Watt**

Deputy Watt was hired by the San Mateo County Sheriff's Office on May 15, 1995 as a Correctional Officer. Watt graduated from the Basic Police Academy on July 30, 1999 and was promoted from Correctional Officer to Deputy Sheriff on July 30, 1999. All of Bryan Watt's performance evaluations reflected overall marks of meets or exceeds expectations and/or standards, except for his initial performance evaluation in 1995 as a Correctional Officer which identified report writing deficiencies. Bryan Watt also withdrew from his initial Field Training Officer program in 1999, but subsequently passed the Field Training Officer program at a later date. Deputy Watt has received at least thirteen (13) letters of commendation and/or letters of appreciation [REDACTED]

[REDACTED]

**TASER (AXON) REPORT:**

On October 17, 2018 Senior Inspector Bill Massey met with Sergeant Bob Pronske of the San Mateo County Sheriff's Office for the purposes of downloading the event logs for the five (5) Tasers assigned to Deputy Joshua Wang, Deputy Alyssa Lorenzatti, Deputy Bryan Watt, Deputy John DeMartini, and Sergeant David Weidner. Sergeant Pronske is the Lead Firearm and Taser Instructor for the San Mateo County Sheriff's Office. Sergeant Pronske connected all five (5) Tasers to the Axon Software in Senior Inspector Massey's presence and downloaded the event

logs for each device. Sergeant Pronske provided Senior Inspector Massey with PDF copies of each Taser download report.

Senior Inspector Massey reviewed the contents of each download report for the five (5) Tasers assigned to the involved deputies and noted only the event logs for Deputy Wang's Taser X26P showed the device had been deployed and utilized during the incident on October 3, 2018. The event logs for showed a total of seven (7) activations consistent with having occurred during the events surrounding the attempts to detain Decedent Chinedu Okobi. Utilizing the event logs for Deputy Wang's Taser X26P, Senior Inspector Massey was able to summarize the Taser usage and gaps in activations as follows:

13:08:18	Deployed for 5 seconds, ending at:	13:08:23
	<i>Pause in activity for 9 seconds</i>	
13:08:32	Deployed for 5 seconds, ending at:	13:08:37
	<i>Pause in activity for 9 seconds</i>	
13:08:46	Deployed for 5 seconds, ending at:	13:08:51
	<i>Pause in activity for 28 seconds</i>	
13:09:19	Deployed for 5 seconds, ending at:	13:09:24
	<i>Pause in activity for 7 seconds</i>	
13:09:31	Deployed for 5 seconds, ending at:	13:09:36
	<i>Pause in activity for 5 seconds</i>	
13:09:41	Deployed for 5 seconds, ending at:	13:09:46
	<i>Pause in activity for 6 seconds</i>	
13:09:52	Deployed for 4 seconds, ending at:	13:09:56

The event logs showed Deputy Wang's Taser X26P was placed in "Safe" mode at 13:09:56 which resulted in the ending of the standard five (5) second cycle earlier by one (1) second for a cycle time of four (4) seconds for the seventh and final activation.

Inspector Rick Decker conducted research on the Taser X26P and learned additional information could be gleaned specifically from the X26P model of device. Inspector Decker learned the X26P had the ability to allow a download of the "Pulse Logs" for each activation which would determine whether the device was making a complete circuit for each activation. A completed circuit utilizing

the Taser in the probe deployment mode of utilization is achievable only when both Taser probes are attached to a subject and the intact probe wires are connected between the probes and the Taser.

Inspector Decker obtained the necessary download software from Axon and was able to re-download Deputy Wang's Taser X26P and obtained the "pulse logs" for each of the seven (7) recorded activations of the device. A review of these "pulse logs" showed only activations number one (1) through three (3) were complete five (5) second cycles. This indicated the delivery of electricity sufficient to cause Neuromuscular Incapacitation (NMI) was delivered from Deputy Wang's Taser into the person of Decedent Okobi for five (5) seconds in each of the first three (3) activations of the Taser. The "pulse logs" cannot determine if the effects of NMI were felt by Decedent Okobi, only as to whether the device was functioning properly or not during each activation cycle. The "pulse log" for activation number four (4) showed the device was not making a complete circuit and would not have been delivering electricity to Decedent Okobi for the first three (3) seconds of the five (5) second activation cycle. At just over three (3) seconds into the cycle for activation number four (4), a completed circuit was obtained consistent with electricity being delivered to Decedent Okobi for approximately one (1) second before becoming ineffective again for the final one (1) second of the activation cycle. This indicated one (1) of the wires extending from the Taser X26P to one of the probes in Decedent Okobi's person had likely become partially detached which enabled the current to pass through only for the one (1) second window when the wire was able to make a completed circuit. The "pulse logs" for activations five (5) through seven (7) showed no electricity would have been delivered from the Taser X26P to Decedent Okobi at any point during the final three (3) activation cycles likely due to damaged or detached probe wires, rendering those activation cycles ineffective.

#### **MEDICAL RECORDS REVIEW DEPUTY JOSHUA WANG:**

The treatment records from Mills-Peninsula Hospital for the treatment of Deputy Joshua Wang on October 3, 2018 were obtained from Sutter Health with the consent of Deputy Wang. A review of these records indicated Deputy Wang was treated for a seven (7) cm laceration to the left side of his face, a lateral cervical strain and a right wrist sprain. The facial laceration was anesthetized, irrigated and repaired with five (5) sutures. Deputy Wang was provided antibiotics for the laceration and instructed to take Motrin for his neck pain. No other injuries or complaints of pain were noted in the medical records.

#### **TRAFFIC CONSIDERATIONS FOR EL CAMINO REAL IN MILLBRAE:**

During Inspector Rick Decker's interview with Deputy Joshua Wang on October 4, 2018, Deputy Wang stated his intent in contacting Decedent Chinedu Okobi on October 3, 2018 was to conduct a traffic enforcement stop of Decedent Okobi based upon Deputy Wang having seen crossing El Camino Real at Millwood when Okobi was not permitted to cross. A review of the MAV video footage from Deputy Wang's vehicle did show Decedent Okobi walking eastbound across El Camino Real against a red traffic signal and outside of a designated crossing area north of the



intersection with Millwood Drive. During my interview with Sergeant David Weidner on October 4, 2018, Sergeant Weidner identified the City of Millbrae as having a high rate of pedestrian related traffic accidents and identified the El Camino Real corridor near Millwood Drive as a “high traffic” area.

I spoke with captain Paul Kunkel of the San Mateo County Sheriff’s Office regarding traffic related issues in the City of Millbrae. Captain Kunkel has been assigned as the Commander for the Millbrae Patrol Bureau since September 2018 and told me he has made traffic enforcement and pedestrian safety a point of emphasis with the deputies under his command. Captain Kunkel said traffic related complaints and pedestrian safety on the El Camino Real corridor are the primary area of complaint expressed by the residence of Millbrae. Captain Kunkel said the Millbrae Patrol Bureau, the City of Millbrae and Caltrans have been working to improve pedestrian safety on El Camino Real for the last several years through better engineering, better signage and focused enforcement. Captain Kunkel noted there has been several traffic enforcement details conducted including one which was featured on the KRON 4 segment titled “People Behaving Badly”. Captain Kunkel also told me the city and Caltrans have installed High Intensity Activated Crosswalks (HAWKs) pedestrian crossing beacons at many of the crosswalks on El Camino Real.

I conducted research via San Mateo County Sheriff’s Office records and available media information regarding pedestrian related accidents in the City of Millbrae since the San Mateo County Sheriff’s Office took over police services for the city in 2012. In my research, I noted Millbrae’s current population is approximately 22,500 residents and El Camino Real stretches approximately 1.5 miles through the city. In looking at only pedestrian related accidents having occurred along this 1.5 mile stretch of El Camino Real through Millbrae since 2012, I noted a total of forty-eight (48) pedestrian related traffic accidents reported via the San Mateo County Sheriff’s Office. Of these forty-eight (48) accidents, the primary collision factor in eleven (11) of the accidents was determined to be either jaywalking or pedestrian in the roadway related violations. An additional twenty-eight (28) accidents listed a primary collision factor related to drivers failing to yield to pedestrians in lawful crossing areas. In looking at the reported locations of the forty-eight (48) pedestrian related accidents, I noted fourteen (14) appeared to have occurred within approximately 2000 feet in either direction of the intersection of El Camino Real and Millwood Drive where Decedent Okobi was first observed crossing the roadway against a red traffic signal.

I also reviewed traffic citations issued in the City of Millbrae by members of the San Mateo County Sheriff’s Office for either jaywalking or pedestrian in the roadway related violations. I located twenty (20) citations for those violations since 2012. I also reviewed citations issued by Deputy Joshua Wang over the past three (3) months and found he had issued forty-seven (47) citations between July 3, 2018 and October 3, 2018. Twenty-one (21) of the citations issued by Deputy Wang were for violations with a listed location on the El Camino Real corridor through Millbrae. There were no citations by Deputy Wang for either jaywalking or pedestrian in the roadway related

violations; however, there were two (2) for violating the right of way of pedestrians in crosswalks which occurred on El Camino Real.

**CRIME LABORATORY REPORT SUMMARY (LAB# M18-04432):**

Members of the San Mateo County Sheriff's Office Forensic Laboratory responded to the area of the 1400 block of El Camino Real in Millbrae on October 3, 2018 and processed the crime scene. Pertinent evidence was measured, photographed, and collected and a 3-D scan was completed of the area. The duty belt and agency issued firearm belonging to Deputy Joshua Wang were also provided to the Forensic Laboratory to be examined for the presence of fingerprints and potential DNA in an attempt to corroborate statements made by both Deputy Wang and Sergeant David Weidner regarding Decedent Chinedu Okobi having grabbed Deputy Wang's holstered firearm and/or the outer portion of Deputy Wang's holster. No latent fingerprints were located on the surface of Deputy Wang's firearm nor on any portions of his duty belt. The firearm and duty belt surfaces were swabbed for contact DNA and Criminalist Tan Ho determined a low-level, partial mixture of DNA from at least two (2) individuals were developed. Criminalist Ho determined the low-level mixture of DNA was inconclusive for comparison purposes and thus it could not be determined if Decedent Chinedu Okobi was one (1) of the contributors to the mixture of DNA profiles developed.

**CORONERS REPORT SUMMARY:**

On December 31, 2018 I received the Coroner's Office Report, prepared by Coroner's Investigator Heather Diaz. The report included redacted sections related to Decedent Chinedu Okobi's medical treatment on October 3, 2018 as well as redacted sections related to his previous medical and mental health treatments pursuant to 56.10 of the California Civil Code. The "Conclusion Report" by Coroner's Investigator Diaz included a summary of the attempts by San Mateo County Sheriff's Office personnel to detain Decedent Okobi and noted Okobi was found to be "unresponsive" upon the arrival of paramedics and fire personnel on the scene. It should be noted that this information is contrary to what was seen upon review of the Mobile Audio Video (MAV) footage at the scene and from the statements provided by fire department paramedics who stated they had determined Decedent Okobi had a pulse and was breathing when they arrived on scene to begin treatment.

**PATHOLOGY REPORT SUMMARY:**

On December 31, 2018 I received the final Pathology Report, prepared by Forensic Pathologist Thomas W. Rogers M.D. Doctor Rogers conducted an autopsy of Decedent Chinedu Okobi on October 4, 2018 and listed Okobi's cause of death as "Cardiac arrest following physical exertion, physical restraint, and recent electro-muscular disruption". Doctor Rogers further listed other significant conditions contributing but not related to the immediate cause of death as "Cardiomyopathy".

Doctor Rogers noted that Decedent Okobi's heart was enlarged and noted Okobi's heart weighed 610 grams. The normal weight for a human, male heart is approximately 331 grams on average. Doctor Rogers also noted the presence of "occasional hypertrophied cardiac muscle cell" and "occasional areas of small scarring" present in Decedent Okobi's heart.

Doctor Rogers noted several small abrasions at various locations on Decedent Okobi's body, primarily on Okobi's arms and hands. Petechial hemorrhages were also noted in the conjunctival surface of both orbital areas of the eyes. Doctor Rogers examined Decedent Okobi's neck and determined Okobi's larynx and hyoid bone were intact and noted no abnormalities to the superior horns of the thyroid cartilage. In examining Decedent Okobi's brain, Doctor Rogers noted findings consistent with cerebral swelling, but noted no subdural, subarachnoid hemorrhages or epidural hemorrhages.

**TOXICOLOGY REPORT SUMMARY:**

On December 31, 2018 I received the final toxicology report for the Chinedu, Chinedu Okobi, from Central Valley Toxicology, Inc., #CVT-18-13046. The report noted a complete drug screen of blood taken from Decedent Chinedu Okobi was conducted. The report noted "No common acidic, neutral or basic drugs detected" and "No Ethyl Alcohol detected". These results indicate Decedent Okobi was not under the influence of any controlled substances, alcohol or prescription medication prior to his death.

**DISPOSITION:**

This investigation in its entirety should be forwarded to the San Mateo County District Attorney's Office Executive Management Team for review.



**ESTIMATED INCIDENT TIMELINE (ELAPSED TIMES / TIME BETWEEN TASER ACTIVATIONS)  
OICI Investigation / San Mateo County DA Case # 18-1003-02**

ACTIVITY	Time occurred, based on MAV System	Elapsed time from initial observation	Elapsed time from last "possible" effective Taser activation	Time between each Taser activation
Decedent crosses against the red light as a car passes through the intersection	13:00:00	00:00		
Activates emergency equipment	13:00:20	:20		
First verbal contact with Decedent	13:00:31	:31		
First radio traffic	13:01:10	1:10		
Radio traffic reporting Decedent is evading him	13:01:25	1:25		
Second attempt with verbal contact	13:02:50	2:50		
Arrival of 2 <sup>nd</sup> Deputy who contacts Decedent (time of exiting car)	13:03:48	3:48		
Arriving Deputy attempts to physically stop Decedent ... pulls arm away	13:03:54	3:54		
Deputy first Taser warning issued	13:04:05	4:05		
Other deputies make contact with Decedent ... pulls away, out of shirt	13:04:08	4:08		
First application of Taser (effective)	13:04:12	4:12		0:00 (1 <sup>st</sup> Activation)
Deputy(s) attempt to physically grab Decedent ... pulls away, kicks	13:04:19	4:19		
Second application of Taser (effective)	13:04:27	4:27		0:15 (2 <sup>nd</sup> Activation)
Third application of Taser (this is likely the last effective application)	13:04:40	4:40		0:13 (3 <sup>rd</sup> Activation)
Deputies attempt to physically and verbally direct Decedent to roll over	13:04:50	4:50		
Decedent gets up from ground	13:05:13	5:13		
4 <sup>th</sup> application of Taser (doubtful if Taser is effective) but Decedent falls to ground	13:05:17	5:17	00:00	0:37 (4 <sup>th</sup> Activation)
5 <sup>th</sup> application of Taser (no shock)	13:05:29	5:29	0:12	0:12 (5 <sup>th</sup> Activation)

**ESTIMATED INCIDENT TIMELINE (ELAPSED TIMES / TIME BETWEEN TASER ACTIVATIONS)  
OICI Investigation / San Mateo County DA Case # 18-1003-02**

ACTIVITY (Continued)	Time occurred, based on MAV System	Elapsed time from initial observation	Elapsed time from last "possible" effective Taser activation	Elapsed time from previous Taser activation
Deputy Wang requests medics (precautionary – per policy for Taser use)	13:05:31	5:31	:14	
Decedent gets up from ground	13:05:33	5:33	:16	
Decedent runs across ECR	13:05:34	5:34	:17	
6 <sup>th</sup> application of Taser (no shock)	13:05:41	5:41	:24	0:10 (6 <sup>th</sup> Activation)
7 <sup>th</sup> application of Taser (no shock)	13:05:52	5:52	:35	0:11 (7 <sup>th</sup> Activation)
Decedent arrives behind truck	13:05:54	5:54	:37	
Decedent is brought to the ground	13:05:59	5:59	:42	
Pepper spray is deployed	13:06:27	6:27	1:10	
Decedent is handcuffed (Range of Time)	13:07:30-13:07:52	7:30-7:52	1:59-2:22	
Medics are requested to respond by Sergeant Weidner Code 3	13:08:02	8:02	2:45	
Sergeant Weidner instructs deputies to 'watch his breathing'	13:08:50	8:50	3:33	
Decedent is placed in sitting position	13:09:25	9:25	4:08	
Decedent has vitals checked (movement, breathing or pulse)	13:10:00	10:00	4:29	
Sergeant Weidner instructs deputies to check pulse again	13:11:38	11:38	6:21	
Medics arrive (Fire / Paramedics)	13:13:30	13:30	7:12	
Ambulance arrives (AMR)	13:13:59	13:59	7:41	
Medics place Decedent on his back	13:17:34	17:34	12:17	
CPR is initiated	13:17:56	17:56	12:39	
Decedent is transported	13:30:00	30:00	24:43	



400 COUNTY CENTER, 3RD FLOOR REDWOOD CITY, CA 94063 650-363-4636  
INFORMATIONAL REPORT

Case  
18-1003-02

<b>OFFENSES</b>	<b>Offenses</b>	<b>Description</b>	<b>Fel/Misd</b>	<b>Date Occurred</b>	<b>Time Occurred</b>	<b>Incident #</b>		
	OICI	Officer Involved Critical Incident		10/03/2018	1301			
				<b>Date Reported</b>	<b>Time Reported</b>			
				10/03/2018	1516			
				<b>Related Cases</b>				
			<b>Date Printed</b>	<b>Time Printed</b>	<b>Printed By</b>			
			12/19/2018	09:27:31	80205			
			<b>Latitude</b>	<b>Longitude</b>				
			0.000000	0.000000				
	<b>Location</b>		<b>Beat</b>	<b>Area</b>	<b>Disposition</b>		<b>Dispo Date</b>	
	1400 State Highway 82 Hwy, Millbrae, CA 94030							
	<b>Location Type</b>	<b>Location of Entry</b>	<b>Method of Entry</b>	<b>Point of Entry</b>	<b>Alarm System</b>	<b>Means of Attack (Robbery)</b>		
<b>VICTIM</b>	<b>Victim</b>		<b>Drivers License</b>	<b>Cell Phone</b>	<b>Email</b>			
	<b>Residence Address</b>		<b>Notified of Victim Rights</b>	<b>Residence Phone</b>	<b>DOB</b>	<b>Age</b>	<b>Sex</b>	<b>Race</b>
	<b>Business Name and Address</b>			<b>Business Phone</b>	<b>Height</b>	<b>Wt</b>	<b>Hair</b>	<b>Eyes</b>
<b>Assistance Rendered/Victim Disposition</b>			<b>Transporting Agency</b>	<b>Means of Attack (Assaults)</b>				
<b>Description of Injuries</b>			<b>Other Information</b>					
<b>WITNESS</b>	<b>WITNESS</b>		<b>Drivers License</b>	<b>Cell Phone</b>	<b>Email</b>			
	Baker, Jeffrey							
	<b>Residence Address</b>		<b>Notified of Victim Rights</b>	<b>Residence Phone</b>	<b>DOB</b>	<b>Age</b>	<b>Sex</b>	<b>Race</b>
						M		
<b>Business Name and Address</b>			<b>Business Phone</b>	<b>Height</b>	<b>Wt</b>	<b>Hair</b>	<b>Eyes</b>	
Central County Fire Department, 511 Magnolia Av, Burlingame								
<b>SUSPECT</b>	<b>Suspect Name</b>			<b>Action Taken</b>	<b>Charges</b>			
	<b>Residence Address</b>			<b>Residence Phone</b>	<b>DOB</b>	<b>Age</b>	<b>Sex</b>	<b>Race</b>
	<b>Business Name and Address</b>			<b>Business Phone</b>	<b>Height</b>	<b>Wt</b>	<b>Hair</b>	<b>Eyes</b>
<b>Identifying Features</b>			<b>Cell Phone</b>	<b>Drivers License</b>	<b>Arrest Number</b>			
<b>Aliases</b>			<b>Val Damaged</b>					
<b>VEHICLES</b>	<b>Status</b>	<b>Vehicle Make and Model</b>		<b>License/State</b>	<b>VIN</b>			
<b>INSPS</b>	<b>Prepared By</b>		<b>Date</b>	<b>Assisted By</b>		<b>Approved By</b>		<b>Date</b>
	80205 - Draper, Jamie		10/03/2018	80213 - Suzuki, Eric				
	<b>Routed To</b>	<b>Date</b>	<b>Routed To</b>	<b>Date</b>	<b>Notes</b>			

**CONTROLLED DOCUMENT**





**INFORMATIONAL REPORT**

<b>WITNESS</b>	WITNESS Barboza, Dennis Joseph	Drivers License [REDACTED]	Cell Phone [REDACTED]	Email			
	Residence Address [REDACTED]	Residence Phone [REDACTED]	DOB [REDACTED]	Age 62	Sex M	Race W	
	Business Name and Address	Business Phone	Height 5'8"	Wt 185	Hair BLK	Eyes BRN	
<b>WITNESS</b>	WITNESS Basurto, Nicole Stephanie	Drivers License [REDACTED]	Cell Phone [REDACTED]	Email			
	Residence Address [REDACTED]	Residence Phone	DOB [REDACTED]	Age 27	Sex F	Race H	
	Business Name and Address Millbrae Dental, 88 Capuchino Dr, Millbrae, CA 94030	Business Phone 650-583-5880	Height 5'2"	Wt 95	Hair BRO	Eyes BRN	
<b>WITNESS</b>	WITNESS Brube, Sean	Drivers License	Cell Phone [REDACTED]	Email			
	Residence Address [REDACTED]	Residence Phone	DOB [REDACTED]	Age 43	Sex M	Race	
	Business Name and Address San Bruno Fire Department, 555 El Camino Real, San Bruno	Business Phone	Height	Wt	Hair	Eyes	
<b>WITNESS</b>	WITNESS Cafferata, Emil	Drivers License	Cell Phone [REDACTED]	Email			
	Residence Address [REDACTED]	Residence Phone	DOB	Age	Sex M	Race	
	Business Name and Address	Business Phone	Height	Wt	Hair	Eyes	
<b>WITNESS</b>	WITNESS Chin, Susan Hung Vi	Drivers License [REDACTED]	Cell Phone	Email			
	Residence Address [REDACTED]	Residence Phone [REDACTED]	DOB [REDACTED]	Age 71	Sex F	Race A	
	Business Name and Address	Business Phone	Height 5'	Wt 96	Hair BRO	Eyes BRN	
<b>WITNESS</b>	WITNESS Coelhoandrada, Luis	Drivers License [REDACTED]	Cell Phone	Email			
	Residence Address [REDACTED]	Residence Phone [REDACTED]	DOB [REDACTED]	Age 75	Sex M	Race H	
	Business Name and Address	Business Phone	Height 5'6"	Wt 170	Hair BLK	Eyes BLK	
<b>WITNESS</b>	WITNESS Donnelly, Thomas	Drivers License	Cell Phone	Email			
	Residence Address [REDACTED]	Residence Phone [REDACTED]	DOB	Age	Sex M	Race	
	Business Name and Address Central County Fire Department, 511 Magnolia Av, Millbrae	Business Phone	Height	Wt	Hair	Eyes	
<b>WITNESS</b>	WITNESS Ferrer, Gia	Drivers License [REDACTED]	Cell Phone	Email			
	Residence Address [REDACTED]	Residence Phone [REDACTED]	DOB [REDACTED]	Age 37	Sex F	Race H	
	Business Name and Address	Business Phone	Height 5'2"	Wt 200	Hair BRO	Eyes HZL	

**CONTROLLED DOCUMENT**



**INFORMATIONAL REPORT**

<b>WITNESS</b>	WITNESS Garrison, Robert	Drivers License [REDACTED]	Cell Phone [REDACTED]	Email			
	Residence Address [REDACTED]	Residence Phone	DOB [REDACTED]	Age 28	Sex M	Race W	
	Business Name and Address	Business Phone	Height	Wt	Hair	Eyes	
<b>WITNESS</b>	WITNESS Gilbert, Mark	Drivers License [REDACTED]	Cell Phone [REDACTED]	Email mgilbert@kellymoore.com			
	Residence Address [REDACTED]	Residence Phone [REDACTED]	DOB [REDACTED]	Age 62	Sex	Race W	
	Business Name and Address	Business Phone	Height	Wt	Hair	Eyes	
<b>WITNESS</b>	WITNESS Gonzales, Joseph	Drivers License	Cell Phone	Email			
	Residence Address [REDACTED]	Residence Phone [REDACTED]	DOB [REDACTED]	Age 24	Sex	Race	
	Business Name and Address	Business Phone	Height	Wt	Hair	Eyes	
<b>WITNESS</b>	WITNESS Holman, Suzanne	Drivers License	Cell Phone	Email			
	Residence Address [REDACTED]	Residence Phone [REDACTED]	DOB	Age	Sex F	Race	
	Business Name and Address Amr, 1510 Rollins Rd, Burlingame	Business Phone	Height	Wt	Hair	Eyes	
<b>WITNESS</b>	WITNESS Johnson, Mi'trease	Drivers License	Cell Phone	Email			
	Residence Address [REDACTED]	Residence Phone [REDACTED]	DOB	Age	Sex F	Race	
	Business Name and Address	Business Phone	Height	Wt	Hair	Eyes	
<b>WITNESS</b>	WITNESS Jose, Maria Contessa	Drivers License [REDACTED]	Cell Phone	Email			
	Residence Address [REDACTED]	Residence Phone [REDACTED]	DOB [REDACTED]	Age 49	Sex F	Race H	
	Business Name and Address	Business Phone	Height 5'3"	Wt 145	Hair BLK	Eyes BRN	
<b>WITNESS</b>	WITNESS Khalid, Farida N	Drivers License [REDACTED]	Cell Phone	Email			
	Residence Address [REDACTED]	Residence Phone [REDACTED]	DOB [REDACTED]	Age 53	Sex F	Race O	
	Business Name and Address	Business Phone	Height 5'5"	Wt 130	Hair BLK	Eyes BLK	
<b>WITNESS</b>	WITNESS Landeros, Brenda	Drivers License	Cell Phone	Email			
	Residence Address [REDACTED]	Residence Phone [REDACTED]	DOB [REDACTED]	Age 32	Sex F	Race	
	Business Name and Address	Business Phone	Height	Wt	Hair	Eyes	

**CONTROLLED DOCUMENT**



**INFORMATIONAL REPORT**

<b>WITNESS</b>	WITNESS Lau, Renee Haiting	Drivers License [REDACTED] CA	Cell Phone	Email			
	Residence Address [REDACTED]	Residence Phone [REDACTED]	DOB [REDACTED]	Age 25	Sex F	Race F	
	Business Name and Address	Business Phone	Height 5'3"	Wt 140	Hair BRO	Eyes BRN	
<b>WITNESS</b>	WITNESS Martinez, Myra	Drivers License [REDACTED]	Cell Phone	Email			
	Residence Address [REDACTED]	Residence Phone [REDACTED]	DOB [REDACTED]	Age 62	Sex F	Race H	
	Business Name and Address	Business Phone	Height 5'3"	Wt 150	Hair BLK	Eyes BRN	
<b>WITNESS</b>	WITNESS Mazza, Mark	Drivers License	Cell Phone	Email			
	Residence Address [REDACTED]	Residence Phone [REDACTED]	DOB	Age	Sex M	Race	
	Business Name and Address Central County Fire Department, 511 Magnolia Av, Millbrae	Business Phone	Height	Wt	Hair	Eyes	
<b>WITNESS</b>	WITNESS Neily, Paul	Drivers License [REDACTED]	Cell Phone [REDACTED]	Email			
	Residence Address [REDACTED]	Residence Phone [REDACTED]	DOB [REDACTED]	Age 39	Sex M	Race W	
	Business Name and Address	Business Phone	Height 6'	Wt 220	Hair BRO	Eyes BRN	
<b>WITNESS</b>	WITNESS Novelli, David	Drivers License	Cell Phone	Email			
	Residence Address [REDACTED]	Residence Phone [REDACTED]	DOB	Age	Sex M	Race	
	Business Name and Address Central County Fire Department, 511 Magnolia Av, Millbrae	Business Phone	Height	Wt	Hair	Eyes	
<b>WITNESS</b>	WITNESS Okobi, Telema	Drivers License	Cell Phone [REDACTED]	Email			
	Residence Address [REDACTED]	Residence Phone	DOB [REDACTED]	Age 71	Sex M	Race B	
	Business Name and Address	Business Phone	Height	Wt	Hair BLK	Eyes BRN	
<b>WITNESS</b>	WITNESS Palatino, Luzviminda	Drivers License [REDACTED]	Cell Phone	Email			
	Residence Address [REDACTED]	Residence Phone [REDACTED]	DOB [REDACTED]	Age 62	Sex F	Race F	
	Business Name and Address	Business Phone	Height 5'3"	Wt 138	Hair BLK	Eyes BLK	
<b>WITNESS</b>	WITNESS Patel, Kirankumar Gandabhai	Drivers License [REDACTED]	Cell Phone	Email			
	Residence Address [REDACTED]	Residence Phone [REDACTED]	DOB [REDACTED]	Age 30	Sex M	Race	
	Business Name and Address	Business Phone	Height 5'7"	Wt 152	Hair BLK	Eyes BLK	

**CONTROLLED DOCUMENT**

**SAN MATEO COUNTY DISTRICT ATTORNEY'S OFFICE**

400 COUNTY CENTER, 3RD FLOOR REDWOOD CITY, CA 94063 650-363-4636  
**INFORMATIONAL REPORT**

Case  
18-1003-02

<b>WITNESS</b>	WITNESS Paulin, Michael	Drivers License	Cell Phone	Email			
	Residence Address [REDACTED]		Residence Phone [REDACTED]	DOB	Age	Sex M	Race
	Business Name and Address San Bruno Fire Department, 555 El Camino Real, San Bruno		Business Phone	Height	Wt	Hair	Eyes
<b>WITNESS</b>	WITNESS Pham, Patrick	Drivers License	Cell Phone	Email			
	Residence Address [REDACTED]		Residence Phone [REDACTED]	DOB	Age	Sex M	Race
	Business Name and Address Amr, 1510 Rollins Rd, Burlingame		Business Phone	Height	Wt	Hair	Eyes
<b>WITNESS</b>	WITNESS Retanubun, Ferdinand	Drivers License	Cell Phone	Email			
	Residence Address [REDACTED]		Residence Phone [REDACTED]	DOB	Age	Sex M	Race
	Business Name and Address Amr, 1510 Rollins Rd, Burlingame		Business Phone	Height	Wt	Hair	Eyes
<b>WITNESS</b>	WITNESS Richardson, Gabriel	Drivers License	Cell Phone	Email			
	Residence Address [REDACTED]		Residence Phone [REDACTED]	DOB	Age	Sex M	Race
	Business Name and Address San Bruno Fire Department, 555 El Camino Real, San Bruno		Business Phone	Height	Wt	Hair	Eyes
<b>WITNESS</b>	WITNESS Uhland, Forrest	Drivers License	Cell Phone	Email			
	Residence Address [REDACTED]		Residence Phone [REDACTED]	DOB	Age	Sex M	Race
	Business Name and Address AMR#37, 1510 Rollins Rd, Burlingame		Business Phone 888-650-5472	Height	Wt	Hair	Eyes
<b>WITNESS</b>	WITNESS Washington, Maria Dosocorrod	Drivers License [REDACTED]	Cell Phone	Email			
	Residence Address [REDACTED]		Residence Phone [REDACTED]	DOB [REDACTED]	Age 65	Sex F	Race O
	Business Name and Address		Business Phone	Height 5'1"	Wt 140	Hair BRO	Eyes BLK
<b>WITNESS</b>	WITNESS Whiteaker, Jeremy	Drivers License	Cell Phone [REDACTED]	Email			
	Residence Address [REDACTED]		Residence Phone	DOB [REDACTED]	Age 36	Sex M	Race
	Business Name and Address San Bruno Fire Department, 555 El Camino Real, San Bruno		Business Phone	Height	Wt	Hair	Eyes
<b>DECEDENT</b>	DECEDENT Okobi, Chinedu Valentine	Drivers License [REDACTED]	Cell Phone	Email			
	Residence Address [REDACTED]		Residence Phone [REDACTED]	DOB [REDACTED]	Age 36	Sex M	Race B
	Business Name and Address		Business Phone	Height 6'1"	Wt 300	Hair BLK	Eyes BRN

**CONTROLLED DOCUMENT**



**SAN MATEO COUNTY DISTRICT ATTORNEY'S OFFICE**

400 COUNTY CENTER, 3RD FLOOR REDWOOD CITY, CA 94063 650-363-4636

Case  
18-1003-02**INFORMATIONAL REPORT**

<b>INVLD OFC</b>	<b>INVOLVED OFFICER</b> Demartini, John	<b>Drivers License</b>	<b>Cell Phone</b>	<b>Email</b>			
	<b>Residence Address</b> 400 County Center, 3RD Floor, Redwood City, CA 94063		<b>Residence Phone</b> 650-216-7676	<b>DOB</b>	<b>Age</b>	<b>Sex</b> M	<b>Race</b>
	<b>Business Name and Address</b> San Mateo County Sheriff's Office, 400 County Center, 3RD Floor, Redwood City, CA 94063		<b>Business Phone</b> 650-216-7676	<b>Height</b>	<b>Wt</b>	<b>Hair</b>	<b>Eyes</b>
<b>INVLD OFC</b>	<b>INVOLVED OFFICER</b> Lorenzatti, Alyssa	<b>Drivers License</b>	<b>Cell Phone</b>	<b>Email</b>			
	<b>Residence Address</b> 400 County Center, 3RD Floor, Redwood City, CA 94063		<b>Residence Phone</b> 650-216-7676	<b>DOB</b>	<b>Age</b>	<b>Sex</b> F	<b>Race</b>
	<b>Business Name and Address</b> San Mateo County Sheriff's Office, 400 County Center, 3RD Floor, Redwood City, CA 94063		<b>Business Phone</b> 650-216-7676	<b>Height</b>	<b>Wt</b>	<b>Hair</b>	<b>Eyes</b>
<b>INVLD OFC</b>	<b>INVOLVED OFFICER</b> Wang, Joshua	<b>Drivers License</b>	<b>Cell Phone</b>	<b>Email</b>			
	<b>Residence Address</b> 400 County Center, 3RD Floor, Redwood City, CA 94063		<b>Residence Phone</b> 650-216-7676	<b>DOB</b>	<b>Age</b>	<b>Sex</b> M	<b>Race</b>
	<b>Business Name and Address</b> San Mateo County Sheriff's Office, 400 County Center, 3RD Floor, Redwood City, CA 94063		<b>Business Phone</b> 650-216-7676	<b>Height</b>	<b>Wt</b>	<b>Hair</b>	<b>Eyes</b>
<b>INVLD OFC</b>	<b>INVOLVED OFFICER</b> Watt, Bryan	<b>Drivers License</b>	<b>Cell Phone</b>	<b>Email</b>			
	<b>Residence Address</b> 400 County Center, 3RD Floor, Redwood City, CA 94063		<b>Residence Phone</b> 650-216-7676	<b>DOB</b>	<b>Age</b>	<b>Sex</b> M	<b>Race</b>
	<b>Business Name and Address</b> San Mateo County Sheriff Office, 400 County Center, 3RD Floor, Redwood City, CA 94063		<b>Business Phone</b> 650-216-7676	<b>Height</b>	<b>Wt</b>	<b>Hair</b>	<b>Eyes</b>
<b>INVLD OFC</b>	<b>INVOLVED OFFICER</b> Weidner, David	<b>Drivers License</b>	<b>Cell Phone</b>	<b>Email</b>			
	<b>Residence Address</b> 400 County Center, 3RD Floor, Redwood City, CA 94063		<b>Residence Phone</b> 650-216-7676	<b>DOB</b>	<b>Age</b>	<b>Sex</b> M	<b>Race</b>
	<b>Business Name and Address</b> San Mateo County Sheriff's Office, 400 County Center, 3RD Floor, Redwood City, CA 94063		<b>Business Phone</b> 650-216-7676	<b>Height</b>	<b>Wt</b>	<b>Hair</b>	<b>Eyes</b>
<b>OTH/ MENTION</b>	<b>OTHER/MENTIONED</b> Ellena, Richard	<b>Drivers License</b>	<b>Cell Phone</b> [REDACTED]	<b>Email</b> richardellena@tcbk.com			
	<b>Residence Address</b> [REDACTED]		<b>Residence Phone</b> [REDACTED]	<b>DOB</b>	<b>Age</b>	<b>Sex</b>	<b>Race</b>
	<b>Business Name and Address</b>		<b>Business Phone</b>	<b>Height</b>	<b>Wt</b>	<b>Hair</b>	<b>Eyes</b>
<b>WITNESS OFC</b>	<b>WITNESS OFFICER</b> Pronske, Bob	<b>Drivers License</b>	<b>Cell Phone</b>	<b>Email</b>			
	<b>Residence Address</b> San Mateo County Sheriff's Office, Redwood City, CA 94063		<b>Residence Phone</b> 650-216-7676	<b>DOB</b>	<b>Age</b>	<b>Sex</b> M	<b>Race</b>
	<b>Business Name and Address</b> San Mateo County Sheriff's Office, 400 County Center, 3RD Floor, Redwood City, CA 94063		<b>Business Phone</b> 650-216-7676	<b>Height</b>	<b>Wt</b>	<b>Hair</b>	<b>Eyes</b>
<b>WITNESS OFC</b>	<b>WITNESS OFFICER</b> Szerenyi, Szabolcs	<b>Drivers License</b>	<b>Cell Phone</b>	<b>Email</b>			
	<b>Residence Address</b> San Mateo County Sheriff's Office, Redwood City, CA 94063		<b>Residence Phone</b> 650-216-7676	<b>DOB</b>	<b>Age</b>	<b>Sex</b> M	<b>Race</b>
	<b>Business Name and Address</b> San Mateo County Sheriff's Office, 400 County Center, 3RD Floor, Redwood City, CA 94063		<b>Business Phone</b> 650-216-7676	<b>Height</b>	<b>Wt</b>	<b>Hair</b>	<b>Eyes</b>

**CONTROLLED DOCUMENT**



**SAN MATEO COUNTY DISTRICT ATTORNEY'S OFFICE**

400 COUNTY CENTER, 3RD FLOOR REDWOOD CITY, CA 94063 650-363-4636

Case  
18-1003-02

**INFORMATIONAL REPORT**

<b>WITNESS OFC</b>	<b>WITNESS OFFICER</b> Trickett, Jacob	<b>Drivers License</b>	<b>Cell Phone</b>	<b>Email</b> jtrickett@smcgov.org			
	<b>Residence Address</b> San Mateo County Sheriff's Office, Redwood City, CA 94063		<b>Residence Phone</b> 650-216-7676	<b>DOB</b>	<b>Age</b>	<b>Sex</b> M	<b>Race</b> W
	<b>Business Name and Address</b> San Mateo County Sheriff's Office, 400 County Center, 3RD Floor, Redwood City		<b>Business Phone</b> 650-216-7676	<b>Height</b>	<b>Wt</b>	<b>Hair</b>	<b>Eyes</b>

**CONTROLLED DOCUMENT**

**SAN MATEO COUNTY DISTRICT ATTORNEY'S OFFICE**

400 COUNTY CENTER, 3RD FLOOR REDWOOD CITY, CA 94063 650-363-4636

**PROPERTY - INITIAL SCENE**

18-1003-02

<b>ID No.</b>	<b>Status/Disposition</b>	<b>Property Description</b>	<b>Value</b>	<b>Val Recovered</b>	<b>Val Damaged</b>
5	Evidence	1 Black & Yel Axon Taser X26P - TASER-COLLECTED BY SMCO CRIME LAB AT SCENE (X13004A6P)			
8	Evidence/Digital Media	46 - 46 DIGITAL PHOTOGRAPHS FROM THE MPFD UAS/DRONE			
9	Evidence/Digital Media	2 - 2 DIGITAL VIDEOS FROM MPFD UAS/DRONE			
14	Evidence	1 Asp Baton - COLLAPSIBLE ASP BATON BELONGING TO DEPUTY WANG			
15	Evidence	2 Taser Wires - TASER WIRES AND PROBES LOCATED AT INITIAL SCENE AND COLLECTED BY CRIME LAB			
16	Evidence	1 Taser Pieces - TASER DOOR PARTS AND AFIDS COLLECTED AT THE SCENE BY THE CRIME LAB			
17	Evidence	1 Fireball Whiskey Bottle - SMALL PLASTIC WHISKEY BOTTLE (EMPTY) COLLECTED AT TEH SCENE BY THE CRIME LAB			
18	Evidence	1 Beathing Tube - PLASTIC BREATHING TUBE COLLECTED AT THE SCENE BY THE CRIME LAB			
19	Evidence	1 Sunglasses - BLACK SUNGLASSES COLLECTED AT THE SCENE BY THE CRIME LAB			
20	Evidence	1 White Towel - WHITE TOWEL COLLECTED AT THE SCENE BY THE CRIME LAB			
21	Evidence	1 Black & Blue Sweater - BLACK AND BLUE SWEATER COLLECETD AT THE SCENE BY THE CRIME LAB			
48	Evidence	8 Dvd - 8 DVDS OF PHOTOGRAPHS FROM CRIME SCENE			
50	Evidence/Urine-Blood	1 Swabs - SWABS OF BLOOD STAINS ON UNIFORM OF CSO GONZALES (1)			
51	Evidence/Digital Media	1 Dvd - DVD CONTAINING 3D LEICA SCANS FROM SCENE			
52	Evidence/Digital Media	1 Dvd - DVD WITH "TRU SCAN" VERSION OF 3D SCANS FROM SCENE			

**CONTROLLED DOCUMENT**

**SAN MATEO COUNTY DISTRICT ATTORNEY'S OFFICE**

400 COUNTY CENTER, 3RD FLOOR REDWOOD CITY, CA 94063 650-363-4636

**PROPERTY - AUTOPSY**

Page 9

18-1003-02

<b>ID No.</b>	<b>Status/Disposition</b>	<b>Property Description</b>	<b>Value</b>	<b>Val Recovered</b>	<b>Val Damaged</b>
22	Evidence/Digital Media	1 Dvd - DVD WITH PHOTOS FROM AUTOPSY TAKEN BY CRIME LAB			
25	Evidence	1 Blue Sheet - BED SHEET			
26	Evidence	1 White Bed Sheets - BED SHEETS			
27	Evidence	1 Gry Pants			
28	Evidence	1 Blue Shirt			
29	Evidence	1 Pants - GREEN PANTS			
30	Evidence	1 Hand Bag - LEFT HAND BAG			
31	Evidence	1 Hand Bag - RIGHT HAND BAG			
32	Evidence	2 White Socks			
33	Evidence	1 White Plastic Bag			
34	Evidence	2 Bro Shoes			
35	Evidence	1 Blue Pants			
36	Evidence	2 Buccal Swab			
37	Evidence	1 Left Hand Swab			
38	Evidence	1 Right Hand Swab			
39	Evidence	1 Facial Swab			
40	Evidence	1 Taser Probe			
41	Evidence	1 Hair Samples - HAIR SAMPLES FROM SCALP			
42	Evidence	1 Nail Clippings - NAIL CLIPPINGS FROM LEFT HAND			
43	Evidence	1 Nail Clippings - NAIL CLIPPINGS FROM RIGHT HAND			

**CONTROLLED DOCUMENT**



**SAN MATEO COUNTY DISTRICT ATTORNEY'S OFFICE**

400 COUNTY CENTER, 3RD FLOOR REDWOOD CITY, CA 94063 650-363-4636

PROPERTY - SMCO DA'S OFFICE

18-1003-02

ID No.	Status/Disposition	Property Description	Value	Val Recovered	Val Damaged
3	Evidence/Digital Media	10 - 10 DIGITAL PHOTOS OF DEPUTY JOSHUA WANG'S UNIFORM AND EQUIPMENT AT THE SMCO DA'S OFFICE			
4	Evidence/Digital Media	5 - 5 DIGITAL PHOTOS OF SERGEANT WEIDNER'S TASER, TASER 11003 X3/ X13001W86 AT THE SAN MATEO COUNTY DA'S OFFICE.			
10	Evidence/Digital Media	1 Dvd - INTERVIEW WITH SERGEANT DAVID WEIDNER			
11	Evidence	1 Dvd - INTERVIEW OF DEPUTY BRYAN WATT			
12	Evidence/Digital Media	1 Dvd - INTERVIEW OF DEPUTY JOHN DEMARTINI			
13	Evidence/Digital Media	1 Dvd - INTERVIEW OF CSO JOEY GONZALES			
46	Safekeeping	1 Samsung - CELLULAR PHONE BOOKED FOR SAFEKEEPING			
47	Safekeeping	1 Usb Drive			
49	Evidence	3 Paperwork - MISC CORONER'S RECEIPTS AND MED CONSENT FORMS FOR DEP WANG			

**CONTROLLED DOCUMENT**

**SAN MATEO COUNTY DISTRICT ATTORNEY'S OFFICE**

400 COUNTY CENTER, 3RD FLOOR REDWOOD CITY, CA 94063 650-363-4636

PROPERTY - MILLBAE PD SUBSTATION

18-1003-02

ID No.	Status/Disposition	Property Description	Value	Val Recovered	Val Damaged
1	Evidence	1 9MM Black Glock 17 9MM Firearm - WITH (3) 17 ROUND EMPTY MAGAZINES (BFKS476)			
2	Evidence	1 Black - BLACK BASKET WEAVE DUTY BELT WITH MOTOROLA RADIO, PEPPER SPRAY, 2 HANDCUFFS, FLASHLIGHT AND 4 BELT KEEPERS			
44	Safekeeping	1 Gry Backpack - BAG CONTAINING PERSONAL PROPERTY			
45	Safekeeping	1 Blk Bag - BAG CONTAINING PERSONAL PROPERTY			

**CONTROLLED DOCUMENT**



**SAN MATEO COUNTY DISTRICT ATTORNEY'S OFFICE**

400 COUNTY CENTER, 3RD FLOOR REDWOOD CITY, CA 94063 650-363-4636

Property for which no scene was specified

18-1003-02

ID No.	Status/Disposition	Property Description	Value	Val Recovered	Val Damaged
6	Evidence	1 Black & Yel Axon Taser X26P - TASER-COLLECTED FROM DEPUTY LORENZATTI (X13004AD5)			
7	Evidence	1 Black & Yel Axon Taser X26P - TASER-COLLECTED FROM SERGEANT WEIDNER (X13001W86)			
23	Evidence	1 Black & Yel Axon Taser X26 - TASER COLLECTED FROM DEPUTY WATT (X00-380563)			
24	Evidence	1 Black & Yel Axon Taser X26 - TASER-COLLECTED FROM DEPUTY DEMARTINI (X00-564295)			

**CONTROLLED DOCUMENT**



**SAN MATEO COUNTY DISTRICT ATTORNEY'S OFFICE**

400 COUNTY CENTER, 3RD FLOOR REDWOOD CITY, CA 94063 650-363-4636

**SUPPLEMENT 1 - Officer Involved Critical Incident  
Protocol Activation and Response**

**Investigation:**

On October 3, 2018 I was advised of an activation of the Officer-Involved Critical Incident (OICI) Protocol by Senior Inspector Richard Maher. I was advised the protocol activation was being initiated by the San Mateo County Sheriff's Office for an incident which occurred in the City of Millbrae for a use of force incident involving the deployment of a Taser. I was advised subject of the Taser deployment, now identified as Decedent Chinedu Okobi had been pronounced dead at Mills-Peninsula Hospital.

I responded to the command post which had been established in the area of El Camino Real and Millwood Drive, Millbrae. Upon arrival, I met with Senior Inspector Bill Massey as well as Inspectors Eric Suzuki and Greg Giguere. Senior Inspector Massey advised me I would be assigned as the primary investigator for the case, Inspector Suzuki would be assigned as the secondary investigator and Inspector Giguere would be assigned to oversee the crime scene and evidence collection.

We met with San Mateo County Sheriff's Sergeant Jacob Trickett who provided us a walkthrough of the scene as well as a summary of the events which had occurred leading to the activation of the protocol. During Sergeant Trickett's briefing of events, I learned the incident began when Sheriff's Deputy Joshua Wang attempted to contact Decedent Okobi for "jaywalking" across El Camino Real near Millwood Drive. Deputy Wang requested an additional cover unit and advised over the radio that Okobi was refusing to stop for Deputy Wang and was running in and out of traffic on El Camino Real. Sergeant Trickett identified the additional Sheriff's Office personnel who responded to the scene to assist Deputy Wang as being Sergeant Dave Weidner, Deputy Alyssa Lorenzatti, Deputy Bryan Watt and Deputy John DeMartini. Sergeant Trickett said it was his understanding Deputy Wang and the other involved deputies attempted to detain Decedent Okobi; however, Okobi became resistive and combative with the deputies, resulting in at least one (1) Taser deployment which apparently was unsuccessful. Sergeant Trickett told us this occurred in the area near a cross walk along the west curb line of El Camino Real near the intersection of Santa Helena. Sergeant Trickett told us it was his understanding this crosswalk was not the same location Deputy Wang first saw Decedent Okobi "jaywalking". Sergeant Trickett went on to advise us the struggle to detain Okobi, and get him into handcuffs, continued back east across El Camino Real and then south on El Camino Real near Capuchino Drive.

Sergeant Trickett told us the involved deputies were eventually able to get Decedent Okobi to the ground and get him handcuffed in the northbound lanes of El Camino Real. Sergeant Trickett told us Deputy Wang had sustained a laceration to the face and a suspected concussion during the incident and was transported to Mills-Peninsula. Sergeant Trickett stated at an unknown point shortly after being detained, and being worked on at the scene by paramedics, Decedent Okobi appeared to have stopped breathing and suffered a possible cardiac event which required him to also be transported to Mills-Peninsula Hospital where he was later pronounced deceased by medical staff. Sergeant Trickett informed us the remaining involved deputies had been taken to a nearby hotel pending the arrival of their legal representation. Sergeant Trickett informed us each of the involved deputies and the involved sergeant were driving marked Sheriff's Office vehicles which were equipped with Mobile Audio Video (MAV)

**CONTROLLED DOCUMENT**

Prepared By: 80205 DRAPER, JAMIE	Date: 10/23/2018	Approved By: 80240 WARREN, JOHN	Date: 12/19/2018
-------------------------------------	---------------------	------------------------------------	---------------------





**SAN MATEO COUNTY DISTRICT ATTORNEY'S OFFICE**

400 COUNTY CENTER, 3RD FLOOR REDWOOD CITY, CA 94063 650-363-4636

**SUPPLEMENT 1 - Officer Involved Critical Incident  
Protocol Activation and Response**

which should have captured the events. He advised us all of the vehicles were still on the scene except for the vehicle driven by Deputy DeMartini, which was at the Millbrae Police Substation.

Senior Inspector Massey and I met with Sheriff's Lieutenant Frank Dal Porto and Sergeant Jon Sebring with the Sheriff's Office Professional Standards Bureau who informed us the primary way to retrieve the video from the MAV system was to bring the vehicles back to the Millbrae Substation where the videos would automatically upload to the server once the vehicles were in the proximity of the parking lot. Due to the fact the vehicles would need to remain in the crime scene for several hours while Forensic Lab personnel processed the scene, Sergeant Sebring recommended having a member of the Sheriff's Office IT staff respond to the scene and download the video directly from the vehicles on scene so they could be viewed by investigators prior to any interviews with involved deputies or key witnesses. Sheriff's Office IT Technician Johnson Hang responded to the scene and was able to allow me to view the videos on the small in-car display from each of the vehicles still at the scene and was able to retrieve the videos from the vehicles driven by Deputy Lorenzatti and Deputy Watt without issue. Hang was unable to retrieve the videos from the vehicles driven by Deputy Wang and Sergeant Weidner at the scene. The video from Deputy DeMartini's vehicle was already uploaded to the server when his vehicle was brought back to the Millbrae Police Substation. Lieutenant Dal Porto was ultimately able to download the videos from the MAV systems for the vehicles driven by Sergeant Weidner, Deputy Wang and Deputy DeMartini and provided copies to me on October 5, 2018.

While at the Millbrae Police Substation meeting with IT technician Hang, Sergeant Sebring advised me Deputy Watt was in possession of a camera which contained photographs taken at the scene. I met briefly with Deputy Watt and took possession of his assigned camera. Deputy Watt told me he did not personally take the pictures from the scene and told me it was his understanding it had been Deputy Lorenzatti who had used the camera to take pictures at the scene. I then met with Sheriff's Sergeant Szabolcs Szerenyi who provided me two (2) duffle bags and a paper bag which had been in the possession of deceased subject Okobi at the time of the contact. Sergeant Szerenyi advised me these items were brought back to the substation by Sergeant Irfan Zaidi who would document their collection in a report. I turned these duffle bags over to Inspector Greg Giguere to be inventoried.

**Disposition:**

Attach to Original Report

**CONTROLLED DOCUMENT**

<b>Prepared By:</b> 80205 DRAPER, JAMIE	<b>Date:</b> 10/23/2018	<b>Approved By:</b> 80240 WARREN, JOHN	<b>Date:</b> 12/19/2018
--	----------------------------	---	----------------------------



**Investigation:**

On October 5, 2018 at approximately 1200 hours, I was provided information that a “Nicole” (no last name provided) had contacted the San Mateo County District Attorney’s Office, stating that she witnessed the incident in Millbrae from October 3, 2018. Nicole provided a call back phone number.

On October 5, 2018 at approximately 1218 hours, I called Nicole back at the listed number and interviewed her regarding her observations of the incident in Millbrae on October 3<sup>rd</sup>. Nicole provided her last name as Basurto and her complete contact information during the phone interview, so she will be referred to in this supplemental report as Witness Nicole Basurto.

(The phone interview was recorded via digital audio recording.)

At the beginning of the phone call, I told Nicole Basurto that the role of the San Mateo County District Attorney’s Office in critical incidents, such as the one that took place in Millbrae, was to independently investigate the incident and that I was not affiliated with the San Mateo County Sheriff’s Office.

Nicole Basurto asked at the beginning of the interview if I was allowed to answer questions that she may have regarding the incident. Basurto continued by saying that the media reports stated that the involved subject (decedent) died at the hospital and she asked me if that was correct. I explained to Basurto that I would be unable to answer some specific questions and that was a question that I did not feel that I could answer. Basurto stated that the reason she asked me that question was because she did not feel like that was correct (she did not believe the decedent died at the hospital). Basurto stated that she was “*fairly certain that he (the decedent) died on the scene.*” Basurto said that after the subject was “*brought to the ground, police officers tried to sit him up and he was unresponsive.*” Basurto said that she could see that the subject was “*unconscious*” and she could recall the police officers leaving the subject in a “*sitting position, against the legs of an officer.*” Basurto stated that she noticed that the subject’s body was “*completely limp*” at that time.

Nicole Basurto said that she believed the subject was unconscious and she wasn’t certain if his heart had stopped already at that point or if it was about to. Basurto stated that there was a man, whom she believed may have been the owner of the tanning salon in that immediate area, who was “*right there.*” Basurto said that the man brought the officers a bottle or bottles of water and they (the officers) splashed the subject in the face with water and he did not respond. Nicole Basurto stated that a few minutes passed and then paramedics arrived. Basurto said that she went back into her office at that point (ultimately identified as Millbrae Dental located at 88 Capuchino Drive in Millbrae, CA) which Basurto said was maybe half a block or less from the scene. Basurto stated that she continued watching the event through the windows of her office. Basurto said that once paramedics arrived, she was “*sure that*” they started checking the subject for a pulse and she said that one of her co-workers told her that paramedics ripped open the subject’s shirt. Basurto stated that her sister is a nurse and she knows that when paramedics rip open a person’s shirt, that means they are going to “*start compressions because someone isn’t breathing.*”

**CONTROLLED DOCUMENT**

<b>Prepared By:</b> 80202 MASSEY, BILL	<b>Date:</b> 10/05/2018	<b>Approved By:</b> 80240 WARREN, JOHN	<b>Date:</b> 12/18/2018
---	----------------------------	---	----------------------------



Basurto said that she ran back out to the area of the street and continued watching. Basurto stated that paramedics started compressions. Basurto said that paramedics wouldn't start compressions unless someone isn't breathing and Basurto stated the she "strongly believed that he (the subject) had died already." Basurto said that none of the officers performed CPR (cardiopulmonary resuscitation) and she knows that police officers are trained in CPR. Basurto stated that she didn't know if any of the police officers "checked for a pulse" and she said, "I didn't see that, they could have, I didn't see that, to be honest with you." Basurto said that she felt that the officers could have started compressions sooner and they did not need to wait for paramedics to arrive on scene. Basurto stated that she believed the subject's heart stopped either when he was brought to the ground or right before he was brought to the ground.

I explained to Nicole Basurto that I could answer some questions that she may have in general terms. I explained that I was not trying to be evasive with her by not directly answering her questions regarding the timing of the subject's death. Basurto told me that she understood. I explained to Basurto that I wished to ask her some additional questions before I answered some of the general questions for her.

Based upon my questions, Nicole Basurto provided the following additional information:

Basurto stated that she was arriving back to work, following her lunch break and she stated, "It had to be 1:00 o'clock on the dot." Basurto said that she was headed northbound on El Camino Real, towards Capuchino Drive (she was heading back to work at Millbrae Dental Care at 88 Capuchino Drive). Basurto stated that she pulled up to the intersection "where you make the left onto Capuchino Drive." (Identified as the intersection of El Camino Real and Capuchino Drive). Basurto explained that she stopped and she was unable to make the left hand turn onto Capuchino Drive because there were cars headed in the southbound direction on El Camino Real and vehicles heading south were not yielding or allowing her to turn left.

Basurto stated that she "was basically forced to sit there" as she was watching the incident. Basurto said that she pulled forward a bit and began watching after "backup had been called" and she believed that there were approximately five to six officers on scene at that time. Basurto stated that the five to six officers were "kind of trying to talk to him (the subject)." Basurto confirmed that she could not hear the exchange of words or what was really being said, but she could see the body language. Basurto stated that "the man looked a little scared." Basurto said, "To be honest with you, I don't know if he had some type of mental disability or if he was on something, I couldn't really tell, but I knew that he wasn't totally there." Basurto stated, "At that point, it just seemed like they were trying to negotiate with him, talk to him." Basurto said, "When I first arrived, I thought it was the weirdest thing because he voluntarily got on the floor." Basurto continued, "He wasn't on his belly, it was very odd so this is why I'm thinking he may have been on drugs, he was on his back and he kind of just rolled onto the floor and then rolled onto his back and police officers were just kind of watching him and puzzled, and it seemed like they were puzzled." Basurto said that none of the police officers approached the subject and Basurto said, "I don't know what police officers are trained to do in this type of situation, but I just feel

CONTROLLED DOCUMENT

Prepared By: 80202 MASSEY, BILL

Date: 10/05/2018

Approved By: 80240 WARREN, JOHN

Date: 12/18/2018





like it would have made sense to try to make an arrest at that point, he voluntarily was on the floor, granted I don't know what the man was saying... maybe officers could have been thinking he had a weapon and that's why they didn't want to try and arrest him at that point, but it's just my personal take on the situation." Nicole Basurto stated that this was when she arrived and began watching the situation.

Nicole Basurto confirmed that she was stationary in her car when the incident first began and she confirmed that the initial portion started in front of the bank (Tri Counties Bank) on El Camino Real. I confirmed with Basurto that the area in front of the bank was where she was referring to when she talked about the subject voluntarily laying on the ground. Basurto said that there was a median in the middle of the road and the incident first took place "across from the ATM machine" and about ten feet from the median that separates northbound and southbound El Camino Real. Basurto stated that the officers (and the subject) were in the middle of the southbound lanes of El Camino Real. Nicole Basurto estimated that she was approximately fifty feet from where the officers and the subject were. Basurto stated that she was in the opposite lanes (northbound lanes) of traffic, but she was positioned closer to the middle of the street, as she was attempting to turn left onto Capuchino Drive.

Basurto stated that the officers "were trying to calm him (the subject) down" and she described the subject waving his hands in gestures that she believed were consistent with him not wanting to be touched. Basurto described this behavior occurring before she saw the subject laying on the ground voluntarily. Basurto said that she could not hear what the officers were saying to the man but she interpreted their body language as talking with the subject or attempting to calm him down or negotiate with him. Basurto stated that when the subject was on the ground, there was at least one of the officers who was trying to get him up "off the floor." Basurto said that it looks to her as though the subject didn't want the officers touching him.

Basurto then stated, "To be honest, I don't remember if they helped him get on his feet or if he got on his feet on his own, but I do remember him struggling to get on his feet. I don't know why, I don't know if he again was on drugs, I don't know if he couldn't breathe, he wasn't holding his chest in any way so there was no indication that he couldn't breathe, but it just seemed very odd to me, his behavior was very odd. So, he was struggling to kind of get on his feet, and then, again, I don't remember exactly if the officers were successful in getting him off his feet or if he did that himself." Basurto added, "He did get on his feet eventually and he then started to walk away from the officers, so first he was walking backwards, away, backwards, but still facing officers...as soon as he turned his back on the officers, he kind of started trying to, I guess what he felt was running, like run away, but it wasn't running, it wasn't even like a light jog." Basurto continued, "He was like a big heavysset man, so I don't think he was really capable of running very fast, and he started to, as soon as he turned his back on officers, I could hear them yelling 'stop, get on the floor, get on your stomach, get on your stomach', and he didn't listen, he kept kind of running away from them."

CONTROLLED DOCUMENT

Prepared By: 80202 MASSEY, BILL

Date: 10/05/2018

Approved By: 80240 WARREN, JOHN

Date: 12/18/2018





Basurto stated, "So, they were kind of looped around the median, and they started coming, he started coming in the direction towards my car and then, that's when I kind of, I left immediately because I was afraid that this man was going to try to get into my car." Basurto said that she turned left and she rolled her windows down when she first approached the incident to see if she could hear anything. Basurto stated that she could hear the taser "go off at least two times as I was turning left." Basurto said that she turned left onto Capuchino Drive and she parked her car near "the bank" (Tri Counties Bank) and then she explained, "I watched part of it through my driver's side mirror, but at that point, I just had, I had a feeling that something bigger was going to happen, so I got out of my car and I watched from Capuchino Drive."

I clarified with Nicole Basurto the positioning of her car and where she was positioned during portions of the event. Basurto confirmed that she was essentially parked or stopped in traffic northbound on El Camino Real (south of Capuchino Drive) during the portion of the event where the subject was on the ground near the bank until the subject got up and began jogging towards her car. Basurto confirmed that as the subject began jogging towards her car, she was fearful that he may attempt to get into her car, so she moved her car forward and turned left onto Capuchino Drive at that time.

I asked Basurto what she saw when she parked her car on Capuchino Drive and ultimately got out of her vehicle to look. Basurto stated, "So when I got out of my car, oh my gosh." Basurto then said that she wrote "a lot of this down" and she "was trying to remember exactly, to be honest, I think by the time that, you know, I think they had already gotten him on the ground, because I remember he, when he, as he was running away, one of the officers grabbed his baton and started to hit him in the back with the baton." Basurto said, "As soon as that happened, he turned around and he started swinging at the officer and I recall that he did come into contact with the officer and they kind of got into a bit of a scuffle and when that happened, when him and that officer got into that scuffle, the rest of the officers came and that's when he was brought to the ground." Basurto stated, "I'm fairly certain I watched that through my, my um mirror." Basurto said that the officer who swung the baton at the subject's back swung it "at least two, possibly three" times. Basurto clarified that was how many times the officer's baton "could have come into contact with the "suspect." Nicole Basurto stated that when "the suspect turned around and started [swinging], he wasn't necessarily swinging at officers with a closed fist, it just kind of seemed like he was kind of slapping them away, but he did come in contact with the officer, so I'm guessing that's when the rest of the officers decided to, you know, do something and approach the man and obviously at that point, he was being aggressive and violent and attacking one of the officers, so they brought him to the ground."

Basurto stated, "One of the things I feel is important to mention is that when he was on the ground, at this point, I want to say there were six, maybe seven officers around him and they had him held on the floor and I vividly remember one of the officers was hitting him." Basurto said, "I saw this man's hand come up and back down and I don't know, I couldn't see from where I was standing if he was hitting his head or was hitting his stomach, he wouldn't be hitting his feet, I'm assuming, um but, I do recall very

CONTROLLED DOCUMENT

Prepared By:	Date:	Approved By:	Date:
80202 MASSEY, BILL	10/05/2018	80240 WARREN, JOHN	12/18/2018



vividly that one of the officers hit him in what seemed to be his head a number of times and I want to say he hit him anywhere between three and four times and in my perspective, I'm just trying to understand the logic behind hitting him upside whether it was the chest, head, what have you when the suspect was already being pinned down and held down by not one, not two, not three, not four officers, it just didn't make sense to me, that doesn't feel ethically and morally correct to do that."

I clarified with Nicole Basurto where her vantage point was for what she had just described. Basurto estimated that she was approximately one hundred feet away and that she had turned left onto Capuchino Drive. She stated, "I was on Capuchino Drive at this point, outside of my car." I asked Basurto if she took any photos or videos with her cell phone or any other devices. Basurto stated that she did not.

I asked Basurto for clarification on the timing of medical aid rendered to the subject, based upon her initial concerns and statements at the beginning of the phone call. Basurto said that as she walked into her office her boss asked her what was going on. Basurto stated that she told her boss what she had seen and that is the same time that the paramedics arrived. Basurto said, "My co-worker said 'oh, the paramedics are here', so we were watching through the window, so I wasn't at the best vantage point to actually see what the paramedics did upon arriving, but the next thing I know one of my colleagues said they were cutting his shirt open and I knew that was when compressions were going to be started, so I ran back outside and at that point, I knew, he obviously stopped breathing, prior to them arriving because from what it seemed like, that was the first thing they were going to do was immediately start compressions." Basurto added, "That was an indication that the man was no longer breathing. So, I don't know when he stopped breathing but when officers were, so after they had him on the ground, they tried sitting him up, but at that point, his body was completely limp and I could see that he was unresponsive."

Basurto added, "I didn't know if it was because of the tasers of, I don't know what had happened." Basurto stated that she saw paramedics performing CPR within "less than a minute of arriving." I asked Basurto some clarifying questions regarding he claim that she heard a taser during the incident. Basurto stated that the officer that hit the subject with the baton, and got into the scuffle with the subject, prior to when he was brought to the ground, that was the officer that "set the taser off from what I could see." Basurto explained that she believed a taser was deployed twice, based upon the sounds that she heard and the taser(s) were deployed later in the incident. I asked Basurto for clarification on the timing of the taser usage. Basurto said that she wasn't sure if officers used a taser on the subject when he was on the ground near the bank. Basurto stated that the taser(s) were used just before the officers took the subject to the ground. Basurto specifically said that she didn't know if any tasers were used on the subject when he was closer to the bank and the ATM.

I asked Basurto if she saw the taser being used when she parked her car on Capuchino Drive, as that was the point where she said she had driven away, watched part of the incident from her driver's side mirror, and then exited her car. Basurto said, "Oh my gosh, I can't really remember." Basurto stated that she

CONTROLLED DOCUMENT

Prepared By: 80202 MASSEY, BILL

Date: 10/05/2018

Approved By: 80240 WARREN, JOHN

Date: 12/18/2018





was watching part of it through her driver's side mirror and she wasn't sure if she saw the officer hit the subject with the baton through her driver's side mirror or not. Basurto stated, "I want to say yes" that she did see the portion of the event where the officer struck the subject with a baton through her driver's side mirror. Basurto said that was when the officers ran up to him and tackled him to the ground.

Basurto stated that she then walked up to the door of her workplace and kept watching from there. Basurto said that the subject was on the ground at that point. Basurto clarified that the taser(s) was deployed when she was in or near the intersection and in her car. Basurto said that she rolled her vehicle windows down and heard the first taser "go off" when she was still stationary in her vehicle. She heard the second taser "went off" when she was turning left onto Capuchino Drive. Basurto stated that she could hear the taser as she was turning left. I clarified with Basurto that she heard the taser deployments after the subject had gotten up off of the ground and began jogging or running towards her vehicle. Basurto was confident that the same officer who used his baton, and ended up struggling with the subject, was also the same officer who utilized his taser.

I asked Basurto about any other use of force and/or other officers who may have used tasers, batons or other weapons. Basurto stated, "No, I didn't see that and I was actually kind of thankful that I didn't see anyone there with their gun drawn because I didn't want to witness that, that would have been a little bit, more traumatic than what I feel like I already saw." (Basurto became emotional at this point in the interview.)

Basurto stated that she believed some level of excessive force was used when officers took the subject to the ground. Basurto estimated that there were approximately "six, maybe seven officers pinning him down to the ground." Basurto acknowledged that the subject was large by saying, "He was a heavier set man, he was tall, he was a big guy, I could understand why they could have felt the need to have so many officers to hold him down, but I just don't really feel that there was a need to use that many, but that's the way that they decided to handle the situation." Basurto said, "When he (the subject) was already on the ground, like I mentioned, there was an officer that was hitting him, that was clearly punching him, and I just didn't understand the need for that." Basurto added, "I wasn't close enough where I could hear the exchange of words, whatever, but I just didn't feel like, it just didn't feel right."

I asked Nicole Basurto about notes she had written about the incident earlier in the interview. Basurto confirmed that she wrote those notes closer in time to the event. I asked Basurto if she would be willing to share those notes with me. Basurto responded, "Yeah, um, I mean I have them in my car." I explained to Basurto the value in sending those notes along, especially since she acknowledged writing them closer to the actual incident date. Basurto responded, "Yeah, definitely", she would be willing to share those notes with me.

Basurto began our phone call by sharing her belief that the subject died at the scene and not at the hospital, which had been reported by the media. I told Basurto that I could not answer that question, or

CONTROLLED DOCUMENT

Prepared By: 80202 MASSEY, BILL

Date: 10/05/2018

Approved By: 80240 WARREN, JOHN

Date: 12/18/2018



address that specific concern regarding this case, but I could talk about it in general terms. I informed Basurto that in San Mateo County specifically, if a person gets transported from a scene to a hospital, that means that the person is technically still alive or has shown some signs of possible life. I explained that a paramedic on scene has the authority to declare a person deceased and in situations where someone is deceased on scene, paramedics would not transport that person to a hospital.

Basurto provided her personal identifying information to me at this point in the interview. I asked Basurto if she knew of anyone else who saw significant portions of the event that she felt I should speak with. Basurto responded, "No, honestly no." Basurto stated that there was a guy who "seemed to be very involved in the scene, ... it looked like it was the owner from.... the tanning salon which was across from where everything happened." Basurto said that person was wearing a black t shirt and khaki shorts and a hat. Basurto said that it seemed odd to her that this person was "so involved", as he provided one of the officers a towel and he handed them water. Basurto stated, "He would be a good person to talk to." (That person was identified as Dennis Barboza and he had already been interviewed by investigators). I told Basurto that in general terms, there was a good likelihood that we had already interviewed that person.

I provided Basurto my direct contact information and asked if she could scan in her initial notes and send them to me via email. I assured Basurto that her personal information (date of birth, home address and phone number) would be redacted out in the public release of the final report. I asked Basurto if there was anything else she would like to add or felt that I had not asked. Basurto replied, "No." I let Basurto know that if she had any problems scanning in her original notes, I would have an investigator pick them up from her.

As of October 12, 2018, I had not received Nicole Basurto's initial notes via email. On October 12, 2018, I sent a letter to Nicole Basurto at her home address, along with a pre-addressed, postage-paid envelope, asking her to email the notes to me or send a copy back in the enclosed envelope. (Please refer to attached letter- Follow up Letter to Nicole Basurto)

As of November 20, 2018, I have not received any email, return envelope or phone call from Nicole Basurto with or about her initial notes.

**Disposition:**

Attach to Original Report

CONTROLLED DOCUMENT

Prepared By:  
80202 MASSEY, BILL

Date:  
10/05/2018

Approved By:  
80240 WARREN, JOHN

Date:  
12/18/2018





**Investigation:**

On October 3, 2018, I was the on-scene Officer Involved Critical Incident Team Supervisor for the event that occurred in Millbrae at approximately 1301 hours. Due to the fairly large area that the scene covered, I requested assistance from the Menlo Park Fire Department, specifically due to their UAS/Drone capabilities. Menlo Park Fire Department Captain Chris Dennebaum ultimately responded to the scene in Millbrae, along with a second Menlo Park Firefighter. MPFD Captain Dennebaum secured all of the necessary Federal Aviation Administration (FAA) clearances to launch the MPFD UAS/Drone over the scene.

Captain Dennebaum took a total of 46 digital photographs and 2 videos of the incident scene, utilizing the UAS/Drone. Captain Dennebaum provided me with a digital storage card that contained those 46 photos and 2 videos. I uploaded those photos and videos to the digital case file on a server at the San Mateo County District Attorney's Office. (SMCO DA's Office Bureau Case #18-1003-02, Evidence Items #8 and 9).

**Disposition:**

Attach to Original Report

**CONTROLLED DOCUMENT**

Prepared By:  
80202 MASSEY, BILL

Date:  
10/05/2018

Approved By:  
80240 WARREN, JOHN

Date:  
12/18/2018



**SAN MATEO COUNTY DISTRICT ATTORNEY'S OFFICE**

400 COUNTY CENTER, 3RD FLOOR REDWOOD CITY, CA 94063 650-363-4636

**SUPPLEMENT 4 - DSA and OSS Attorneys Regarding  
Voluntary Blood Draw Request**

Page 1

18-1003-02

**Investigation:**

On October 3, 2018, I was the on-scene Officer Involved Critical Incident Team Supervisor for the event that occurred in Millbrae at approximately 1301 hours. During the afternoon, I had telephone conversations with association representatives and/or attorneys who represented the involved San Mateo County Sheriff's Office Deputies and Sergeant.

I spoke with San Mateo County Deputy Sheriff's Association President, DJ Wozniak regarding a request for voluntary blood draws from San Mateo County Sheriff's Deputies Demartini, Lorenzatti, Watt and Wang. Wozniak told me that he had been in contact with attorneys from Mastagni Holstedt, who represent the San Mateo County Deputy Sheriff's Association. Wozniak stated that the attorneys from Mastagni Holstedt would not agree to provide voluntary blood samples from the involved Deputies.

I also spoke with Attorney Sarah Burdick from Rains Lucia Stern St. Phalle and Silver, PC. Sarah Burdick represented Sergeant David Weidner, as he is a member of the San Mateo County Organization of Sheriff's Sergeants. Sarah Burdick stated that it is the policy of her law firm not to provide voluntary blood samples and as such, Sergeant Weidner would not provide a voluntary blood sample out of this incident.

**Disposition:**

Attach to Original Report

**CONTROLLED DOCUMENT**

Prepared By:

80202 MASSEY, BILL

Date:

10/05/2018

Approved By:

80240 WARREN, JOHN

Date:

12/18/2018



**Investigation:**

I was given contact information from Deputy Pedro Miqueo regarding a potential witness (Paul Neily) who is a Millbrae Public Works employee who may have witnessed part of the incident. I met with Paul Neily at a Public Works shop located in Central Park in Millbrae. This interview took place on October 5, 2018 at approximately 11:10 AM. The interview was audio recorded with Neily's knowledge. Below is Paul Neily's paraphrased statement.

**Statement of Paul Neily:**

In the beginning of the interview, Paul Neily volunteered that after the incident occurred, he discovered the man involved (decedent) was Chinedu Okobi. Neily said he knew Okobi from high school and they had even played football and soccer together. Neily said he hadn't seen Okobi in the last 10-15 years and at the time of the incident he didn't even know Okobi was involved because of the dramatic physical changes in Okobi's appearance since the last time he had seen him.

Paul Neily told me he is a Senior Maintenance Worker for the City of Millbrae. Neily reported he has been working for the City of Millbrae for approximately 14 years. On the day of the incident, Neily said he was driving northbound on El Camino Real in a Public Works vehicle. Neily was headed to South San Francisco to pick up some rain gear and rain boots for some co-workers. While Neily was stopped in his truck in the far-left lane at a red light, he noticed a Sheriff's Office pickup truck stopped in the far-right northbound lane of El Camino Real at Millwood Ave. Neily noted that the light bar was turned on the Sheriff's Office truck.

Paul Neily said he first saw Decedent Okobi when the traffic signal turned green. Okobi was wearing a blue shirt with possibly gray pants. Neily said Okobi was in the center island median of El Camino Real near the Tri-Counties Bank. Neily remarked that Okobi looked as though he was already in a confrontation with a deputy and was back pedaling. Neily then saw a tall Asian deputy, with his baton out, saying something to Okobi. Neily confirmed he couldn't hear what the deputy was saying to Okobi. Neily saw the Asian deputy swing the baton at Okobi and saw that the baton grazed Okobi's stomach. Neily said Okobi then charged at the deputy, knocking the baton out of the deputy's hand. Neily said the deputy and Okobi then got tangled up in a struggle, "kind of like wrestling."

During this time, other deputies joined in and Decedent Okobi went down to the ground. At this point, Paul Neily was still sitting in his truck, and he saw one of the deputies get up and it looked as though the deputy had been pepper sprayed. Neily exited his truck and got a water bottle for the deputy. Neily estimated that he was approximately 5 to 10 yards from where Okobi went down to the ground. Neily added that one or two additional deputies also got pepper sprayed and he supplied them with water as well.

Paul Neily said the deputies ultimately got Decedent Okobi handcuffed and rolled Okobi over. Neily remembered that the deputies reported that Okobi had a pulse and that he was alive. Neily also heard the deputies call on the radio for backup and fire and ambulance. Neily estimated that there was 4 or 5

**CONTROLLED DOCUMENT**

Prepared By: 80213 SUZUKI, ERIC	Date: 10/09/2018	Approved By: 80240 WARREN, JOHN	Date: 12/17/2018
------------------------------------	---------------------	------------------------------------	---------------------



deputies involved in the incident. Neily confirmed that he did not see anyone use the Taser on Okobi.

Once Decedent Okobi was secured in handcuffs Paul Neily asked one of the deputies if he needed to stay. The deputy told him that he needed to provide a statement about what he had seen. Neily then moved his truck and one of the deputies (possibly Deputy Demartini) obtained his statement.

**End of Statement**

**Disposition:**

Attach to Original Report

**CONTROLLED DOCUMENT**

Prepared By:  
80213 SUZUKI, ERIC

Date:  
10/09/2018

Approved By:  
80240 WARREN, JOHN

Date:  
12/17/2018





**INVESTIGATION:**

I was given contact information from Deputy Pedro Miqueo regarding a witness (Robert Garrison) who had a video recording of the incident. I called Garrison and set up an interview with him. I met Garrison at his parent's house at [REDACTED]. This interview took place on October 3, 2018 at approximately 1630 hours. The interview was audio recorded with Garrison's knowledge. Below is Robert Garrison's paraphrased statement.

**STATEMENT OF ROBERT GARRISON:**

Robert Garrison reported that it was between 1:00PM and 1:30PM and he was at the teller stand inside the bank (Tri Counties Bank) across from where the incident with the deputies took place. Garrison heard some of the bank tellers start to yell. When Garrison turned around to see what was happening he saw two police cars stop nearby. Garrison walked over to the window of the bank and that's when he saw the man (Decedent Chinedu Okobi). Garrison said, "He looked really crazy, he was just going around like he was going to fight somebody, and that's when they tased him, and that's when I pulled my phone out."

Robert Garrison said the first video he recorded was when Decedent Okobi was on the ground being tased. Garrison said in the next videos you see Okobi "squirming around a little bit, still resisting and had his hands up, ripped the tase off, got up, got tased a second time, body went into shock, fell and then I didn't see him when he was behind the cop car."

Robert Garrison continued, "But when I moved I see the Decedent Okobi get up again and started running east towards northbound El Camino and in between the time of videos where he dragged one of the officers down to the ground, umm, resisting and assaulting the officer and then when he got up again in one of the videos you'll see he throws a punch, it'll be on the right side of the video, throws a punch and then throws another one and that's when he got dragged to the ground, and then there's videos of him being subdued on the ground."

I confirmed with Robert Garrison that he recorded the video with his iPhone and it was all obtained from inside the bank right up against the window. Tri Counties Bank is located at 1551 El Camino Real in Millbrae. The bank is on the west side of El Camino Real with the front of the bank facing east. The bank is located between Santa Helena Avenue to the north and Capuchino Drive to the south.

When Robert Garrison first saw Decedent Okobi, Okobi was on the sidewalk nearest southbound El Camino Real. Initially he saw about three officers near Okobi, then Okobi moved to the roadway on southbound El Camino Real. Garrison said it looked to him as though Okobi was running from the officers and had ripped off his sweater "like he was getting ready to fight or flee." Garrison explained that was when Okobi was tased the first time. Okobi, Garrison said, was tased by the "tall, Asian American officer." Garrison said Okobi fell to the ground and looked like he was trying to get up. As the deputies were trying to approach him and get him to cooperate and "maybe arrest him" but Okobi was moving around a lot.

**CONTROLLED DOCUMENT**

Prepared By: 80213 SUZUKI, ERIC	Date: 10/09/2018	Approved By: 80240 WARREN, JOHN	Date: 12/18/2018
------------------------------------	---------------------	------------------------------------	---------------------



**CONTROLLED DOCUMENT**

Decedent Okobi appeared to rip off the taser (probes) before getting up from the ground. As Okobi got up, he swung and knocked the glasses off of "a short, Caucasian officer." After Okobi got up and knocked the glasses off the officer, Okobi was tased a second time. Garrison explained that Okobi went down to the ground again and that's when Garrison moved to view the incident from a different vantage point.

Robert Garrison couldn't see anything else until Decedent Okobi got up a second time. After Okobi got up the second time, he started walking (light jogging) away from the officers; first south, then east towards the northbound lanes of El Camino Real. Robert Garrison said that Okobi had moved to the northbound lanes of El Camino Real when he saw him grab the tall Asian officer "probably around the neck area and drag him onto the ground." Okobi also went to the ground then got back up and walked back into the southbound lanes of El Camino Real. The Asian officer got up, followed Okobi, and that's when Okobi punched the Asian officer in the face. Okobi threw another punch as the team of officers brought Okobi to the ground. Garrison said there was a lot of "squirming" on the ground for what he estimated to be 5 to 10 minutes. Finally, Okobi looked subdued and was handcuffed. Garrison then saw fire personnel and an ambulance arrive. Garrison stopped video recording after Okobi had been successfully handcuffed, and his shirt was up. Garrison reported that Okobi was sitting up and "looked like he was conscious for sure." Garrison noted that it looked like Okobi was being loaded onto a gurney when he left.

Robert Garrison described Decedent Okobi as, "Very large, 6 feet or taller, heavy build, African American, weight maybe 270." Garrison said Okobi had been wearing blue jeans and a blue sweater, which he ripped off before Garrison started the recording, and a blue or gray shirt underneath the sweater. Garrison further estimated Okobi as being 38-45 years old with medium length hair.

The only time Robert Garrison heard anything being said during the incident was before Decedent Okobi got teased the first time. More specifically, Garrison heard a tall, bald, heavy, Caucasian male officer telling Okobi to stay still, and telling him to comply before the taser deployment.

I asked Robert Garrison if all the deputies were in full uniform and he said, "Yes, all in full uniform."

I asked Robert Garrison if he saw the deputies use any other type of force during the incident. Garrison said he saw the tall deputy he described as Caucasian, stocky, bald officer use the baton. Garrison clarified that he saw that specific officer hit Decedent Okobi once with the baton, but Okobi walked off and it appeared to him as though Okobi didn't feel anything. Garrison said he didn't see anyone use any pepper spray and didn't see any officers draw a firearm.

Robert Garrison voluntarily sent me the videos he had recorded of the incident from his iPhone. Garrison provided me with a total of six video recordings. Garrison explained that he stopped and

Prepared By:	Date:	Approved By:	Date:
80213 SUZUKI, ERIC	10/09/2018	80240 WARREN, JOHN	12/18/2018



started the recordings multiple times because he didn't want the video files to be too large.

**END OF STATEMENT**

**DISPOSITION**

Attach to Original Report

**CONTROLLED DOCUMENT**

Prepared By:

80213 SUZUKI, ERIC

Date:

10/09/2018

Approved By:

80240 WARREN, JOHN

Date:

12/18/2018



**INTERVIEW WITH INVOLVED OFFICER ALYSSA LORENZATTI:**

On October 4, 2018 at approximately 3:50 PM, I interviewed San Mateo County Sheriff's Office Deputy, Alyssa Lorenzatti, in the San Mateo County District Attorney's Office Interview room. Deputy Lorenzatti was an involved officer in the Officer Involved Critical Incident (OICI) on October 3, 2018. Present in the interview room was Attorney Zebulon Davis, from the Law Firm of Mastagni Holstedt, representing Deputy Lorenzatti. I explained to Deputy Lorenzatti the investigation process and advised her that the interview was being audio and video recorded. I confirmed with Deputy Lorenzatti that she was consenting to the interview, that she was not being ordered to provide a statement, that her statements were free and voluntary, and that she was free to leave at any time. Deputy Lorenzatti acknowledged this by saying, "Yes sir." Attorney Davis concurred.

Prior to the interview, Deputy Lorenzatti along with Attorney Davis watched the MAV Video recording of the incident that was captured from her assigned patrol vehicle. Deputy Lorenzatti and Attorney Davis also viewed a video taken by civilian witness Robert Garrison from inside of the Tri-Counties Bank located at 1551 El Camino Real in Millbrae. The video taken by Garrison was shown to Deputy Lorenzatti without audio, the MAV was shown with audio. The following is a synopsis of the interview:

**PERSONAL/WORK HISTORY:**

Deputy Lorenzatti has been in law enforcement for approximately 5 years; 2 years with the San Mateo County Sheriff's Office and prior to that she spent 3 years with the California Highway Patrol (CHP). Deputy Lorenzatti has worked for the Special Response Team (Riot Unit) for the CHP, is certified as a Drug Recognition Expert, trained in Crisis Intervention Training (CIT), and has worked various assignments for the Sheriff's Office including the jail, headquarters patrol, and is currently assigned to patrol in the City of Millbrae.

Deputy Lorenzatti is currently assigned to Patrol Team 1 and works a 6:00 AM to 6:00 PM shift with rotating days on/off. Today's shift was her first day back at work. She confirmed there were no unusual or high intensity calls for service prior to this incident. Deputy Lorenzatti was easily identifiable as a police officer. Deputy Lorenzatti said the uniform she was wearing on this day was her Sheriff's Office department issued navy wool pants and navy short sleeve shirt. The uniform shirt had Sheriff's Office patches on both arms and she was wearing her badge.

Deputy Lorenzatti was wearing a black duty belt and is right handed. On her duty belt Deputy Lorenzatti carried her duty firearm (Glock 19), ASP collapsible baton, 2 Glock magazines, radio holder with radio, 2 sets of handcuffs and her department issued Taser. Deputy Lorenzatti was driving a fully marked, black and white, San Mateo County Sheriff's Office vehicle. The vehicle is a Ford Taurus and the vehicle number is #8.

**INCIDENT:**

On October 4, 2018, Deputy Lorenzatti was on duty and was at the Millbrae Police Substation at 581 Magnolia Avenue in Millbrae. She was in the report writing room when she heard Deputy Wang on the radio say he was going out on a subject. Deputy Wang then called for Code 3 cover, stating that someone was running in the traffic lanes on northbound El Camino Real at Millwood Drive.

**CONTROLLED DOCUMENT**

<b>Prepared By:</b> 80213 SUZUKI, ERIC	<b>Date:</b> 10/09/2018	<b>Approved By:</b> 80240 WARREN, JOHN	<b>Date:</b> 12/17/2018
---	----------------------------	---	----------------------------





Deputy Lorenzatti wasn't exactly sure what was happening, but she ran out to her patrol car to respond. Deputy Lorenzatti saw Sgt. Weidner and Deputy Watt heading to their cars as well. Deputy Lorenzatti activated her lights and siren and headed to the scene. As Deputy Lorenzatti was approaching the scene she saw Decedent Okobi. Deputy Lorenzatti described Okobi as a large black male adult with a blue shirt running in traffic, across the lanes of Northbound El Camino Real to south El Camino Real. Deputy Lorenzatti was approaching the scene from the south heading north on northbound El Camino Real. Deputy Lorenzatti estimated it took her between 30 seconds to 1 minute to arrive at the incident scene.

To get the best access to the Decedent Okobi, Deputy Lorenzatti started to drive on the wrong side of El Camino Real, against traffic, making sure all the other vehicles could see her coming that way. Deputy Lorenzatti stopped, parked her patrol vehicle in the southbound lanes of El Camino Real and exited out of her vehicle. Deputy Lorenzatti noted Deputy Wang's vehicle up ahead of her, further north, making a U-turn to come back southbound on El Camino Real. When Deputy Lorenzatti exited her vehicle Okobi, who she described as over 6 feet tall and 300 lbs., was now about 25 yards away from her and walking towards her. Okobi was carrying 2 large black bags in his hands. At this point they were both on the south sidewalk of El Camino Real. When Okobi was approximately 10-15 feet away from her, Deputy Lorenzatti told Okobi to stop and to put the bags down. Okobi said something to the effect of, "I didn't do nothing" or "I didn't do anything." Deputy Lorenzatti told Okobi to stop again. Okobi stared at Deputy Lorenzatti but continued to walk straight towards her.

Deputy Lorenzatti said, "It felt like he was just going to run me over if I didn't get out his way, he was going to walk right through me and barrel me over." Deputy Lorenzatti continued, "He had this look in his eyes, that he wasn't quite all there. He seemed like he might have been under the influence of something. I wasn't sure."

Deputy Lorenzatti said the Decedent Okobi still wasn't listening and kept walking towards her so she sidestepped him and went to grab his left arm. She explained that she attempted to apply a control hold on Okobi and tried to detain him. She did this based on the code 3 cover call, the information that Okobi was walking through traffic, and the fact that Okobi was not listening to any of her verbal commands. Okobi pulled away from her attempt at a control hold and continued traveling past her. Deputy Lorenzatti tried to grab his arm again but he flung his arms up in the air.

Deputy Lorenzatti said Decedent Okobi was actively resisting her efforts to detain him and she thought he needed to go down to the ground for her better gain control of him. Okobi was too big to physically control and nothing she had used so far had been effective. Deputy Lorenzatti was afraid for her safety and felt that someone was really going to get hurt. Deputy Lorenzatti thought Okobi might be too big to just take down to the ground so she attempted to sweep his leg out but it didn't work. Okobi was now waving his arms wildly in the air and swinging his fists. Deputy Lorenzatti heard Deputy Wang tell Okobi to stop or he was going to be tased. Deputy Wang gave Okobi multiple warnings and Okobi didn't saying anything that she could understand or remember. Deputy Lorenzatti said Okobi was, "kind of

**CONTROLLED DOCUMENT**



dancing around” and then Okobi went down to the ground as he was tased by Deputy Wang.

When Decedent Okobi went down to the ground, Deputy Lorenzatti planned on moving in quickly to handcuff him, but he fell away from her and by the time she got to him he had already rolled over onto his back. The deputies gave Okobi multiple verbal commands to roll over onto his stomach and at one-point Deputy Lorenzatti even tried to grab the Okobi's arm to help initiate getting him onto his stomach. That didn't work, and Okobi then grabbed at Deputy Lorenzatti's legs. Decedent Okobi continued to ignore their commands to turn over on his stomach.

At one point Decedent Okobi jumped up (she recalled this from watching the video footage) and got tased a second time by Deputy Wang. Okobi went down to the ground again but quickly got up again and started running away. Deputy Wang got in front of Okobi drew his ASP baton out. She heard Deputy Wang yell to Okobi to stop and saw Deputy Wang swing his ASP baton at him a few times; she didn't see how many times he swung or if he connected his blows. Deputy Lorenzatti said that Okobi seemed fixated on Deputy Wang. Deputy Lorenzatti saw Okobi swing at Deputy Wang and she didn't know if the Okobi hit him or not. Then out of the corner of her eyes, and to her left, Deputy Lorenzatti saw another deputy (unsure who) tackle Okobi to the ground. Deputy Lorenzatti jumped onto Okobi while he continued to fight and kick and not give up his hands despite continued commands from the deputies, “Give us your hands, give us your hands, stop resisting.” It was then that Deputy Lorenzatti was sprayed in the face with pepper spray.

Deputy Lorenzatti wasn't sure where the pepper spray came from but she confirmed that Decedent Okobi was still fighting with them at this point. Deputy Lorenzatti was blinded from the pepper spray but she put all her body weight onto Okobi and clamped down on her right side to prevent Okobi from trying to access her firearm.

Deputy Lorenzatti told me she never deployed her ASP baton because she felt Decedent Okobi was too strong and would have likely taken the ASP baton away from her. Deputy Lorenzatti reported that Okobi was still fighting and they didn't have control of him yet. Deputy Lorenzatti thought that if she could punch Okobi “in a soft spot, maybe it'll jolt his arm out.” Deputy Lorenzatti remembered punching at the Okobi's lower half of his body but her blows were not effective. Deputy Lorenzatti then grabbed her handcuffs and handed them to someone, she didn't know who. She remained in her position, on the lower half of the Okobi's body, until she heard that he was in handcuffs.

During the time when the deputies were trying to handcuff Decedent Okobi, Deputy Lorenzatti heard Sgt. Weidner call for medics. She confirmed this occurred before the Okobi was fully detained (handcuffed). Deputy Lorenzatti remembered Okobi getting rolled onto his side ultimately moved into a sitting position after being handcuffed. When the medics arrived, Deputy Lorenzatti remembered them checking Okobi's pulse and at that time the he had a pulse. She said at some point Okobi stopped responding to pain stimulus and the medics put him down onto his back and started CPR.

**CONTROLLED DOCUMENT**



I asked Deputy Lorenzatti if she had sustained any injuries during the incident. She said she received minor scraps on her right wrist and the top of her right forearm. She didn't remember how those injuries occurred but knew they were fresh injuries from the incident. Deputy Lorenzatti said she didn't seek or need medical attention for those injuries, she just received water at the scene to flush her eyes out from the pepper spray exposure. I asked Deputy Lorenzatti if she received any damage to her uniform or her personal protective equipment. Deputy Lorenzatti advised that her right shirt pocket had a small rip in it before the incident occurred and the rip was larger after the incident. Also, her right front pants pocket now had a small rip in it as well.

I asked Deputy Lorenzatti if she had consumed any alcohol within the prior 24 hours before her shift. Deputy Lorenzatti said that she had two beers at approximately 6PM to 7PM the prior night. I asked Deputy Lorenzatti if she took any medications at the time of the incident. Deputy Lorenzatti said she might have taken an over the counter [REDACTED] medicine [REDACTED] the night before but wasn't sure.

Deputy Lorenzatti told me that she has successfully used her CIT training during past incidents and I asked her if she felt that CIT could have been used in this situation. Deputy Lorenzatti said, "No. Everything happened very fast, and from the moment I got on scene, he wasn't listening to anything we said, and he was becoming more and more of a risk to the public and us as it went on".

I asked Deputy Lorenzatti if she recognized Decedent Okobi and she said she did not recognize Okobi and she did not recall any prior contacts with the Okobi.

At the end of the interview I asked Deputy Lorenzatti and Attorney Zebulon Davis if they had any questions. Deputy Lorenzatti and Attorney Zebulon Davis had no questions.

**END OF STATEMENT**

**DISPOSITION**

Attach to Original Report

**CONTROLLED DOCUMENT**

Prepared By:  
80213 SUZUKI, ERIC

Date:  
10/09/2018

Approved By:  
80240 WARREN, JOHN

Date:  
12/17/2018

**INTERVIEW WITH DEPUTY ALYSSA LORENZATTI**

**Q= Inspector Eric Suzuki**

**A=Deputy Alyssa Lorenzatti**

**A1=Zeb Davis**

1  
2  
3  
4  
5  
6  
7  
8  
9  
10  
11  
12  
13  
14  
15  
16  
17  
18  
19  
20  
21  
22  
23  
24  
25  
26  
27  
28  
29  
30  
31  
32  
33  
34  
35  
36  
37  
38  
39  
40  
41  
42  
43  
44  
45

Q: Okay.

((Crosstalk))

Q: Thanks.

Man: (Unintelligible).

Q: Okay. Hi.

A: Hi.

Q: Okay. Eric Suzuki. How you doin'?

A: Alyssa. Nice to meet you.

Q: Hi.

A1: Hi, I'm Zeb.

Q: Nice to - nice to meet you.

A1: Here's a wa- card. I...

Q: Oh.

A1: ...forgot to give it to the other guy, so...

Q: No problem.

A1: He's got my phone number, but...

Q: Card...

A1: That's got all of my contact information...

Q: Card.



46 A1: ...on it, so...

47

48 Q: Okay. So what I'm gonna do is, uh, it's being video recorded but I'm, uh, s-  
49 uh, audio record this as well, okay?

50

51 A: Okay.

52

53 Q: Uh, that way it's just something that I have myself and makes it, uh, it's just  
54 kind of a double-check to make sure that everything's gonna be recorded  
55 somewhere, so let me make sure I get this goin', first. Uh, so how this is  
56 gonna work is basically, uh, we'll just go over the introductions, the easy  
57 stuff, uh, just kinda, you know, talk a little bit about yourself, your  
58 background, things like that, and then I'll let you go into a, like, a free-flow  
59 narrative, just kinda start to finish. I won't interrupt you at all. Um, I'll just be  
60 jotting stuff down. Um, those are just questions or something that I might  
61 have to follow up with, um, but I'll wait 'til the end for that, and then you can  
62 confer with your attorney at any point during the - the interview, and stop the  
63 interview at any time, and things like that.

64

65 A: Okay.

66

67 Q: Okay? So just be relaxed, honest. If you don't know the answers, that's fine.

68

69 A: Okay.

70

71 Q: Okay?

72

73 A: Mm-hm.

74

75 Q: So it is Thursday, October 4 and it is approximately 1550 hours. This  
76 Inspector Eric Suzuki with San Mateo County District Attorney's Office, and  
77 I am with...

78

79 A: Deputy Alyssa Lorenzatti with the San Mateo County Sheriff's Office.

80

81 Q: Okay.

82

83 A1: And I'm Zeb Davis, an attorney with Mastagni Holstedt.

84

85 Q: Okay. So I just wanted to, uh, let you know, Alyssa, that this is a free and  
86 voluntary, um, interview, okay? Uh, no one is compelling you to be here. Uh,  
87 you don't have to answer any questions that you don't want to, and you're  
88 free to leave at any time.

89

90 A: Okay.

91  
92 Q: You understand that?  
93  
94 A: Yes, sir.  
95  
96 Q: Okay. So let's start with your full name, and can you spell your first and last  
97 name?  
98  
99 A: Uh, yes, sir. It's Alyssa Lorenzatti. Uh, my first name is A-L-Y-S-S-A.  
100  
101 Q: Okay.  
102  
103 A: Last name is L-O-R-E-N-Z-A-T-T-I.  
104  
105 Q: Okay. And your agency and your badge number?  
106  
107 A: Uh, San Mateo County Sheriff's Office and badge number 1033.  
108  
109 Q: Mm. Okay. And how long have you been with the Sheriff's Office?  
110  
111 A: Uh, approximately two years.  
112  
113 Q: Two years, okay. And have you been employed, uh, by any other law  
114 enforcement agency prior?  
115  
116 A: Yes, sir.  
117  
118 Q: Okay.  
119  
120 A: The California Highway Patrol.  
121  
122 Q: Okay. And how long were you there?  
123  
124 A: Uh, almost three years.  
125  
126 Q: Three years, okay. And what's your current assignment?  
127  
128 A: Um, patrol in the Millbrae uh, Police Bureau.  
129  
130 Q: Okay. So can you talk about what assignments you've had between the CHP  
131 and the Sheriff's Office?  
132  
133 A: Uh, yes, sir. I've, uh, when I was with CHP I worked, uh, patrol, only.  
134  
135 Q: Okay.

136  
137 A: Um, I was on their Special Response Team down in the Southern Division  
138 which is, uh, like, the - kinda the riot team...  
139  
140 Q: Okay.  
141  
142 A: ...that they have there. Uh, I got certified with the CHP as a drug recognition  
143 expert.  
144  
145 Q: Okay.  
146  
147 A: Um, when I came to the Sheriff's Office I was first assigned to, uh, the jail, to  
148 Maguire Correctional Facility.  
149  
150 Q: Okay.  
151  
152 A: After that, I went out to, uh, FTO with the Sheriff's Office for a couple  
153 months and then was assigned, mm, uh, I been assigned to, uh, headquarters,  
154 patrol, uh, Maple Street Correctional Center, as well as, uh, Maguire...  
155  
156 Q: Okay.  
157  
158 A: ...since I've been here, and then, now, Millbrae.  
159  
160 Q: Okay. And then, where did you do most of your time with the CHP?  
161  
162 A: Um, I did almost two years in, uh, central Los Angeles, and then about a year  
163 up in Redwood City.  
164  
165 Q: Okay. So, for - for some of the questions, I'm gonna ask, um, I want you to try  
166 to re- to try to go off your memory, first. Um, I know that you - you just saw  
167 some videos. Can you tell me what videos you actually watched?  
168  
169 A: Um, my MAV video and a civilian video.  
170  
171 Q: Okay. And did the civilian video have any type of audio at all?  
172  
173 A: No.  
174  
175 Q: Okay. So you watched just your MAV video with audio?  
176  
177 A: Yes.  
178  
179 Q: Okay. And then a civilian video with no audio?  
180

181 A: Yes.  
182  
183 Q: Okay. Um, so i- if - if you - if there's a- any point in time that you, uh, are  
184 giving a statement but you remember that that's what you rel- recollected off  
185 the video, um, just let me know if - if that's a recollection that you remember  
186 firsthand or if it's something that you just remembered n- after the fact by  
187 viewing the video.  
188  
189 A: Okay.  
190  
191 Q: Okay? If you can.  
192  
193 A: Okay.  
194  
195 Q: Okay? So were you on-duty at the time of the incident?  
196  
197 A: Yes.  
198  
199 Q: Okay. And what time did your shift start that day?  
200  
201 A: Um, 6:00 o'clock in the morning.  
202  
203 Q: Okay. And what time did you get to work?  
204  
205 A: Um, think I got to work a little after 5:00.  
206  
207 Q: Okay. And then what was your duty assignment that day?  
208  
209 A: Um, it was, uh, uh, the beat was Boy 61, which is, uh, more of the, uh, south  
210 side of Millbrae.  
211  
212 Q: Okay. And is that your - your normal area that you - you work?  
213  
214 A: Yes.  
215  
216 Q: Okay. Were you driving your normally-assigned vehicle that day?  
217  
218 A: Yes.  
219  
220 Q: Okay. And what n- do you know the vehicle number?  
221  
222 A: Uh, 8.  
223  
224 Q: Okay. And can you describe the - the vehicle?  
225



226 A: It's a, uh, Ford Taurus, uh, black and white patrol vehicle.  
227  
228 Q: Okay.  
229  
230 A: Police vehicle.  
231  
232 Q: Full markings?  
233  
234 A: Yes.  
235  
236 Q: Okay. And lights and siren...  
237  
238 A: Yes.  
239  
240 Q: ...on top? Okay. Car number on the vehicle itself?  
241  
242 A: Uh, the number is 8. I don't know what the license plate number is.  
243  
244 Q: Okay. And do you know if the, uh, emergency equipment was functioning  
245 properly that day?  
246  
247 A: Yes.  
248  
249 Q: Okay. Can you describe your uniform to me? What were you wearing that  
250 day?  
251  
252 A: Uh, I was wearing, um, my Sheriff's Office-issued, um, mm, uh, wool  
253 uniform. I was wearing a short-sleeved shirt with Sheriff's Office patches.  
254  
255 Q: Okay.  
256  
257 A: Um, I had my badge, uh, n- on my left side. I was wearing the blue wool  
258 pants.  
259  
260 Q: Okay. No type of outerwear?  
261  
262 A: No.  
263  
264 Q: Okay. No hat or anything like that?  
265  
266  
267 A: No hat.  
268  
269 Q: Okay. And the badge that you're wearing, was it a metal badge or was it a  
270 cloth badge?

271  
272 A: Um, metal.  
273  
274 Q: Okay. So you believe that you were easily identif- identifiable as a police  
275 officer?  
276  
277 A: Yes.  
278  
279 Q: Okay. Okay. And what type of equipment do you carry on your person, um,  
280 when you're at work?  
281  
282 A: Um, I have, uh, m- so I'll - I guess I'll just start from the middle...  
283  
284 Q: Sure.  
285  
286 A: ...and go around. I have, um, my two magazines for my duty weapon and then,  
287 uh, pepper spray and, um, my personal - it's a Glock 19 that I've qualified  
288 with...  
289  
290 Q: Mm-hm.  
291  
292 A: ...with the office. It's a 9-millimeter.  
293  
294 Q: Okay.  
295  
296 A: Um, behind that I have my ASP, and then coming around I have a, um, it was  
297 empty at the time. It was a, um, flashlight holder.  
298  
299 Q: Okay.  
300  
301 A: And then, um, my radio holder with my radio and my office-issued Taser, and  
302 then the double handcuff case.  
303  
304 Q: Okay. And are you right-handed or left-handed?  
305  
306 A: I am right-handed.  
307  
308 Q: Right-handed, okay. And you carry, then, your Taser on your...  
309  
310 A: Left side.  
311  
312 Q: Left side. Okay. Were you working with a partner?  
313  
314 A: Uh, no, I was in the vehicle by myself.  
315

316 Q: Okay. And do you normally work with your partner?  
317  
318 A: Uh, no, we were in our own vehicles.  
319  
320 Q: Okay. And who was your direct supervisor that day?  
321  
322 A: Uh, Sergeant Weidner.  
323  
324 Q: Okay. And is he your normal supervisor?  
325  
326 A: Yes, sir.  
327  
328 Q: Okay. And then this was your normal shift and assignment?  
329  
330 A: Yes, sir.  
331  
332 Q: Okay. And when did you complete your last shift prior to that shift?  
333  
334 A: Um, would've been - that was our Monday so, um, what was yesterday?  
335 Yesterday was Wednesday?  
336  
337 Q: Yeah.  
338  
339 A: Um, Sunday.  
340  
341 Q: Sunday. Okay. So you had just come off, uh...  
342  
343 A: Two days off.  
344  
345 Q: Two days off, okay. And then prior to that shift, um, when did you sleep?  
346  
347 A: Um, I think I went to bed around maybe 8:00 or 9:00.  
348  
349 Q: Okay. So pretty early.  
350  
351 A: Yeah.  
352  
353 Q: And then what time did you get up?  
354  
355 A: Uh, f- around 4:00.  
356  
357 Q: Okay. And then, how did you sleep? Do you remember?  
358  
359 A: Mm, I - fine. Nothing out of the ordinary.  
360

361 Q: Okay.  
362  
363 Q: So when you started shift that day you felt - you felt fine? No...  
364  
365 A: Yes.  
366  
367 Q: ...no issues? Okay. Um, talk a little bit about what kind of calls that you had  
368 handled prior to, uh, the incident happening.  
369  
370 A: Um, so I got into work and I was ready to go by 5:30 and, uh, Deputy Wang  
371 got called to a, uh, like, a noise complaint. Um, well, the night shift did but we  
372 were already ready to go so we took if for them so they could go home.  
373  
374 Q: Okay.  
375  
376 A: Um, at Starbucks, right down the street, so Deputy Wang and I just walked  
377 over there and, um, talked to that guy and told him - he was using a leaf  
378 blower p- too early, so we just told him to stop.  
379  
380 Q: Okay.  
381  
382 A: And then, uh, went back to the station. Um, and then we had briefing, and  
383 then after briefing, um, I had a - think it was - it was a - a la- uh, a neighbor  
384 had called about - her resident left a gate open or found it open.  
385  
386 Q: Mm-hm.  
387  
388 A: She had found it open the day before, closed it, saw it open again, thought it  
389 was suspicious, so...  
390  
391 Q: Okay.  
392  
393 A: Uh, we went out there and did a walk around the house, closed the gate.  
394 Everything was secure. Uh, then I had training at the, uh, range.  
395  
396 Q: Okay.  
397  
398 A: From 8:00 to - I think we got around 11:30ish.  
399  
400 Q: Okay.  
401  
402 A: Um, driving training, and then from there, uh, went back to the substation, ate  
403 lunch, uh, and then the - this incident happened.  
404  
405 Q: Okay. So during none of those calls and n- to you were any type-high stress



406 calls?

407

408 A: No.

409

410 Q: Okay. And then prior to that, uh, you were on your off days, but do you  
411 remember any high-stress calls during that week prior?

412

413 A: Mm.

414

415 Q: Anything out of the ordinary?

416

417 A: No.

418

419 Q: Okay. So what I want you to do now is just kind of, uh, remember back to the  
420 incident itself and then just kinda do a free-flow narrative, starting from where  
421 you were, what was dispatched, and then just kinda go through the whole  
422 incident, and then what happened after. Okay?

423

424 A: Mm-hm. Mm-hm. Uh, so we just finished eating lunch in the briefing room. I  
425 was in the report writing room, working on a, uh, stolen vehicle report I had  
426 taken the prior week. Um, when I heard, uh, Deputy Wang go on the radio,  
427 um, uh, he said something to the effect of he was going out with a subject, uh,  
428 and then I heard him call for Code 3 Cover. There was someone running in the  
429 lanes.

430

431 Q: Okay.

432

433 A: So I wasn't super certain what was going on.

434

435 Q: Mm-hm.

436

437 A: Um, I know that when people are running in and out of lanes it's not usually a  
438 good sign, and he called for Code 3 Cover, so...

439

440 Q: Right.

441

442 A: I ran out to my patrol car. I think, uh, Sergeant Weidner was right behind me,  
443 followed by Deputy Watt.

444

445 Q: Okay.

446

447 A: I'm not sure of the order but that's just what I remember seeing as I ran out.

448

449 Q: Okay.

450

451 A: Um, got out my car, um, got to the gate, threw on my lights and s- siren, came  
452 on, and headed to the scene.  
453

454 Q: Mm-hm.  
455

456 A: Uh, got there. Um, as I was approaching the scene I could see, um, it was, uh,  
457 a large black male adult with a blue shirt running across El Camino. Um...  
458

459 Q: Okay.  
460

461 A: I think he was on the northbound side, or just crossing from the northbound  
462 side to the southbound side when I got on-scene.  
463

464 Q: Okay.  
465

466 A: Um, so I, um, started to go on the wrong way of traffic, made sure all the  
467 vehicles saw that I was coming that way.  
468

469 Q: Mm-hm.  
470

471 A: Parked my patrol car and got out. Um, at this point the - the male was walking  
472 towards me and, um, confirmed that he was very large, probably - on my  
473 estimate when I got there, I was thinking he was, like, 300 pounds and over  
474 six feet tall.  
475

476 Q: Okay.  
477

478 A: Um, he started walking towards me. I told him to stop.  
479

480 Q: Mm-hm.  
481

482 A: I think he said something like, "I didn't - I didn't do nothin'," or, "I didn't do  
483 anything." I d- don't know the exact verbiage he used.  
484

485 Q: Yeah.  
486

487 A: Told him to stop again. Um, I don't remember how many times. I know it was  
488 multiple times.  
489

490 Q: Mm-hm.  
491

492 A: Um, he just kinda stared at me and kept walking towards me and it felt like he  
493 was gonna just run me over if I didn't, uh, get out of the way. Had this look in  
494 his eyes just like...  
495

496 Q: Okay.  
497  
498 A: He wasn't quite - wasn't quite all there.  
499  
500 Q: Mm-hm.  
501  
502 A: Um, he seemed like he might be under the influence of something. I wasn't  
503 really sure.  
504  
505 Q: Okay.  
506  
507 A: I just know he wasn't listening to what I was saying. Um, so I went to grab  
508 his, um, left arm and then he pulled away, and I remember him - his hands in  
509 the air and I remember more people coming and I remember trying to grab  
510 him again, and he's still, like, flailing his hands in the air and I'm, um, before  
511 that, I think as I was grabbing his left arm...  
512  
513 Q: Mm-hm.  
514  
515 A: Sorry, I just kinda remembered it again.  
516  
517 Q: Sure.  
518  
519 A: He had a bunch of bags, and I told him to put 'em down and, uh, he wasn't -  
520 and the same time I was telling him to stop, I was telling him, "Put it down."  
521  
522 Q: Right.  
523  
524 A: He didn't put anything down. I didn't know what was in the bags, if he was  
525 gonna swing 'em at us, if he was gonna grab something in there that could be  
526 a weapon, so I grabbed them, threw them on the ground and, um, you know,  
527 couldn't get his hand 'cause he pulled it away and, uh, so then more of us  
528 came in. We were trying to grab him. Um, at this point I was like, I - he needs  
529 to go to the ground, he's y- actively resisting.  
530  
531 Q: Mm-hm.  
532  
533 A: I thought, "I'm not gonna be able to - he's big. None of us are gonna be able  
534 to fight him, like..."  
535  
536 Q: Right.  
537  
538 A: "...standing up," so I went to - I tried to attempt, like, a leg sweep.  
539  
540 Q: Mm-hm.

541  
542 A: I - it was unsuccessful. I don't remember if I made contact with his leg or not.  
543 I know I tried to get the back of his leg so he'd get down.  
544  
545 Q: Right.  
546  
547 A: Um, he just started throwing his hands wildly. I heard Deputy Wang say,  
548 "Stop, we're gonna Tase you." Um, I don't - you know, it was several times. I  
549 don't remember how many times he said it.  
550  
551 Q: Mm-hm.  
552  
553 A: Um, the gentleman was still fighting, say- y- I don't - I couldn't understand  
554 what he was saying. It was - it wasn't - I couldn't just un- understand him.  
555  
556 Q: Sure.  
557  
558 A: He was just goin' on and, um, kinda, like, almost, like, dancing around, like,  
559 jumping around kinda, just - it was really weird.  
560  
561 Q: Okay.  
562  
563 A: And, uh, um, then he gets Tased. Um, he went to the ground. I tried to, um,  
564 based on my training I know it's a good idea to try and handcuff someone  
565 while they're under power.  
566  
567 Q: Mm-hm.  
568  
569 A: Um, but he fell a little bit away from me, and I tried to get to him, and he, by  
570 then, already rolled over on his back.  
571  
572 Q: Okay.  
573  
574 A: Tried to get him to get onto his stomach. We gave him several commands,  
575 "Get on your stomach - get on your stomach." I think I even - I tried grabbing  
576 his arm to roll him over, but he was a lot bigger than me, so that didn't work,  
577 either.  
578  
579 Q: Okay.  
580  
581 A: And he started grabbing at my leg- like, just flailing his hands and then...  
582  
583 Q: Mm-hm.  
584  
585 A: At some point he was kinda just layin' there with his hands up and, like,



586 behind him, but, like, he wa- he just wouldn't do what we said, "Get on your  
587 stomach - get on your stomach." He wouldn't do it. At one point he jumped  
588 up, uh, and this is gonna be more memory from the video.

589  
590 Q: Mm-hm.

591  
592 A: Um, I remember him jumping up a bunch of times but, th- like, at this point,  
593 this is where the video...

594  
595 Q: Sure.

596  
597 A: ...reflected my r- or r- helped with my recollection.

598  
599 Q: Okay.

600  
601 A: He, like, jumped up and then got Tased again. Um, and he went down again.  
602 Um, but I don't - shortly after that he got up again and started running away.  
603 Uh, Deputy Wang, I think, got in front of him. Um, I saw Deputy Wang take  
604 his ASP out and swing it a few times. I didn't see how many times, or where  
605 he connected. I was just trying to get in a position to try and, uh, kinda help  
606 whatever I could. He seemed really fixated on Deputy Wang at that point.

607  
608 Q: Mm-hm.

609  
610 A: Um, and then outta the corner of my eye I saw another deputy. I c- I didn't  
611 know at the time who it was -- um, and I'm actually not even still sure -- just  
612 come from my left and just tackle him.

613  
614 Q: Mm-hm.

615  
616 A: So then I jumped on him and he was still fighting and kicking, wouldn't give  
617 us his hands. We're giving him commands, "Give us your hands." Um, you  
618 know, "Stop resisting," I don't remember the exa- I just know there was a lot  
619 of - a lot of talking, a lot of instructions and, uh, then all of a sudden I got hit  
620 in the face with pepper spray. Wasn't really sure where it came from.

621  
622 Q: Okay.

623  
624 A: Um, and I couldn't see and I was, you know, at that point I just - he was still  
625 fighting, so I just put all my body weight, um, on him and I, like, clamped  
626 down on my right side...

627  
628 Q: Mm-hm.

629  
630 A: ...'cause I wasn't sure where his hands were and I was afraid he might try and

631 grab my gun or someone else's gun so I was like, "I - I can't see, I can't go a  
632 lot, so I'm just..."

633  
634 Q: Sure.

635  
636 A: "...gonna put all my weight on him and hope that at least where I'm at he  
637 doesn't do anything."

638  
639 Q: Okay.

640  
641 A: Um, grabbed my handcuffs, handed 'em to somebody, don't know who. Um,  
642 and I just - seriously just - I just stayed there until they said, you know, "We  
643 got him in cuffs," and heard our sergeant through the whole thing - I think  
644 before we even had him completely detained, called for medics. Um, uh,  
645 eventually he just stopped fighting and then he was handcuffed and, you  
646 know, I rinsed my face off and, uh, medics came on-scene.

647  
648 Q: Okay. So when you got, uh, dispatched, how many people do you think were  
649 going to the call and - do you know?

650  
651 A: Um, I remember for sure it was, um, three of us...

652  
653 Q: Mm.

654  
655 A: ...that I saw go out of the station.

656  
657 Q: Mm. Okay. And then when you were en-route to the call, did you hear any  
658 updates? You heard a call for - for Code 3 cover, and then did you hear  
659 anything else on the way there?

660  
661 A: Um, I heard north, like, that he was northbound on El Camino.

662  
663 Q: Okay.

664  
665 A: Uh...

666  
667 Q: Did you know what - what you were going there for at that point?

668  
669 A: The only thing I knew was there was a - a male subject running in lanes.

670  
671 Q: Okay.

672  
673 A: And that it was Code 3 Cover.

674  
675 Q: Okay.

676  
677 A: That's...  
678  
679 Q: And can you give your route of travel, um, where you, you know, like,  
680 streets?  
681  
682 A: I'm...  
683  
684 Q: If you remember?  
685  
686 A: Honestly, I just got to Millbrae a couple weeks ago so I don't...  
687  
688 Q: Okay.  
689  
690 A: ...re- remember what streets. I know that we went left onto Magnolia, heading  
691 north.  
692  
693 Q: Okay.  
694  
695 A: Uh, I made a right at some point. I don't remember what street it was. Um,  
696 and then I made a left going northbound on El Camino.  
697  
698 Q: Okay. So you were approaching from northbound El Camino?  
699  
700 A: Yes.  
701  
702 Q: Okay.  
703  
704 A: From...  
705  
706 Q: And then...  
707  
708 A: Approaching from the south.  
709  
710 Q: South.  
711  
712 A: Going north.  
713  
714 Q: Going north. Okay. And then, uh, how long do you think it took you to get  
715 there from - you were at headquarters?  
716  
717 A: Uh, yes.  
718  
719 Q: Okay.  
720

721 A: I was at - well, Millbrae Station.  
722  
723 Q: Okay.  
724  
725 A: Um, couldn't have been more than 30 seconds to a minute.  
726  
727 Q: Okay.  
728  
729 A: I'm not really - it was pretty fast.  
730  
731 Q: Okay. So you're going northbound from the southbound direction, and then  
732 what do you see? Where is the suspect at that point when you're driving up?  
733  
734 A: Once I got closer, I saw him get onto the center median and then start, like,  
735 looked like he was dodging cars and just running...  
736  
737 Q: Okay.  
738  
739 A: ...through, and then I saw Deputy Lang - Wang's lights as he was turning  
740 around.  
741  
742 Q: Okay. So he was in his vehicle at that point?  
743  
744 A: Yes.  
745  
746 Q: Okay. And was he going southbound at that point?  
747  
748 A: He was makin' a U-turn from northbound, so when I saw him - I saw his car  
749 as it started to come around.  
750  
751 Q: Mm-hm.  
752  
753 A: Um, and - so then he was going southbound.  
754  
755 Q: Okay. And then where - where did you end up parking?  
756  
757 A: I parked, um, in the southbound direction of El Camino.  
758  
759 Q: Okay.  
760  
761 A: Um, at an angle to the curb.  
762  
763 Q: Okay. So then you got outta the car at that point and then how far away was  
764 the suspect at that time?  
765



766 A: Mm, maybe f- he was pro- tryin' to think. I'm not great with, uh, estimations  
767 on distances sometimes. Um, maybe 25 yards.  
768

769 Q: Okay. And did he see you immediately?  
770

771 A: I'm not sure.  
772

773 Q: Okay. So then you started to approach him on foot.  
774

775 A: Mm-hm.  
776

777 Q: Um, at that point when you got outta the car and th- started to approach him,  
778 where was Deputy Wang at that point?  
779

780 A: I don't know.  
781

782 Q: Okay.  
783

784 A: I didn't - I didn't...  
785

786 Q: You didn't see him?  
787

788 A: Mm-mm.  
789

790 Q: Okay. And as you were approaching, when did you get his attention?  
791

792 A: Um, he was maybe - I mean, I was right in the middle of the sidewalk and he  
793 was right in the middle of the sidewalk, so maybe, like, te- I don't know, 10  
794 feet away is my best guess. 10, 15 feet away.  
795

796 Q: Okay. And what's the first thing you said to him?  
797

798 A: Um, I said, "Stop," and s- what I remember saying. I just remember sayin',  
799 "Stop."  
800

801 Q: Okay. So at that point, he acknowledged you and did he say anything at that  
802 time?  
803

804 A: Yeah. I don't remember the order of when he said it, but I do remember him  
805 saying, "I didn't do anything." Something to that effect. And I said, "Well,  
806 hey, just stop."  
807

808 Q: Okay.  
809

810 A: Um, "Put your stuff down," that s- started - 'cause he (jus-) never stopped

811 walking. He just kept walking forward towards me.  
812  
813 Q: Okay.  
814  
815 A: So at that point I was just tryin' to tell him just, "Hey, stop - stop."  
816  
817 Q: Okay.  
818  
819 A: Yeah.  
820  
821 Q: So then you attempted to go hands-on by grabbing his arm.  
822  
823 A: Yes.  
824  
825 Q: Okay. And that's when you said he kinda pulled away?  
826  
827 A: Yes.  
828  
829 Q: Okay. And then at what point did Deputy Wang get there to assist you?  
830  
831 A: He was there pretty much as soon as - 'cause I knew everyone was close, so -  
832 so as soon as I grabbed him arm, everyone was pretty much right there. I don't  
833 know.  
834  
835 Q: Okay. So at that time, there was other deputies there, as well?  
836  
837 A: Mm-hm.  
838  
839 Q: Okay. Do you remember who was there with you?  
840  
841 A: Um, n- I mean, no, not...  
842  
843 Q: Okay.  
844  
845 A: ...exactly.  
846  
847 Q: And then at that time, where were you standing? Were you still in the same  
848 location when - when everybody arrived, or had you moved at all?  
849  
850 A: I moved behind him.  
851  
852 Q: Okay.  
853  
854 A: Kind of, like, when I grabbed hi- went to - when I went to grab his hand I  
855 kinda stepped to the side so that he wouldn't, like, run me over.

856  
857 Q: Okay.  
858  
859 A: Or hit me or anything, and I went to grab his hand and then that's when he f-  
860 kind of came away, and I went around the back of him.  
861  
862 Q: Okay. So, uh, so how many deputies do you estimate are around him at that  
863 point?  
864  
865 A: Uh, I think there were, like, four of us.  
866  
867 Q: Okay. And was he standing or was he on the ground?  
868  
869 A: He was standing.  
870  
871 Q: Okay. So what happened next, then? What happened to - what escalated to the  
872 - to the - to the next level after that?  
873  
874 A: Um, like I said, I think I tried to do, like, a legs-type sweep thing.  
875  
876 Q: Mm-hm.  
877  
878 A: Tryin' to get him to the ground, and he just started swinging his hands. I saw  
879 him, like, I - from what I remember, I saw him, like, swinging his fist around  
880 and I heard, "Stop, you're gonna get Tased," and, um, I thought for sure one  
881 of us was about to get hit in the face or get hit somewhere and get...  
882  
883 Q: Right.  
884  
885 A: ...hurt, and then I - and then he got, um, Tased and then...  
886  
887 Q: Okay. So you heard the warning, the a- admonishment, uh, of the Taser.  
888  
889 A: Mm-hm.  
890  
891 Q: And then you saw the Taser being deployed.  
892  
893 A: Yeah.  
894  
895 Q: Do you remember who was doing that?  
896  
897 A: Uh, it was Deputy Wang.  
898  
899 Q: Okay. So Deputy Wang does the Taser.  
900

901 A: Mm-hm.  
902  
903 Q: Okay. And did you see the Taser hit him?  
904  
905 A: Um, I don't really rem...  
906  
907 Q: Did...  
908  
909 A: I mean, I saw him falling. I don't remember if I saw the Taser itself...  
910  
911 Q: Okay.  
912  
913 A: ...hit him.  
914  
915 Q: So do you - do you think he fell in - in your mind, did he fall in reaction to  
916 bein' - to bein' hit with the Taser?  
917  
918 A: Yes.  
919  
920 Q: Okay. And did his body have any type of visible reaction, or did he make any  
921 type of noise?  
922  
923 A: Um, I saw his body lock up like it was a, um, like, a successful Taser hit.  
924  
925 Q: Okay.  
926  
927 A: And - and he just fell over.  
928  
929 Q: Okay. And then what happened from that point, then?  
930  
931 A: That's when I tried to go get him in handcuffs while he was still on a - I th- I  
932 mean, I remember, you know, tryin' to get him under power.  
933  
934 Q: Mm-hm.  
935  
936 A: And - and he rolled over on his back and then, um, I remember him, like, just  
937 swinging his arms at us, and then it stopped for a minute, and just giving him  
938 commands to get on his stomach and him not getting on his stomach.  
939  
940 Q: Okay. So then, um, the deputies - you and the deputies are around him. He's  
941 still in the street. Now, he's on his back.  
942  
943 A: Mm-hm.  
944  
945 Q: Okay? And he's been Tased once.



946  
947 A: Mm-hm.  
948  
949 Q: Okay. And then what happens from there?  
950  
951 A: Um, that's where, like, th- everything starts to kinda, like, I d- didn't  
952 remember, really, the order until I saw the video.  
953  
954 Q: Okay.  
955  
956 A: Um, I remember, like, you know, "Stop, get on your stomach, you're gonna  
957 get," you know...  
958  
959 Q: Mm-hm.  
960  
961 A: I- I remember, like, hearing something about - I don't know if it was, "You're  
962 gonna get Tased again," or, "Tase him again," or - or something. Um, but then  
963 he jumped up and then that's when he got Tased again. He locked up again  
964 and...  
965  
966 Q: Okay.  
967  
968 A: ...fell down.  
969  
970 Q: So that second time - so when - when he gets up after he gets Tased the first  
971 time, um, does he move from his location or is he in the same location where  
972 he got Tased the first time?  
973  
974  
975 A: Um, I think he went forward a little bit. I know he, like, jumped. I remember  
976 thinking he was gonna grab my leg, so I jumped back, and then he got  
977 shocked again and he, like, fell down.  
978  
979 Q: He f- he went down again?  
980  
981 A: Yeah.  
982  
983 Q: Okay. So this is the second Tase, a- and you believe it's the same deputy.  
984  
985 A: Yes.  
986  
987 Q: It's Deputy Wang, still?  
988  
989 A: Yes.  
990

991 Q: Okay. So he goes down a second time, he falls down on the ground, and from  
992 your recollection you're still in the - the southbound lanes of El Camino?  
993

994 A: Yes.  
995

996 Q: Okay. And then what happened from there?  
997

998 A: And then he gets up again and starts running, um, and I remember I pulled out  
999 my Taser, like, thinking I might need to Tase him again. I didn't have a great  
1000 shot.  
1001

1002 Q: Mm-hm.  
1003

1004 A: It was kinda far, and then Deputy Wang at some point got in front of him  
1005 while I was behind him, so I put it back. Um, and then that's when I saw  
1006 Deputy Wang with his, uh, his ASP Baton out.  
1007

1008 Q: Okay.  
1009

1010 A: Um, swinging, telling him, "Stop," you know...  
1011

1012 Q: So it - and you said he took off, which - which direction was the suspect going  
1013 from there?  
1014

1015 A: He started running from - at, like, a diagonal angle, sort of, uh, south.  
1016

1017 Q: Okay.  
1018

1019 A: And then ended up in, uh, southbound - the southbound lanes of traffic, and  
1020 some cars were still driving.  
1021

1022 Q: Okay. So he starts running southbound on El Camino. Does he ever cross  
1023 back over the median at all that you remember?  
1024

1025 A: I don't remember. I mean, it wasn't...  
1026

1027 Q: Okay.  
1028

1029 A: I don't believe it was, like, a direct shot. I just...  
1030

1031 Q: Okay. So then...  
1032

1033 A: I remember going that direction and kinda, like, trying to corral him and  
1034 trying to - there were a lot of people out at this point and - I don't n- I mean,  
1035 he was...

1036  
1037 Q: Okay.  
1038  
1039 A: Uh...  
1040  
1041 Q: So then you said that he - he took off after the second Tase, and then you saw  
1042 - you guys kind of followed him. Were you walkin' along with him?  
1043  
1044 A: Yeah, I was kinda jogging after him.  
1045  
1046 Q: Okay.  
1047  
1048 A: Yeah.  
1049  
1050 Q: Um, and you said that you saw Deputy Wang pull out his baton after that?  
1051  
1052 A: Yes.  
1053  
1054 Q: Okay. And did you see him try to strike, or did anything happen at that point?  
1055  
1056 A: Yeah, I saw him swinging it. I don't know if it made contact, where it did, or  
1057 when.  
1058  
1059 Q: Okay.  
1060  
1061 A: Um, but I do remember him yelling like, "Stop."  
1062  
1063 Q: Okay.  
1064  
1065 A: And m- I - he was - he sounded scared.  
1066  
1067 Q: Okay.  
1068  
1069 A: And I saw him - I saw the gentleman swing at him, and I didn't know if he hit  
1070 him or not or what, and then that's when the other deputy a- at some point,  
1071 came in, tackled him (unintelligible).  
1072  
1073 Q: Okay. So you saw the suspect try to hit Deputy Wang, but you're not sure if  
1074 he contacted him or not?  
1075  
1076 A: Yeah, at that point, I didn't know.  
1077  
1078 Q: Okay. And then did you see, uh, Deputy Wang at any point after the second  
1079 Taser deployment, uh, try to deploy his Taser again after that?  
1080

1081 A: I don't remember.  
1082  
1083 Q: Okay. Okay. So suspect - you said that, um, from the corner of your eye you  
1084 saw another deputy and then, um, after the suspect tried to take a swing at  
1085 Deputy Wang, you saw somebody come and tackle the suspect?  
1086  
1087 A: Mm-hm.  
1088  
1089 Q: Okay. So the s- and then you helped along with that. So the suspect is down  
1090 on the ground at that point?  
1091  
1092 A: Yes.  
1093  
1094 Q: Okay. And is he on his stomach, or is he on his back?  
1095  
1096 A: I don't really remember.  
1097  
1098 Q: Okay. And then was he controlled at that point or...  
1099  
1100 A: No, he was still kicking and fighting, and we didn't have control of his hands.  
1101 I do remember I, um, thinking, um, if I can punch him in, like, a soft spot  
1102 maybe he'll jolt his arm out.  
1103  
1104 Q: Mm-hm.  
1105  
1106 A: Um, so I was, like, on his lower half. I know that much. I don't remember  
1107 exactly where I hit. It wasn't effective, it wasn't - I just - I wasn't trying to  
1108 hurt him.  
1109  
1110 Q: Right.  
1111  
1112 A: I was trying to get him in a soft spot where he would, like, let go.  
1113  
1114 Q: Mm-hm.  
1115  
1116 A: And then that didn't work so I was like, "Well, that's not gonna work," so I  
1117 just kinda held my position and then - then short - at s- some point then the  
1118 pepper spray came.  
1119  
1120 Q: Okay. So was he at - when he was down on the ground and you guys are  
1121 struggling to get arms out, right? You're basically trying to handcuff him at  
1122 that point.  
1123  
1124 A: Mm-hm.  
1125

- 1126 Q: Um, was he saying anything or yelling anything at that time?  
1127
- 1128 A: I don't remember.  
1129
- 1130 Q: Okay. And was anybody giving him any type of commands at that point?  
1131
- 1132 A: Yeah, there was a lot of - a lot of - I heard a lot of yelling, a lot of, like - like,  
1133 can't remember exactly what was said and I don't wanna try and...  
1134
- 1135 Q: Sure.  
1136
- 1137 A: But I do remember a lot of voices.  
1138
- 1139 Q: Okay. And then...  
1140
- 1141 A: A lot of things were happening.  
1142
- 1143 Q: Okay.  
1144
- 1145 A: I do - the one thing I do remember the most was, like, my sergeant going on  
1146 the air, asking for, "Code 3, fire," um, to, like, or medics or something, like,  
1147 "Code 3 Medics, just get ready to come in."  
1148
- 1149 Q: Okay. And do you...  
1150
- 1151 A: That was before we had him under control.  
1152
- 1153 Q: Okay. So he - he wasn't handcuffed at that point when they - they were  
1154 already calling for the medics?  
1155
- 1156 A: Yeah, not from what I remember.  
1157
- 1158 Q: Okay. So he's down on the ground, and how long do you think it took to - to  
1159 get him under control? How long were you guys struggling with him?  
1160
- 1161 A: I don't know. It felt like forever 'cause I had the pepper spray in my eyes and  
1162 I - it was hurting, and I couldn't see, and I just think - remember thinking,  
1163 like, I - "More people need to get here," like, "I can't stay on him too much  
1164 longer," 'cause...  
1165
- 1166 Q: Okay.  
1167
- 1168 A: ...he was still, like, kicking and fighting. I don't have an estimate of time.  
1169
- 1170 Q: Okay. And at what part of the body were you at that point?



1171  
1172 A: I was on his lower half.  
1173  
1174 Q: Lower half? Okay. And do you know, um, specifically any positions that the  
1175 other deputies were at on his body?  
1176  
1177 A: No, I don't.  
1178  
1179 Q: Okay. So prior to the point of - of getting pepper sprayed, uh, the suspect and  
1180 then also yourself...  
1181  
1182 A: Mm-hm.  
1183  
1184 Q: Um, you s- he had said the Taser had gotten used twice that you saw.  
1185  
1186 A: Mm-hm.  
1187  
1188 Q: And then a baton or ASP was deployed at - at one point...  
1189  
1190 A: Mm-hm.  
1191  
1192 Q: ...by Deputy Wang.  
1193  
1194 A: Mm-hm.  
1195  
1196 Q: Um, did you see any other type of uses of force, uh, during the incident? You  
1197 said that you tried to throw a punch to get him to put his arms out.  
1198  
1199 A: Yeah, I...  
1200  
1201 Q: Um, other than those incidents, do you remember any other type of force  
1202 being used or did you see...  
1203  
1204 A: No, I just remember trying to get control of his hands.  
1205  
1206 Q: Okay.  
1207  
1208 A: Like, we were - all of us were trying to get con- he was just out- I mean, he  
1209 was swing- I mean, they were all over the place. I mean, he was big and we  
1210 couldn't grab him at all.  
1211  
1212 Q: Okay. Did anybody else deploy their ASP that you remember?  
1213  
1214 A: Not that I remember.  
1215

1216 Q: Okay.  
1217  
1218 A: I don't know.  
1219  
1220 Q: And do you remember if anybody tried to do a carotid or anything like that  
1221 around his neck?  
1222  
1223 A: Not that I...  
1224  
1225 Q: Or his head?  
1226  
1227 A: No, not that I remember.  
1228  
1229 Q: Okay.  
1230  
1231 A: Not that I saw. I mean, I didn't see it.  
1232  
1233 Q: Okay. So how long do you think you were on him before you got hit with the  
1234 spray?  
1235  
1236 A: Mm, I don't - I don't know.  
1237  
1238 Q: Okay. And then after you got hit with the pepper spray, you couldn't see at  
1239 all?  
1240  
1241 A: Yeah, I couldn't see at all.  
1242  
1243 Q: Okay. And you - you basically were just kind of h- leaning on him and then  
1244 you can just verbally hear things goin' on from that point?  
1245  
1246 A: Yeah. Yeah.  
1247  
1248 Q: Okay. And then at that point, how long did it take for him to b- to be  
1249 handcuffed that you remember after you got hit with the pepper spray?  
1250  
1251 A: Um, it still felt like it was quite a while.  
1252  
1253 Q: Okay.  
1254  
1255 A: 'Cause I was, like I said, I was r- just really hoping somebody would come tap  
1256 me out, or someone would - more people would come 'cause I was, like...  
1257  
1258 Q: Right.  
1259  
1260 A: ...like, "We need to get him handcuffed, like, I cannot see."

1261  
1262 Q: Okay. So when he did get handcuffed, you were still - you were still there,  
1263 though? No one had relieved you at that point?  
1264  
1265 A: Right.  
1266  
1267 Q: And you still had the - the effects of the pepper spray?  
1268  
1269 A: Yes, sir.  
1270  
1271 Q: Okay. And then, what position was he at if you - if you knew after he got  
1272 handcuffed?  
1273  
1274 A: I d- I didn't know.  
1275  
1276 Q: Okay. So after he's handcuffed, when did you get relieved? How long did it  
1277 take?  
1278  
1279 A: Um, I still never r- really got relieved. Someone handed me a bottle of water.  
1280  
1281 Q: Mm-hm.  
1282  
1283 A: And I put it on my face and then, um, I remember us, mm, rolling him onto  
1284 his side. I don't remember from what position.  
1285  
1286 Q: Okay.  
1287  
1288 A: Um, and then eventually sitting him up.  
1289  
1290 Q: Okay. So he was sitting up at some point and at that point you think the  
1291 handcuffs were on him?  
1292  
1293  
1294 A: Oh, yeah.  
1295  
1296 Q: Behind his back?  
1297  
1298 A: He was already - by the time we rolled him onto his side, his - the handcuffs  
1299 were on.  
1300  
1301 Q: The handcuffs were on him?  
1302  
1303 A: (Unintelligible).  
1304  
1305 Q: And they were on him behind his back?

1306  
1307 A: Yes.  
1308  
1309 Q: Okay. And then were the medics or fire there at that point, or not yet?  
1310  
1311 A: Um, they were on their way. I could see 'em coming down and I heard, uh, it  
1312 was kinda a lot of chaos and commotion but, uh, you know, sergeant or  
1313 someone saying, "It's Code 4 for fire," like, "Get 'em in here."  
1314  
1315 Q: Okay. And then did you actually - were you still there when fire came on-  
1316 scene?  
1317  
1318 A: Yes.  
1319  
1320 Q: Okay. And then what did you see them do?  
1321  
1322 A: Um, they took - checked his pulse, uh, a couple of them tended to Deputy  
1323 Wang.  
1324  
1325 Q: Mm-hm.  
1326  
1327 A: Um, I was - at that point I moved to his - his back, he was leaning up on my  
1328 knee and, uh, they were just, like, getting ready, um, they're ch- they were  
1329 checking his pulse. They're like, "He has a pulse, he has..." He responded at  
1330 one point.  
1331  
1332 Q: Mm-hm.  
1333  
1334 A: And then stopped responding to pain stimulus while they were trying to do it,  
1335 I think, and then...  
1336  
1337 Q: Okay.  
1338  
1339 A: They were like, "Well, let's get him on his back and start CPR," so then I, you  
1340 know, helped 'em bring him to his back.  
1341  
1342 Q: Okay.  
1343  
1344 A: And then they started CPR. Then I was - I was...  
1345  
1346 Q: Okay.  
1347  
1348 A: ...done with that.  
1349  
1350 Q: So - and that was the medics or fire that started the CPR?

1351  
1352 A: I don't remember.  
1353  
1354 Q: Okay. And were his handcuffs off at that point?  
1355  
1356 A: No, they were still on.  
1357  
1358 Q: Okay. So talk a little bit about, um, what you were feeling personally and why  
1359 you did what you did as far as your use of force, and what you thought was  
1360 gonna work or - or what - what wasn't gonna work just because of the  
1361 situation.  
1362  
1363 A: Yeah. Um, you know, m- first got there, like I said, it was, "Code 3 cover,"  
1364 call, so I was - did - not really sure what happened, but I knew it wasn't, um,  
1365 he called for Code 3 cover for a reason.  
1366  
1367 Q: Mm-hm.  
1368  
1369 A: And I saw him, I didn't, you know...try to get him to stop. Um, the look in his  
1370 eyes, um, was s- similar to the look I've seen in people who've been under the  
1371 influence of dissociative anesthetics. Um, and I, you know, it - he had been  
1372 running so I was like, "I don't - the - I don't need him," like, just - he looked  
1373 like he was, like, when he was walking towards me he was gonna, like, just  
1374 walk right through me and just...  
1375  
1376 Q: Right.  
1377  
1378 A: ...barrel me over, so that's when I went to the side. And then once the fight  
1379 was on it was, uh, nothing was working. Like, nothing, and we were just -  
1380 someone was calling for m- more Code 3 cover and I just remember, like, th- I  
1381 just - I didn't know what was gonna work. I was just trying - I knew he  
1382 needed to be brought to the ground. That was gonna be our best chance and  
1383 no- nothing was working to get him to the ground.  
1384  
1385 Q: Right.  
1386  
1387 A: And then even when we got him to the ground, he was still fighting pretty  
1388 good and, uh, I don't know - I don't know, I just remember, like, thinking  
1389 someone was gonna get seriously hurt. Like, it was getting to that point.  
1390  
1391 Q: Okay.  
1392  
1393 A: And he was - like I said, when I f- when I first saw him, he was - he's a big  
1394 guy, and I'm not so big.  
1395



1396 Q: Mm-hm.  
1397  
1398 A: So I was like, "If I take one punch from him, I'm - I'm out. I'm - I'm done,"  
1399 and same li- I mean, Deputy Wang is not a very big guy, either.  
1400  
1401 Q: Right.  
1402  
1403 A: And I know he was fixated on him, so...  
1404  
1405 Q: Okay. So it's safe to say that you feared for your safety?  
1406  
1407 A: Yeah.  
1408  
1409 Q: Okay.  
1410  
1411 A: And then there were more people around and he was running, and we're  
1412 trying to make sure - I mean, he just - at - once it was on it was, like, he was -  
1413 once it was really on, he really wasn't stopping.  
1414  
1415 Q: Okay.  
1416  
1417 A: And I didn't know who was gonna get caught in his...  
1418  
1419 Q: Okay.  
1420  
1421 A: ...his whatever. His mindset. I didn't know who was gonna get caught in his -  
1422 his path.  
1423  
1424 Q: So you said earlier that he had, uh, he had tried to throw a punch at Deputy  
1425 Wang. Did you see him try to do anything else to Deputy Wang? Did he, um,  
1426 did they, um, did he take him down to the ground, or did you see any point  
1427 where he actually struck any officers or attacked any other officers during this  
1428 whole time?  
1429  
1430 A: I mean, the whole time I know he - he kept trying to gr- I - I have, like, when  
1431 he was on a - when he popped up at one point, felt like he was lurching at my  
1432 legs and, uh, when I saw the video it looked like he tried to grab, uh, Deputy  
1433 DeMartini. Um, like, I just remember the whole situation, like, his arms being  
1434 everywhere and just grabbing and swinging, and that's pretty much what I  
1435 remember in the moment.  
1436  
1437 Q: Okay.  
1438  
1439 A: Just, like, what I was feeling, like, he was just grabbing and swinging, and I  
1440 didn't want him to grab anything off my belt, or any - I mean, I was m- I

1441 didn't pull my ASP out because I knew if he got a hold of it, he would take it  
1442 right outta my hands, and it wouldn't...  
1443

1444 Q: Right.  
1445

1446 A: It wasn't good...  
1447

1448 Q: Okay. Um, at any time, did you see any type of weapons or anything in the  
1449 suspect's hands?  
1450

1451 A: No.  
1452

1453 Q: Okay. So you initially said that you had seen some bags in his hands. Do you -  
1454 do you have any idea what those were, or what he was carrying?  
1455

1456 A: I don't.  
1457

1458 Q: Okay.  
1459

1460 A: I don't even l- I mean, I d- seriously just pulled them off him so that they  
1461 wouldn't be used as a weapon, or he couldn't get into 'em if there was a  
1462 weapon or not. I didn't know 'cause they were closed.  
1463

1464 Q: Right.  
1465

1466 A: And then once they were off him, that was the end of - of those. I didn't see  
1467 'em again.  
1468

1469 Q: Okay. And do you recognize the - the suspect when you first saw him?  
1470

1471 Q: Have you had any prior type contacts with him?  
1472

1473 A: No.  
1474

1475 Q: Okay. And was there anything mentioned on the radio that you remember  
1476 hearing, uh, about the suspect or did he - was he not identified at that time?  
1477

1478 A: I don't, like, as far as, like, his identity, I just remember the descriptions.  
1479

1480 Q: Okay.  
1481

1482 A: (Unintelligible).  
1483

1484 Q: Okay.  
1485

1486 A: Blue shirt, was the thing that I remember.  
1487  
1488 Q: Okay. And - and since that time, have you learned of his identity?  
1489  
1490 A: Uh, no.  
1491  
1492 Q: Okay. Um, did you provide a Public Safety statement at all?  
1493  
1494 A: Uh, no.  
1495  
1496 Q: No?  
1497  
1498 A: I didn't. N- I didn't.  
1499  
1500 Q: Okay. And what type of recording vi- devices, if any, did you have on at the  
1501 time?  
1502  
1503 A: Um, my MAV for recording of my, uh, for my vehicle was on at the time.  
1504  
1505 Q: Okay. And is there a handheld device that you wear on - on your uniform to  
1506 activate it?  
1507  
1508 A: Um, there is an audio recorder.  
1509  
1510 Q: Mm-hm.  
1511  
1512 A: It was in my vehicle at the time.  
1513  
1514 Q: Okay.  
1515  
1516 A: Um, 'cause like I said, I'd been at training all day, and then I was in the office,  
1517 and then this came out.  
1518  
1519 Q: Okay.  
1520  
1521 A: So I didn't even have time or even think of...  
1522  
1523 Q: Sure.  
1524  
1525 A: ...grabbing it out.  
1526  
1527 Q: Okay. And then the MAV, though, in your vehicle automatically activates  
1528 when you...  
1529  
1530 A: Turn the lights on.

1531  
1532 Q: ...turn on your lighting. Okay. And then you had your Code 3 lighting on from  
1533 the time you left headquarters?  
1534  
1535 A: Yes.  
1536  
1537 Q: Okay. Um, do you wear any type of corrective lenses?  
1538  
1539 A: No.  
1540  
1541 Q: Okay. And do you know what your vision is?  
1542  
1543 A: I don't.  
1544  
1545 Q: Okay.  
1546  
1547 A: I just know I passed the vision test to get hired.  
1548  
1549 Q: Okay. And lighting at the time of the incident?  
1550  
1551 A: It was daytime.  
1552  
1553 Q: Okay. And was there anything obstructing, uh, your view or impairing your  
1554 visibility during the incident at all?  
1555  
1556 A: No.  
1557  
1558 Q: Okay.  
1559  
1560 A1: Other than the pepper spray.  
1561  
1562 A: Yeah, other than - I hate pepper spray.  
1563  
1564 Q: So at no time during the incident do you think that he was confused or didn't  
1565 know that you guys were police officers?  
1566  
1567 A: Um, no.  
1568  
1569 Q: It was apparent?  
1570  
1571 A: It was, I mean, he said, "I didn't do anything," which to me means he knew  
1572 that we were trying to talk to him, we were trying to stop him.  
1573  
1574 Q: Okay.  
1575

1576 A: So...

1577

1578 Q: And did you sustain any injuries from the incident?

1579

1580 A: Um, a li- couple scrapes and then - took a while for the effect of the pepper

1581 spray to wear off.

1582

1583 Q: Okay. And then where did the, uh, the scrapes, where, uh, did they, uh...

1584

1585 A: Uh, I have one on my, like, right wrist.

1586

1587 Q: Okay.

1588

1589 A: And then one on, like, the top of - or, yeah, I think it's the top of my right

1590 forearm.

1591

1592 Q: Okay. And then how did those occur?

1593

1594 A: I don't know.

1595

1596 Q: Okay.

1597

1598 A: I just noticed them afterwards, and they were fresh.

1599

1600 Q: Okay. Uh, did you need or did you get medical assistance at that time?

1601

1602 A: Uh, just the water.

1603

1604 Q: Okay.

1605

1606 A: At the scene. And then wiped it (unintelligible).

1607

1608 Q: Do you know if anybody else got any type of pepper spray on them, as well?

1609

1610 A: Um, I think Deputy Watt did, yeah.

1611

1612 Q: Okay. And was your equipment, um, damaged at any point during the

1613 incident? M...

1614

1615 A: Um, my...

1616

1617 Q: Pants or clothes or anything like that?

1618

1619 A: My right shirt pocket, uh, it had a small rip that was already starting, but it got

1620 bigger...



1621  
1622 Q: Okay.  
1623  
1624 A: ...um, afterwards. Uh, it was dust on my pants and, oh, I noticed when I gave  
1625 my clothes over that the - my right front pocket where my, uh, knife is that I  
1626 carry with me...  
1627  
1628 Q: Mm-hm.  
1629  
1630 A: ...it was, uh, ripped a little bit.  
1631  
1632 Q: Okay.  
1633  
1634 A: But...  
1635  
1636 Q: So prior to the day of your shift, um, had you consumed alcohol in the  
1637 previous 24 hours?  
1638  
1639 A: Yes.  
1640  
1641 Q: Okay. And how much?  
1642  
1643 A: Uh, I had - I think it was two beers the night before.  
1644  
1645 Q: Okay. And about what time was that?  
1646  
1647 A: Like, 6:00 or 7:00.  
1648  
1649 Q: Okay.  
1650  
1651 Q: And then you said you went to bed about 8:00?  
1652  
1653 A: Yeah, but...  
1654  
1655 Q: Okay. So you had no type of alcohol after 8:00 and before your shift?  
1656  
1657 A: Correct.  
1658  
1659 Q: Okay. And what about medication? Do you - did you take any type of  
1660 medication within the 24 hours prior?  
1661  
1662 A: I don't think so. I have [REDACTED] medication. It's, uh, [REDACTED], but  
1663 sometimes I forget to take it, so...  
1664  
1665 Q: Okay. And is that over the counter or is that prescribed?

1666  
1667 A: Uh, over the counter.  
1668  
1669 Q: Okay. Um, have you received any type of specialized training as far as, like,  
1670 tactical communications, hostage negotiations, CERT?  
1671  
1672 A: Yes.  
1673  
1674 Q: CIT?  
1675  
1676 A: I have CIT.  
1677  
1678 Q: Okay.  
1679  
1680 A: I was also a member of the SWAT Team for about a year.  
1681  
1682 Q: Okay.  
1683  
1684 A: Forgot to mention that.  
1685  
1686 Q: Okay. And for CIT, do you remember the specific type training that you  
1687 received?  
1688  
1689 A: Um, it was, um, like, mental health, uh, but I s- it was, like, two we- or it was,  
1690 like, a week or something.  
1691  
1692 Q: Okay. And that was, um, post-academy? It wasn't during the academy?  
1693  
1694 A: It was - no.  
1695  
1696 Q: It was special course?  
1697  
1698 A: It was here, through the Sheriff's Office.  
1699  
1700 Q: Okay.  
1701  
1702 A: It was the 40-hour...  
1703  
1704 Q: Okay.  
1705  
1706 A: ...course that they put on.  
1707  
1708 Q: Okay. And have you ever had to use any type of crisis intervention techniques  
1709 prior to that call?  
1710

1711 A: Um, yeah, I mean, I've - nothing like that where it's been, like, a - like, a f-  
1712 fight or anything or - I mean, I've - you know, I've had to place people on  
1713 5150 holds before and just talk to them and kinda keep 'em calm. Um...  
1714

1715 Q: And...

1716

1717 A: Like, sometime - I mean, I worked in the jail, too, and one of the spots I  
1718 worked was the, uh, ADSEG, the female ADSEG housing unit.  
1719

1720 Q: Mm-hm.

1721

1722 A: Um, and even the male ADSEG housing unit, so just having to talk to - a lot  
1723 of those people there have a mental health, uh, concerns and issues, so...  
1724

1725 Q: Okay. So you've used the crisis intervention training that you've received...  
1726

1727 A: Yeah.

1728

1729 Q: ...previously? Okay. And do you feel that this was an incident where any type  
1730 of crisis intervention could've worked?  
1731

1732 A: No.

1733

1734 Q: Okay. And why not?

1735

1736

1737 A: Um, everything happened very fast, and from the moment that I got on-scene,  
1738 he wasn't listening to anything that we s- said.  
1739

1740 Q: Okay.

1741

1742 A: And he was, uh, becoming more and more of a risk as it went on to the public  
1743 and to us.  
1744

1745 Q: Okay. So at any point, um, did you, uh, I know you - that you said he had a  
1746 look in his eyes, and that when he was talking he wasn't - he mainly wasn't  
1747 making sense. Do you remember him saying anything at all?  
1748

1749 A: The only thing I remember was, "I didn't - I didn't do anything."  
1750

1751 Q: Okay.

1752

1753 A: That's the only thing I remember.

1754

1755 Q: And that was...

1756  
1757 A: That was it.  
1758  
1759 Q: That was upon your initial...  
1760  
1761 A: Yeah.  
1762  
1763 Q: ...um, observation of him when you first made contact with him, right?  
1764  
1765 A: Mm-hm.  
1766  
1767 Q: Okay. Okay. Um, I'm gonna let you, uh, confer with your attorney for a  
1768 minute, okay?  
1769  
1770 A: Okay.  
1771  
1772 Q: Um, you can probably step out of this room, because the recording continues  
1773 to go.  
1774  
1775 A: Okay.  
1776  
1777 Q: Um, I'll see if there's gonna be any type of questions and you can - I'll - I'll  
1778 see if, uh, if my bosses or anybody has any type of follow-up questions for  
1779 you.  
1780  
1781 A: Okay.  
1782  
1783 Q: Okay? So it's not gonna be too much longer, so just take a breath, take a drink  
1784 of water, and then...  
1785  
1786 A: Okay.  
1787  
1788 Q: ...and then we'll meet back here in a couple minutes.  
1789  
1790 A: All right. Thanks.  
1791  
1792 Q: Okay?  
1793  
1794 Man: Wanna go out?  
1795  
1796 A1: Why don't we go and step in the other room? (Unintelligible).  
1797  
1798 (Parties return to interview room)  
1799  
1800 A1: So, yeah, just kinda treat it like a long weekend, you know what I mean?

1801  
1802 A: Yeah.  
1803  
1804 A1: And do the best to enjoy it. So...  
1805  
1806 Man: Yeah.  
1807  
1808 Q: Okay. Okay. We're almost there.  
1809  
1810 A: All right.  
1811  
1812 Q: So just a couple questions more. Um, we just wanna talk a little bit more  
1813 about the - the initial contact.  
1814  
1815 A: Mm-hm.  
1816  
1817 Q: So you leave headquarters and there's at least two other deputies leavin' at the  
1818 same time.  
1819  
1820 A: Mm-hm.  
1821  
1822 Q: Um, when you get on-scene, I'm assuming all three of you got on-scene at the  
1823 same time, or close to the same time?  
1824  
1825 A: I think so, yeah.  
1826  
1827 Q: And do you know if you guys all took the same routes or - or not? I mean, was  
1828 there, like, someone directly in front of you?  
1829  
1830 A: I - I wa- I was the front car. I remember looking back at one point and seeing  
1831 lights behind me.  
1832  
1833 Q: Okay.  
1834  
1835 A: Um, I don't know how many people were t...  
1836  
1837 Q: Okay.  
1838  
1839 A: If they took the - I know at one point, I think when we were on - after we  
1840 made that right from Magnolia, before we got onto El Camino, I looked back  
1841 and I saw lights behind me.  
1842  
1843 Q: Okay.  
1844  
1845 A: Um, so I don't know.



1846  
1847 Q: Okay. So then you make, uh, so you get outta the car, and you're not exactly  
1848 sure where Wang is at that point?  
1849  
1850 A: I knew his car was farther - 'cause when I r- came on-scene, I saw his car  
1851 making that U-turn.  
1852  
1853 Q: Okay. So he was making a turn.  
1854  
1855 A: But I knew he was north of me.  
1856  
1857 Q: Okay.  
1858  
1859 A: I just didn't know how far away he was.  
1860  
1861 Q: Okay. And then what about the deputies that came with you, uh, when you left  
1862 headquarters? Do you have any idea where their location was?  
1863  
1864 A: I f- figured they probably got there when I did. Like, when I've - I was, like,  
1865 I'm pretty sure they're with me. I wasn't...  
1866  
1867 Q: Okay.  
1868  
1869 A: ...certain.  
1870  
1871 Q: Well, when you got outta the car, n- you were by yourself, pretty much?  
1872  
1873 A: Uh, y- I mean, I didn't s- remember s...  
1874  
1875 Q: You didn't see anybody else with you? You didn't walk up with anybody?  
1876  
1877 A: Yeah.  
1878  
1879 Q: Okay.  
1880  
1881 A: Not that I...  
1882  
1883 Q: And so then when you got out of the car, wh- where did you first see the  
1884 suspect?  
1885  
1886 A: I saw him on - once I got outta the car, he was already under the - on the  
1887 sidewalk on the, um, was it the - west side. The west sidewalk.  
1888  
1889 Q: Okay.  
1890

1891 A: And that's where I was, and he was walking towards me at that point.  
1892  
1893 Q: Okay. And then - and you knew that that's what the - the cover call was  
1894 about? How - or how did you know that?  
1895  
1896 A: Uh, the blue shirt, and he - he's the one that I saw running in traffic...  
1897  
1898 Q: Okay.  
1899  
1900 A: ...as Deputy Wang was turning around.  
1901  
1902 Q: Okay. So then you confront him and you said he's maybe 25 yards away?  
1903  
1904 A: When I first saw him.  
1905  
1906 Q: When you first saw him.  
1907  
1908 A: Well - well, I mean, I saw him, but when I first saw him on the sidewalk when  
1909 I got outta the car, he was probably, like, 25 yards away.  
1910  
1911 Q: Okay. And then he starts walkin' towards you?  
1912  
1913 A: Mm-hm.  
1914  
1915 Q: Okay. And what, again, were your verbal commands at that point?  
1916  
1917 A: Um, what I remember saying was, "Stop." Um, I don't remember how many  
1918 times. I know it was multiple times.  
1919  
1920 Q: Mm-hm.  
1921  
1922 A: Um, I said, "Stop," something to the effect of that or, you know...  
1923  
1924 Q: Right.  
1925  
1926 A: Um, I remember, uh, and then I remember him saying, "I didn't do anything,"  
1927 then I said, "Hey, let's put your stuff down."  
1928  
1929 Q: Okay.  
1930  
1931 A: Um, something to that effect, 'cause I've had it before where someone has had  
1932 bags and they've swung and they've hit people that I've been working with,  
1933 and they've gotten hurt from that.  
1934  
1935 Q: Sure.

1936  
1937 A: So I wanted those out of play before we f- even finished...  
1938  
1939 Q: Okay.  
1940  
1941 A: ...any kind of contact or talk, or before we even started any kind of contact or  
1942 talking or...  
1943  
1944 Q: Okay.  
1945  
1946 A: ...hands-on.  
1947  
1948 Q: And then he didn't...  
1949  
1950 A: He didn't.  
1951  
1952 Q: ...put the bags down?  
1953  
1954 A: No.  
1955  
1956 Q: And...  
1957  
1958 A: He kept walking forward.  
1959  
1960 Q: He didn't respond at all?  
1961  
1962 A: Yeah.  
1963  
1964 Q: Okay. And then he continues to walk towards you?  
1965  
1966 A: Yes.  
1967  
1968 Q: Okay. So what - what's goin' through your mind at that point? What i- what is  
1969 your plan of action of what you're gonna do...  
1970  
1971 A: I was gonna...  
1972  
1973 Q: ...or why you were gonna do it?  
1974  
1975 A: I was gonna put him in a control hold and...  
1976  
1977 Q: Okay.  
1978  
1979 A: ...put handcuffs on him for our safety. That was what my th- mindset was.  
1980

1981 Q: Okay. And why?  
1982

1983 A: Uh, because of the Code 3 cover call, um, the fact that he wasn't listening, the  
1984 look that he had in his eyes, uh, the fact that he kept walking towards me. Uh,  
1985 I didn't really know the specifics of what happened...  
1986

1987 Q: Mm-hm.  
1988

1989 A: ...when Deputy Wang first contacted him. Like I said, all I knew was it's Code  
1990 3 cover and he was - there was a male running in lanes, which is not a normal  
1991 thing to do.  
1992

1993 Q: Okay.  
1994

1995 A: So I just wanted to get him in handcuffs and get the situation controlled...  
1996

1997 Q: Okay.  
1998

1999 A: ...right then and there and figure out why he was acting the way he was acting  
2000 and figure out, like, what had happened and what was going on.  
2001

2002 Q: Okay. So basically, based on what you just articulated, uh, you're j- you're  
2003 gonna try to detain him and - and the way that you were gonna try to detain  
2004 him was first by placing him in handcuffs?  
2005

2006 A: Well, first, I wanted to talk to him.  
2007

2008 Q: Right.  
2009

2010 A: But when he s- wasn't responding to my commands and my direction, then I  
2011 was, like, he - I would like to detain him in handcuffs...  
2012

2013 Q: Okay.  
2014

2015 A: ...for our safety and his safety and everything...  
2016

2017 Q: Okay.  
2018

2019 A: ...everyone else around.  
2020

2021 Q: And after that initial confrontation, how long did it take for you to recognize  
2022 or see, uh, your backup?  
2023

2024 A: Uh, pretty much as soon as he pulled away I saw, like, more deputies around  
2025 me.

2026  
2027 Q: Okay.  
2028  
2029 A: Uh, mm-hm.  
2030  
2031 Q: Okay. So you, uh, you tried to grab his arm at first, you pulled away, and at  
2032 that point, did you stop?  
2033  
2034 A: No, I continued to try to get control of him.  
2035  
2036 Q: Okay. And he kept pulling away at that point?  
2037  
2038 A: Yeah.  
2039  
2040 Q: Okay. So at one point you said that you, uh, during the incident - it was a little  
2041 bit later on in the incident that you had deployed, uh, you had taken out your  
2042 Taser.  
2043  
2044 A: Yeah, I took it out a couple times.  
2045  
2046 Q: Okay.  
2047  
2048 A: I don't remember the order or when or what.  
2049  
2050 Q: Okay. Uh, but you never y- deployed your Taser at all?  
2051  
2052 A: Correct.  
2053  
2054 Q: Okay.  
2055  
2056 A: I turned it on, uh, pointed it at him.  
2057  
2058 Q: Uh-huh.  
2059  
2060 A: I never - I didn't have a good - a good shot on him so I put it away.  
2061  
2062 Q: Okay. And then so you, um, took out your Taser a couple times, uh, and then,  
2063 uh, did you take out your ASP at any time during the incident?  
2064  
2065 A: No.  
2066  
2067 Q: Okay. And then...  
2068  
2069 A: Like I said before, I thought he would - if I took it out, he would take it from  
2070 me, and I didn't wanna add to the situation with that.



2071  
2072 Q: Okay. And then other than that, you said that you had to, uh, punch him to try  
2073 to get him to - get his hands out?  
2074  
2075 A: Yeah.  
2076  
2077 Q: And then where - where did you hit him?  
2078  
2079 A: Somewhere on his lower body. Um...  
2080  
2081 Q: Okay.  
2082  
2083 A: It didn't...  
2084  
2085 Q: Right hand, left hand?  
2086  
2087 A: I don't remember.  
2088  
2089 Q: Okay. And it was a punch that you remember?  
2090  
2091 A: Mm-hm.  
2092  
2093 Q: Okay. And you saw no visible reaction at all?  
2094  
2095 A: Mm-mm.  
2096  
2097 Q: Okay. And then if you think back to the part where - so you're pretty clear up  
2098 to the point where you said that you, uh, you saw Deputy Wang. He - he, uh, it  
2099 looked like he was, you know, getting a - a - a punch thrown at him...  
2100  
2101 A: Mm-hm.  
2102  
2103 Q: ...and then at that point, the suspect got taken down to the ground.  
2104  
2105 A: Mm-hm.  
2106  
2107 Q: Okay. And then how long do you think you were struggling with him before  
2108 you got hit with the pepper spray?  
2109  
2110 A: It wasn't - it didn't seem like it was very long.  
2111  
2112 Q: Okay.  
2113  
2114 A: But I - I don't have, like, a time estimate.  
2115

2116 Q: Sure. Okay. And then after that, after you got hit with the pepper spray, then  
2117 that's wh- you don't really remember too much after that?  
2118

2119 A: Yeah, just what I was hearing and just kinda what I was thinking was, like -  
2120 like, "Holy - holy crap, I can't - I can't see."  
2121

2122 Q: Okay. And was...  
2123

2124 A: "I don't know where his hands are, I don't know if anyone has his hands, I  
2125 don't want him - grab me or anything on my belt."  
2126

2127 Q: Okay.  
2128

2129 A: So I just hunkered down.  
2130

2131 Q: Okay.  
2132

2133 A: And then had my handcuffs in my left hand and was, like, they're li- so like,  
2134 "Handcuff him," I'm like, "I can't see - I can't see," so, like, someone  
2135 grabbed him and...  
2136

2137 Q: Okay. And was anybody taking charge at that point as far as, um, one of the  
2138 deputies or the sergeant as far as, like, giving commands or - or kind of, like...  
2139

2140 A: Um, it seemed like Sergeant Weidner was more of the one that was, like,  
2141 taking charge, but I don't remember everything that he was saying. The main  
2142 thing, I remember the medics.  
2143

2144 Q: Okay.  
2145

2146 A: Call for medics.  
2147

2148 Q: And was he talkin' to you guys or was he talkin' to the suspect? Or do you  
2149 remember?  
2150

2151 A: I remember him, uh, like, telling me just to, like - like, I had - 'cause I had  
2152 pepper spray in my eyes.  
2153

2154 Q: Mm-hm.  
2155

2156 A: Um, "I can't see." He's like, "Just - just stay in it - just stay in it," and I'm  
2157 like, "M- I'm here, I'm staying, and..."  
2158

2159 Q: Right.  
2160

2161 A: So I remember that, and I remember him calling for medics. Those were the  
2162 only specific words I remember him saying.  
2163

2164 Q: Okay. And then I - I know I've asked you this a couple times, but...  
2165

2166 A: Mm-hm.  
2167

2168 Q: Do you n- other than when you first encountered the suspect and - and he - he  
2169 kinda said, "Uh, I - I d- didn't do anything," um, do you remember anything  
2170 specific, uh, that the suspect said at any point during the confrontation at all?  
2171

2172 A: No.  
2173

2174 Q: Okay. Okay. Okay. So is there anything that we didn't go over or that you  
2175 remember when you think about the incident that you wanna bring up now, or  
2176 questions that I didn't ask, or things that you wanna say?  
2177

2178 A: I don't - I don't think so. I mean...  
2179

2180 Q: Okay.  
2181

2182 A: Everything happened really fast and I just - I wish I remembered more of it,  
2183 but...  
2184

2185 Q: And, counsel, do you have any questions, or do you have anything to ask your  
2186 client?  
2187

2188 A1: I have - I have no questions at this time.  
2189

2190 Q: Okay. All right. I will double check with my superiors and, um...I'm gon- just  
2191 gonna see if they have anything else...  
2192

2193 A: Okay.  
2194

2195 Q: ...uh, to add and otherwise, we'll be done, okay?  
2196

2197 A: Okay.  
2198

2199 Q: I'll be right back.  
2200

2201 A1: (Unintelligible).  
2202

2203 A: (Unintelligible).  
2204

2205 Q: Okay. Uh, if there is nothing further, we will end this interview. And it is

2206 1653 hours. Okay. Wasn't so bad, was it?  
2207  
2208 A: No.  
2209  
2210 Q: Okay. And you're done.  
2211  
2212 A: All right.  
2213  
2214 Q: All right.  
2215  
2216 A1: Not - not quite the grilling, you know...  
2217  
2218 A: Yeah.  
2219  
2220 A1: ...that the, uh, your worst nightmares. You know, imagine s...  
2221  
2222 A: Not - not like what you see on TV when you get...  
2223  
2224 A1: Oh, yeah.  
2225  
2226 A: When the officers get called in - in the - no.  
2227  
2228 Q: Okay. (Unintelligible) get some air, you're probably - it is stuffy in here.  
2229  
2230 A: Oh, thank you.  
2231  
2232 A1: Yeah, it is.  
2233  
2234 A: Mm.  
2235  
2236 A1: Where's the bathroom around here?  
2237  
2238 Q: Oh, I'll - I'll - I'll sh- I'll, uh, bring out the back  
2239  
2240 A1: It's gonna be a long drive, so...  
2241  
2242 Q: Okay. Thank you.  
2243  
2244 A1: Walk out with you, okay?  
2245  
2246 A: Mm-hm.  
2247  
2248 A1: Okay. All right. So how do we get there?  
2249  
2250 Q: I'll show you (unintelligible).



**SAN MATEO COUNTY DISTRICT ATTORNEY'S OFFICE**

400 COUNTY CENTER, 3RD FLOOR REDWOOD CITY, CA 94063 650-363-4636

**SUPPLEMENT 8 - Deputy Wang's Uniform and Equipment  
Collection and Chain of Custody**

**Investigation:**

During the evening hours of October 9, 2018, I met with San Mateo County Sheriff's Office Sergeant Szabolcs Szerenyi at the San Mateo County Sheriff's Office, Millbrae Substation. Sergeant Szerenyi opened Deputy Joshua Wang's secure locker (with Deputy Wang's permission) and turned over the following items to me:

1 Black basket weave duty belt with the following items:

- 1 empty magazine holder (for two magazines)
- 1 empty taser holster
- 1 empty collapsible baton holster
- 1 portable radio holder
- 1 portable radio (Motorola APX 7000, #12359199)
- 2 handcuff cases with 2 pairs of handcuffs inside
- 1 firearm holster
- 1 Glock Model 17 9mm Handgun (Serial #BFKS476) with Surefire X300 Ultra Light
- 1 pepper spray holder (with pepper spray canister inside)
- 1 empty tourniquet holder

4 belt keepers

1 Pelican 7060 LED Flashlight (#1100/ PD#4359)

1 inner ballistic vest with earpiece attached

1 long sleeve uniform shirt (had been dry-cleaned)

3 Glock 9mm magazines with 52 loose 9mm rounds

(I took a total of 10 digital photographs of the collected items. SMCO DA's Office Bureau Case #18-1003-02, Evidence Item #3.)

(It should be noted that the Glock 17 firearm had been rendered safe at the scene by San Mateo County Sheriff's Office Sergeant Jacob Trickett. The firearm and 3 magazines had been unloaded by the San Mateo County Crime Laboratory during the evening hours of October 3, 2018. The SMCO Crime Lab also took detailed photos of the above mentioned items on the evening of the incident and while the items were at the scene.)

I personally transported all of the listed items (using gloves) to the San Mateo County District Attorney's Office where they were locked in a secure storage area. On October 10, 2018, I removed all of the items from the secure storage area and I packaged the Glock 17 firearm, 3 magazines and the duty belt with all attachments for transportation to the San Mateo County Crime Laboratory. I re-secured all of the above items in secure storage on October 10, 2018 and then removed them again on the morning of October 11, 2018. Inspector Jamie Draper personally transported the Glock 17 firearm, along with Deputy Wang's duty belt and attachments to the San Mateo County Crime Laboratory for analysis on October 11, 2018 at approximately 0930 hours. (SMCO DA's Office Bureau Case #18-1003-02,

**CONTROLLED DOCUMENT**

Prepared By: 80202 MASSEY, BILL	Date: 10/11/2018	Approved By: 80240 WARREN, JOHN	Date: 12/17/2018
------------------------------------	---------------------	------------------------------------	---------------------





Evidence Items #1 and 2).

On October 8, 2018, I spoke with San Mateo County Sheriff's Office Sergeant Szabolcs Szerenyi regarding the chain of custody of Deputy Wang's uniform and equipment. The following is a summary of my conversation with Sergeant Szerenyi:

Sergeant Szerenyi stated that Sergeant Jacob Trickett returned to the Millbrae Police Substation on October 3, 2018 during the late evening hours (after the crime scene had been completely cleared). Sergeant Trickett provided Sergeant Szerenyi with Deputy Joshua Wang's duty belt, which contained the duty weapon in the holster. Sergeant Szerenyi stated that Sergeant Trickett also provided him with Deputy Wang's uniform shirt, ballistic vest, badge, flashlight, magazines and ammunition that had been emptied into a plastic bag and miscellaneous note pads and flash cards. Sergeant Szerenyi had been informed by Sergeant Trickett that the San Mateo County Crime Lab no longer needed the items for evidence. Sergeant Szerenyi received Deputy Wang's permission to open his secure locker in the Millbrae Police Substation men's locker room. Sergeant Szerenyi stated that he placed all of the above listed items into Deputy Wang's locker and then he re-secured the locker. The only exception was Deputy Wang's uniform shirt, which Sergeant Szerenyi placed into a basket to have dry-cleaned for Deputy Wang for his return to work. Sergeant Szerenyi stated that he did not wear gloves when handling any of Deputy Wang's equipment items due to the fact that the San Mateo County Crime Lab had photographed all of the equipment and had released it to Sergeant Trickett.

On October 10, 2018, I spoke with San Mateo County Sheriff's Office Sergeant Jacob Trickett regarding the chain of custody of Deputy Wang's uniform and equipment. The following is a summary of my conversation with Sergeant Trickett:

Sergeant Trickett stated that he arrived at the scene of the incident in Millbrae on October 3, 2018. Sergeant Trickett arrived and noticed that Deputy Joshua Wang had a facial injury and he made sure that Deputy Wang received medical attention from EMS personnel on scene. Prior to EMS personnel transporting Deputy Wang to the hospital, they informed Sergeant Trickett that they needed to turn over Deputy Wang's firearm and duty belt to someone. Sergeant Trickett took possession of Deputy Wang's duty belt, which contained his duty weapon, as well as Deputy Wang's uniform shirt and inner ballistic vest.

Sergeant Trickett made Deputy Wang's Glock firearm safe by removing the magazine and clearing the unspent cartridge from the chamber. Sergeant Trickett was not wearing gloves at that time. Sergeant Trickett secured all of Deputy Wang's uniform and equipment items in the rear cargo locker of Patrol Vehicle #503, his assigned patrol vehicle. Sergeant Trickett locked and secured his vehicle and he stated that no other personnel had access to his locked patrol vehicle.

**CONTROLLED DOCUMENT**

Prepared By:  
80202 MASSEY, BILL

Date:  
10/11/2018

Approved By:  
80240 WARREN, JOHN

Date:  
12/17/2018



Later during the evening time on October 3, 2018, Sergeant Trickett opened the rear of his patrol vehicle and allowed members of the San Mateo County Crime Laboratory and an Inspector with the San Mateo County District Attorney's Office, Bureau of Investigations to examine and photograph Deputy Wang's uniform and equipment. (I personally observed Crime Lab Criminalists Anthony Delmonico and Cindy Anzalone, as well as DA Inspector Greg Giguere wearing gloves when they were taking photos and examining Deputy Wang's uniform and equipment.)

Sergeant Trickett was provided with Deputy Wang's uniform shirt, ballistic vest and duty belt back once the San Mateo County Crime Lab was done examining and photographing the items. The San Mateo County Crime Lab Criminalists informed Sergeant Trickett that they were done examining and photographing the uniform and equipment and that the items would not be collected as evidence. Sergeant Trickett transported the items to the Millbrae Substation and provided them personally to San Mateo County Sheriff's Office Sergeant Szabolcs Szerenyi. Sergeant Trickett stated that he was not wearing gloves when he first handled Deputy Wang's uniform and equipment and he was not wearing gloves when he turned over the items to Sergeant Szerenyi.

On October 11, 2018, I released Deputy Wang's long sleeve uniform shirt, his inner ballistic vest with attached earpiece and the 52 loose (9mm) rounds from Deputy Wang's Glock firearm and magazines to San Mateo County Sheriff's Office Professional Standards Sergeant Jon Sebring.

**Disposition:**

Attach to Original Report

**CONTROLLED DOCUMENT**

Prepared By:  
80202 MASSEY, BILL

Date:  
10/11/2018

Approved By:  
80240 WARREN, JOHN

Date:  
12/17/2018



**Investigation:**

On October 3, 2018 I was assigned as the primary investigator for the San Mateo County District Attorney's Office investigation into an Officer Involved Critical Incident (OICI) involving deputies from the San Mateo County Sheriff's Office.

On October 4, 2018 I conducted an interview with Sergeant Dave Weidner of the San Mateo County Sheriff's Office. Sergeant Weidner was one of five (5) deputies involved in a use of force incident which included the deployment of a Taser and the use of pepper spray. The subject of the use of force, deceased subject Chinedu Okobi was later pronounced deceased at Mills-Peninsula Hospital. This incident occurred in the 1400 block of El Camino Real in the City of Millbrae. The interview with Sergeant Weidner was conducted at the San Mateo County District Attorney's Office and was documented through both audio and video recording. Also present during the interview was attorney Sarah Burdick from Rains Lucia Stern, PC. During the interview, I confirmed with Sergeant Weidner that he was providing a voluntary statement to the District Attorney's Office and that he had not been ordered to provide a statement by any members of the San Mateo County Sheriff's Office. Prior to the beginning of the interview, I met with Sarah Burdick who advised me that Sergeant Weidner wanted to provide an initial statement based upon his own memories and perceptions of the events of the incident without reviewing any Mobile Audio Video (MAV) footage or civilian video footage. Based upon this request, Sergeant Weidner did not view any video footage of the incident until after the completion of our interview.

**Interview with Sergeant Dave Weidner (paraphrased and not verbatim):**

Sergeant Weidner stated he has worked for the San Mateo County Sheriff's Office for approximately 18 years. Sergeant Weidner began his career at the Sheriff's Office as a Correctional Officer and served in that capacity for approximately one and a half (1.5) years before being promoted to the position of Deputy Sheriff. Prior to starting his employment with the San Mateo County Sheriff's Office, Sergeant Weidner said he worked as a reserve police officer with the South San Francisco Police Department and was also a contractor working building security with the United States Department of State. Sergeant Weidner advised me that he is currently a sergeant assigned to the Millbrae Patrol Bureau and was promoted to sergeant approximately two (2) years ago. Sergeant Weidner told me he had spent approximately ten (10) years of his career at the Sheriff's Office assigned to working uniformed patrol. Sergeant Weidner said he was assigned to the Millbrae Patrol Bureau as a patrol deputy for approximately three (3) years before being promoted to Sergeant and had recently been assigned back to the Millbrae Patrol Bureau as a sergeant in March of 2018.

Sergeant Weidner said October 3, 2018 was a normal scheduled shift and that he is currently assigned to day shift, working a twelve (12) hour shift from 5:00 AM to 5:00 PM each day. Sergeant Weidner explained he works a rotating schedule and does not have fixed days off. Sergeant Weidner explained his shift on October 3, 2018 had either been his seventh (7<sup>th</sup>) or eight (8<sup>th</sup>) straight day of working. Sergeant Weidner explained to me that the Sheriff's Office is currently short-staffed which has resulted in the need for a great deal of overtime to be worked to fill the void in staffing. Sergeant Weidner

**CONTROLLED DOCUMENT**

Prepared By:  
80205 DRAPER, JAMIE

Date:  
10/12/2018

Approved By:  
80240 WARREN, JOHN

Date:  
12/18/2018





informed me that October 3, 2018 was the first day of his regularly scheduled work week and he had worked a 7:00 AM to 5:00 PM overtime shift in the Transportation Unit on October 2, 2018.

Sergeant Weidner stated he arrived at work on October 3, 2018 at approximately 4:45 AM to relieve the night shift sergeant. Sergeant Weidner explained to me that the Sheriff's Office assigns one sergeant per shift to each of the three patrol bureaus on the bayside of the peninsula (Millbrae, San Carlos and Redwood City) so he was the only sergeant working the Millbrae Patrol Bureau during his shift hours on October 3, 2018. Sergeant Weidner further explained the coverage area for the Millbrae Patrol Bureau includes all unincorporated areas on the bayside of San Mateo County from Highway 92 in San Mateo, north to the county limits at the San Francisco border as well as the entire City of Millbrae. As the patrol sergeant working out of the Millbrae Patrol Bureau, Sergeant Weidner explained his area of responsibility on his shift is the entire North County area he described previously. Sergeant Weidner told me there is no Lieutenant assigned to the Millbrae Patrol Bureau, as such his direct supervisor for his shift was Captain Paul Kunkel, who is the commander in-charge of the Millbrae Patrol Bureau.

Sergeant Weidner stated he was wearing a standard wool uniform which he described as fully identifiable as a police uniform with Sheriff's Office patches on the shoulders and his "chevrons" identifying him as a sergeant on the sleeves. Sergeant Weidner stated he was wearing an outer ballistic vest carrier outside of his uniform. Sergeant Weidner described the items he carried on his outer vest carrier as an ASP (collapsible baton), pepper spray, a police radio and a utility pouch containing a back-up firearm. Sergeant Weidner described the items he carried on his duty belt as his duty firearm on his right hip, a Taser on his left hip, as well as a tourniquet and key ring on the front area of his belt.

Sergeant Weidner said he was driving a Ford Explorer Sheriff's Office vehicle which was fully outfitted with Sheriff's Office markings, a light bar and operational Mobile Audio Video (MAV) equipment. Sergeant Weidner stated the MAV equipment also included a portable microphone, which he was wearing clipped on his vest. He believed the MAV would have captured all the audio occurring at the time of the incident and in the aftermath of the incident. Sergeant Weidner described the procedure for utilizing the MAV equipment to me and explained that at the beginning of the shift, the portable microphone would be removed from a charger inside the vehicle, activated and placed on either the uniform or outer vest carrier. Sergeant Weidner explained that upon activating the front facing emergency light bar equipment, the MAV will turn on and the portable recorder will activate which will both then begin recording. Sergeant Weidner stated all the equipment in his vehicle was properly functioning at the time of the incident as was all of his equipment on his person.

I asked Sergeant Weidner if he received a full night's sleep prior to beginning his shift on October 3, 2018. Sergeant Weidner said he typically goes to sleep at 8:15 PM as he has to wake up by 3:20 AM to get to the Millbrae Patrol Bureau by 5:00 AM. Sergeant Weidner confirmed he followed this same sleeping pattern the night before the patrol shift in question. Sergeant Weidner stated he felt both "fine" and "normal" at the beginning of his shift and was not feeling either under the weather or sick. Sergeant

**CONTROLLED DOCUMENT**

<b>Prepared By:</b> 80205 DRAPER, JAMIE	<b>Date:</b> 10/12/2018	<b>Approved By:</b> 80240 WARREN, JOHN	<b>Date:</b> 12/18/2018
--	----------------------------	---	----------------------------



Weidner described his off hours after his shift on October 2, 2018 as uneventful and described his evening as spending time with his wife, smoking a cigar and preparing food for the next day. Sergeant Weidner said he did not consume any alcohol the evening before his shift.

Sergeant Weidner discussed his activity earlier in his shift on October 3, 2018. Sergeant Weidner described three (3) calls he responded to earlier in the shift, all of which also involved Deputy Bryan Watt. Sergeant Weidner described the first call as a call for service in which they were dispatched to a transient female walking down the street who appeared to need assistance. Sergeant Weidner initially described the female as "combative" with the other deputies; however as I questioned him further he described her as being "argumentative" and attempting to "pull away" from the deputies as they attempted to detain her and attempt to provide her assistance. Sergeant Weidner said the subject was detained in handcuffs, for both her safety and the safety of the deputies, but was ultimately released at the scene. Sergeant Weidner described the second call as a self-initiated contact by Deputy Watt in which he contacted a transient subject on the platform at the Millbrae BART station. Sergeant Weidner said the transient subject began to assault Deputy Watt and Deputy Watt had to call for "code-3 cover" which resulted in Sergeant Weidner responding to the scene. Sergeant Weidner said the subject was subdued by responding officers and was found to have outstanding warrants out of multiple jurisdictions. Sergeant Weidner said the subject was already down on the ground and detained in handcuffs by the time he arrived on the platform so he was not involved in the physical act of detaining the subject. Sergeant Weidner described the third call as him having to respond to a traffic enforcement stop conducted by Deputy Watt in which the driver of the vehicle was refusing to sign a citation. Sergeant Weidner said he responded and was able to convince the subject to sign the citation without incident.

I asked Sergeant Weidner to walk me through the incident which occurred in the 1400 block of El Camino Real on October 3, 2018. I asked Sergeant Weidner to start with the point he first became aware of the radio traffic up to the point he was relieved at the scene. Sergeant Weidner told me he was in his office at the Millbrae Police Substation doing administrative work when he heard Deputy Josh Wang broadcast over the radio that he either was attempting to make a pedestrian stop or would "be out" with somebody. Sergeant Weidner then recalled Deputy Wang stating over the radio the subject had run from him and was now running in traffic. Sergeant Weidner said he started to respond from the station with Deputies Alyssa Lorenzatti, Bryan Watt and John DeMartini who had all been at the station finishing their lunch. Sergeant Weidner explained that as he was getting up out of his chair to begin heading toward his patrol vehicle, he heard Deputy Wang broadcast a request for "code 3 cover" over the radio. Sergeant Weidner recalled hearing an additional broadcast, regarding the subject running in and out of traffic, while he and the other units were on their way to the location.

Sergeant Weidner said upon arrival on scene, he drove his vehicle north in the southbound lanes of traffic with the intent to position his vehicle in a manner which would allow his MAV camera the best angle to capture the incident on video. Sergeant Weidner said his vision of what was occurring was

**CONTROLLED DOCUMENT**

Prepared By: 80205 DRAPER, JAMIE	Date: 10/12/2018	Approved By: 80240 WARREN, JOHN	Date: 12/18/2018
-------------------------------------	---------------------	------------------------------------	---------------------



initially obscured by a light pole; however he could see a subject he identified as a black male adult whom deputies were attempting to contact. Upon first seeing the subject, Sergeant Weidner said he observed the subject to be holding his hands straight up in the air while Deputy Wang approach the subject from behind. Sergeant Weidner said he thought Deputy Wang would be able to grab the subject's arm and place him into handcuffs and thought the subject would be compliant based upon the fact the subject was holding his hands up. Sergeant Weidner said he then saw the subject pull his arms down, turn and possibly push Deputy Wang.

Sergeant Weidner said he saw Deputy Wang draw and deploy is Taser at the subject. Sergeant Weidner explained that he could see Deputy Wang had gotten an effective Taser deployment and saw the subject stagger and fall over backwards. Sergeant Weidner added that he is a Taser instructor for the Sheriff's Office and he was focusing on both the subject and on Deputy Wang's trigger finger to make sure he was not continuing to press down on the trigger. He knew that continuing to depress the trigger would cause the Taser to continue to be active. Sergeant Weidner said he noted the location of the two (2) Taser probes in the subject's body and indicated one probe was in the subject's right forearm and the second was in the subject's torso on the right side of the subject's body.

Sergeant Weidner said once the subject fell to the ground on his back, he was able to see the subject appeared to be under the influence of a controlled substance. Sergeant Weidner based this observation on the fact the subject was staring straight into the sky and was "talking to God". Sergeant Weidner said he had personally experienced being "tased" as part of his instructor training and based upon that experience, he knows the only physical reaction possible is either screaming or being totally quiet while the device is actively deploying a shock. Sergeant Weidner said in his experience, he believed the subject would have had to be under the influence of either PCP or "bath salts" to be able to talk through the pain of the Taser deployment. Sergeant Weidner said he moved to grab the subject's arm at the culmination of the five (5) second long deployment to tried and roll the subject over, but the subject pulled away from him. Sergeant Weidner stated, "He pulled away like I wasn't even there" and said the subject pulled him off balance, which forced him to let go of the subject because he feared falling onto the Taser wires and getting hit with the next activation of the Taser.

Sergeant Weidner said the subject then "leapt up" and that as soon he was up, Deputy Wang activated the Taser for a second five (5) second long deployment. Sergeant Weidner said this caused the subject to fall back to the ground again where he and the other deputies again tried to grab the subject and detain him; however the subject continued to pull away from them because "he was way too strong". Sergeant Weidner said he noted at this point in the incident that one of the Taser wires had broken, which he knew would render the Taser ineffective. Sergeant Weidner said the subject then got back up a second time and started to run diagonally across the roadway into the northbound lanes of traffic. Sergeant Weidner identified Deputies Josh Wang, Bryan Watt, Alyssa Lorenzatti and John DeMartini as all being present by this point in the incident and all following the subject across the roadway to try and get him into custody. Sergeant Weidner said the subject was yelling something "incoherent" and "something

**CONTROLLED DOCUMENT**

Prepared By:  
80205 DRAPER, JAMIE

Date:  
10/12/2018

Approved By:  
80240 WARREN, JOHN

Date:  
12/18/2018





about God”.

Sergeant Weidner said he saw Deputy Wang deploy his ASP, but was unsure if Deputy Wang was able to make contact with the subject when he swung the ASP at him. Sergeant Weidner said he knew that Deputy Wang had been struck by the subject because he saw Deputy Wang’s ASP and Taser “literally fly through the air”. Sergeant Weidner said he and the other deputies managed to surround the subject as the he saw the subject lowered his center of gravity and “basically linebacker tackle Josh” (Deputy Wang). Sergeant Weidner saw the subject use both hands to grab toward Deputy Wang’s legs in an attempt to pull Deputy Wang toward him and pull him off balance in an effort to “take Josh to his back”. Sergeant Weidner said he noted at this point that the subject had grabbed a hold of Deputy Wang’s firearm and was worried they were going to get into an Officer Involved Shooting. Sergeant Weidner told me “we had literally escalated through our entire use of force” and noted the use of and failure of verbal commands, Taser deployment, the baton, and pepper spray; however Sergeant Weidner did then correct himself and properly noted that pepper spray had not yet been deployed in the incident.

Sergeant Weidner noted that the subject then went to the ground; however he was unsure how the subject went down. Sergeant Weidner speculated that the subject may have tripped but stated he was unsure. Sergeant Weidner said once the subject was on the ground, he instructed the other deputies to “get on top of him” with the thought that they would be able to control the subject and try and get more deputies on scene to assist them. Sergeant Weidner indicated he again asked for “code 3 cover” to get additional deputies to the scene. Sergeant Weidner told me that Deputy DeMartini was positioned at the subject’s feet, Deputy Lorenzatti was at the subject’s legs and he was trying to gain control of the subject’s right arm, which he noted still had the Taser probe embedded in it. Sergeant Weidner said the subject was bleeding “pretty profusely” from the area of the probe which caused Sergeant Weidner’s hands to keep slipping off of the subject.

Sergeant Weidner said he was later told it was Deputy Wang who deployed the pepper spray at that point in the struggle; however he did not see him do it. Sergeant Weidner speculated the pepper spray was possibly directed upward at the subject’s face while he was in a somewhat prone position on the ground which cause the spray to miss the subject completely and instead strike Deputy Watt, Deputy Lorenzatti and Sergeant Weidner. Sergeant Weidner said Deputy Watt took a direct “shot to the face” and Deputy Lorenzatti took a direct hit. Sergeant Weidner added that he received the splash back in his face from the pepper spray as well. Sergeant Weidner said Deputy Watt was completely incapacitated from the effects of the pepper spray and Sergeant Weidner said he knew there was no way Deputy Watt could continue to assist them because he noted Deputy Watt could not breathe and had to “back off”. Sergeant Weidner recalled Deputy Lorenzatti also having similar difficulty and believed she said something to the effect of, “Sarge, I can’t breathe” and “I can’t see, Sarge”. Sergeant Weidner said he responded by telling Deputy Lorenzatti to “hang in there” and to “stay in the fight”.

Sergeant Weidner said he was able to get the subject’s arm out from under him and yelled out that he

**CONTROLLED DOCUMENT**

Prepared By: 80205 DRAPER, JAMIE	Date: 10/12/2018	Approved By: 80240 WARREN, JOHN	Date: 12/18/2018
-------------------------------------	---------------------	------------------------------------	---------------------



needed handcuffs at which point someone placed one pair of handcuffs on one of the subject's wrists. Sergeant Weidner yelled out for a second pair of handcuffs (to link together) because he knew (based on the subject's large size) "there was no way we were getting his hands behind his back with one pair". Sergeant Weidner said someone was ultimately able to place a second set of handcuffs on the subject but he could not see who it was, but believed it was Deputy Wang who was able to get the subject's other arm behind the subject's back when they were finally able to get the subject handcuffed.

Sergeant Weidner said once the subject was successfully handcuffed, he immediately became concerned about the risk for positional asphyxia since they had physically been on top of the subject. Sergeant Weidner directed the other deputies to get off the subject and assist him in getting the subject into a sitting position. Sergeant Weidner estimated he had the subject sitting up within approximately ten (10) seconds of being handcuffed. Sergeant Weidner said he checked for and located a pulse on the subject once he was in a seated position and noted the subject was initially "not responsive but all the sudden he woke up" and was actively looking around. Sergeant Weidner said he then had the Fire Department and medical personnel, who had been staging nearby, come into the scene. Sergeant Weidner explained that he had three (3) deputies who had been hurt. He wanted to start following protocol and setting up a crime scene so he requested Captain Paul Kunkel respond and assist in controlling the scene.

Sergeant Weidner said he believed it was at this point that he began directing the deputies on the scene to start obtaining witness statements and noted that Deputy Josh Wang was bleeding "pretty profusely from the face". Sergeant Weidner added that he wanted to get medical treatment for Deputy Wang right away because he did not know the severity of Deputy Wang's injuries. Sergeant Weidner reported that a Millbrae "city worker" was on the scene helping Deputy Watt flush his eyes out with water so he began attending to Deputy Lorenzatti while also trying to monitor the now detained subject. Sergeant Weidner recalled that he was focused on trying to get the crime scene set up and get the subject medical attention right away. Sergeant Weidner recalled seeing the paramedics tending to the subject, and the subject being alert and looking around, and "then all the sudden he just coded". Sergeant Weidner recalled one paramedic yelling to the Fire Captain, that he needed to get a heart monitor on the subject, but saw the Captain did not hear the request so Sergeant Weidner went to the Captain and passed on the request. Sergeant Weidner said it was at this point that all the medical personnel on scene then began working (treatment) on the subject and he began activating the Officer Involved Critical Incident Protocol.

I asked Sergeant Weidner if he ever heard Deputy Wang put out a description of the subject he was attempting to contact, but Sergeant Weidner said he did not recall a description of the subject ever being broadcast on the radio. I asked Sergeant Weidner how he knew the person they attempted to detain was the subject Deputy Wang was trying to contact. Sergeant Weidner explained to me that when he arrived on scene, he saw Deputy Wang pulling up behind the subject and that the subject with his hands up was the only person he saw on the sidewalk between him and Deputy Wang. Sergeant Weidner also cited the fact the subject had his hands held up and the lack of other persons around as how he deduced it was the right subject.

**CONTROLLED DOCUMENT**

<b>Prepared By:</b> 80205 DRAPER, JAMIE	<b>Date:</b> 10/12/2018	<b>Approved By:</b> 80240 WARREN, JOHN	<b>Date:</b> 12/18/2018
--	----------------------------	---	----------------------------



CONTROLLED DOCUMENT

I asked Sergeant Weidner what his mindset was as he arrived on scene and saw the other deputies attempting to detain the subject. Sergeant Weidner noted that as a supervisor, he wanted to be able to let his people "do their job" and be able to help them, but not try to take over as that may cause them to back off and expect him to handle the situation. Sergeant Weidner described it as "a fine line" and situations like these would require him to "know" his "troops" and assess the situation to determine when intervention as a supervisor was necessary. Sergeant Weidner said he decided his deputies were doing "just fine" when he first arrived as they were giving commands and were not rushing to try and hit the subject with a baton. Sergeant Weidner said he noted his deputies were going through the use of force continuum and expressed his opinion that "they exercised great restraint". Sergeant Weidner said he did eventually give commands to the subject when the subject was on the ground the first time. Sergeant Weidner said he was attempting to end the situation by trying to grab the subject and get him to roll over; however Sergeant Weidner told me "that was not gonna happen. This guy had super human strength". I asked Sergeant Weidner what commands he was giving and he recalled telling the subject "stop resisting" and "roll-over on your stomach". Sergeant Weidner talked about his experiences with the Taser and noted that typically when a person is hit with the Taser from the front, they will fall over on their back "like a board" and when they are told to roll over, they will do it quickly as they do not want to receive a second activation.

Sergeant Weidner was unable to provide specific information regarding what the subject was saying prior to the first Taser deployment. He estimated he was "a good twenty feet away" when Deputy Wang first deployed the Taser. Sergeant Weidner explained that he quickly approached and covered the distance when he saw the subject go down from the Taser deployment. From this position he was able to see the subject was laying on his back with his arms tensed up with his hands roughly at the same level as the subject's head. Sergeant Weidner reported the subject had what he would describe as a "thousand yard stare on his face" and was talking straight up toward the sky "like we weren't even there". Sergeant Weidner could not recall precisely what the subject was saying only that it was something similar to "something God" and he was just "going on". Sergeant Weidner did recall the subject at one point saying "What did I do?" but that was after they had already moved over to the northbound lanes of traffic, just prior to the point where he "assaulted Josh". Sergeant Weidner said "it was almost as if he had a second of clarity and then he just kept attacking". Sergeant Weidner said the whole time the incident was going on, all the deputies were telling the subject to "stop resisting" and "stop fighting". Sergeant Weidner added "we were trying to de-escalate it, but it wasn't going to happen".

I asked Sergeant Weidner if there were any other indicators of the subject being under the influence other than his strength and the "thousand yard stare". Sergeant Weidner told me the subject was "a very big guy" and estimated the subject to be approximately six (6) foot or more tall and in the area of 300 to 320 pounds. Sergeant Weidner noted the subject significantly outweighed him and his deputies. Sergeant Weidner also added his opinion the subject was under the influence of either PCP or "bath salts" given his experience in having seen people under the influence of both substances and said adding these

Prepared By: 80205 DRAPER, JAMIE

Date: 10/12/2018

Approved By: 80240 WARREN, JOHN

Date: 12/18/2018





**CONTROLLED DOCUMENT**

substances with the subject's physical stature meant there "was no stopping a man that size". Sergeant Weidner said the key indicator to him that the subject was under the influence of PCP or "bath salts" was the fact the subject was talking through the Taser deployment and said "you can't do that, okay? That does not happen".

I asked Sergeant Weidner whether he wore any corrective lenses and he told me he does use reading glasses, but only needs them for reading and has no other vision problems. Sergeant Weidner stated he had a clear view of what was occurring during the incident and that the lighting conditions were good due to it being daylight hours at the time the incident took place. Sergeant Weidner did acknowledge that the exposure to pepper spray did effect his ability to see everything that was going on once the subject was on the ground the final time.

I asked Sergeant Weidner if he ever transitioned to or deployed any of the less-lethal weapons available to him during the incident. Sergeant Weidner stated he did not utilize any of his less-lethal options during the incident and added he already knew one Taser had been ineffective in incapacitating the subject and knew his Taser would have had the same effect. Sergeant Weidner stated he knew his pepper spray would also be ineffective since it had already been deployed and was not effective. Sergeant Weidner also explained his belief the baton or ASP would also not be effective on a person of that size. Sergeant Weidner said he knew the next level of escalation was deadly force and he was trying to avoid that when the subject was taken to the ground and he was instructing the other deputies to "get on top of him". Sergeant Weidner clarified that he did have his Taser out briefly when he first arrived on scene, but when he saw Deputy Wang's Taser was not working on the subject, he put his away. Sergeant Weidner explained to me that as a Taser instructor, he instructs Deputies that if one Taser is not working on a subject, the other will not work either and for them not to deploy it in those situations. I asked Sergeant Weidner about the use of the carotid restraint and whether he or any of the deputies involved deployed that technique in their attempts to subdue the subject. Sergeant Weidner stated he did not use the carotid and from his vantage point, he was able to see each of the other deputies and he was confident none of them used the carotid restraint on the subject.

I asked Sergeant Weidner about the involvement of Community Service Officer (CSO) Joey Gonzales at the scene and Sergeant Weidner confirmed CSO Gonzales' presence at the tail end of the incident and believed it was CSO Gonzales who handed him a set of handcuffs at one point during the struggle to get the subject detained. Sergeant Weidner said he recalled seeing a "flash of light blue", which he believed to be the light blue uniform worn by CSO Gonzales, which was why he believed it was CSO Gonzales who handed him the handcuffs. Sergeant Weidner said his vision was blurred from the effects of the pepper spray by that point and he was struggling to keep his eyes open so he could not be positive it was CSO Gonzales. I asked Sergeant Weidner if this was CSO Gonzales' only involvement in in the incident and Sergeant Weidner said he believed it was. Sergeant Weidner added that he had been yelling out for a pair of handcuffs at the time and thought CSO Gonzales ran over to provide them to him. Sergeant Weidner said he did not know CSO Gonzales was present at the scene until he handed him the

Prepared By:  
80205 DRAPER, JAMIE

Date:  
10/12/2018

Approved By:  
80240 WARREN, JOHN

Date:  
12/18/2018



handcuffs.

I asked Sergeant Weidner if he had ever seen this subject or had any contact with him prior to the incident on October 3, 2018. Sergeant Weidner stated "I've never seen him before a day in my life" and added "I don't even know his name". I asked Sergeant Weidner if he had any injuries as a result of the incident. Sergeant Weidner indicated he had some soreness in his back and legs from exertion in taking the subject into custody and some residual effects from the pepper spray, but no physical injuries or anything which required medical attention. I noted a scratch on Sergeant Weidner's right hand and asked him if that occurred during the incident and he stated it did; however he was unsure as to how or when exactly he was scratched. I asked Sergeant Weidner if he took any medications which might affect his reactions or abilities to perceive situations and Sergeant Weidner stated he does not take any medications.

Sergeant Weidner told me he has been a member of the Sheriff's Office Range Training staff for approximately ten (10) years and is currently one of the lead firearms instructors for the Sheriff's Office. Sergeant Weidner said he is certified as both a handgun and rifle instructor and as his collateral duties on the range staff, he is both a Taser and an OC (pepper spray) instructor. Sergeant Weidner said he teaches courses on these topics to new deputies and certifies the deputies in the use of the Taser and pepper spray. Sergeant Weidner said the training class put on by the Sheriff's Office for certification in the use of the Taser is an eight (8) hour course which includes instruction on how to operate the Taser, policies specific to Taser deployment and liability related topics. Sergeant Weidner said he attended a two (2) day class put on by the Alameda County Sheriff's Office to become certified as a Taser instructor. Sergeant Weidner described the topics of the course as being very similar to the class he puts on for new deputies and explained that during the period he went through the course, instructors were required to take a full five (5) second deployment from the Taser before they could be certified; however that is no longer a requirement of the course. Sergeant Weidner stated he was given the option of having the Taser prongs attached to his clothing with clips or to be shot with the prongs. Sergeant Weidner said he chose to be shot with the Taser prongs in a real deployment to experience the affects. Sergeant Weidner added that he did not recommend anyone else doing the same and said he has since refused to volunteer for receiving any Taser "hits" during his recertification course.

Sergeant Weidner stated he is not a trainer in either the ASP or in defensive tactics, but had regularly attended POST mandated perishable skills training in regards to tactical communications, defensive tactics and the ASP. Sergeant Weidner indicated his belief the Sheriff's Office requires deputies to attend defensive tactics training "once a year". In addition to the standard first-aid training he receives from the agency each year, Sergeant Weidner said he also attended an eight (8) hour "Tactical Medical School" put on by the Department of Homeland Security approximately one (1) year ago. Sergeant Weidner said this course primarily covered the use of tourniquets and emergency medicine in the field.

Sergeant Weidner said he has been certified in Crisis Intervention Training (CIT) and has attended the

**CONTROLLED DOCUMENT**

Prepared By:  
80205 DRAPER, JAMIE

Date:  
10/12/2018

Approved By:  
80240 WARREN, JOHN

Date:  
12/18/2018





school twice during his career. Sergeant Weidner added he is familiar with de-escalation and was attempting to de-escalate the situation on October 3, 2018 and trying to prevent the situation from escalating to deadly force. I asked Sergeant Weidner if he had success previously in de-escalating situations utilizing his CIT training and he said "yes, absolutely".

I resumed the interview after a short break and asked Sergeant Weidner some clarifying questions. I asked Sergeant Weidner if he knew the reason deputies were trying to stop the subject. Sergeant Weidner said he did not know the reason for the stop when he responded to the incident until he spoke very briefly with Deputy Wang when Deputy Wang was in an ambulance being prepared to be taken to the hospital. Sergeant Weidner said he did hear Deputy Wang say over the radio the subject was running in and out of traffic and was running from Deputy Wang. I asked Sergeant Weidner why he might want to contact someone under those specific circumstances. Sergeant Weidner explained to me that it sounded to him as if the subject was behaving as if he was under the influence of drugs or alcohol and the subject's running in and out of traffic made him a danger both to members of the public and to himself. Sergeant Weidner added, "no normal person runs in and out of traffic". Sergeant Weidner confirmed the incident occurred on El Camino Real, a busy roadway. Sergeant Weidner added that this specific portion of El Camino Real is a very high traffic area and told me the City of Millbrae constantly has accidents occur where pedestrians are being struck by cars.

Sergeant Weidner said that if he had been the one initially trying to detain the subject, his goal would have been to detain the subject, see if the subject was under the influence of a controlled substance, get the subject medical attention and evaluate the suspect as a possible danger to himself and others and then possibly place him on a mental health hold.

I asked some more questions in regards to when Sergeant Weidner saw the subject grabbing Deputy Wang's firearm. More specifically, I asked him to describe in more detail how the subject was holding or grabbing the firearm. Sergeant Weidner described Deputy Wang as standing straight up and the subject as having bent down and trying to put his shoulder into Deputy Wang's waist. Sergeant Weidner said rather than wrap his hands and arms around Deputy Wang's waist, the subject placed his hand on Deputy Wang's holstered gun. Sergeant Weidner described the subject as grasping the holster and the upper portion of the firearm, where it extended out above the holster. Sergeant Weidner said he could not say for sure if the subject attempted to pull on the holster and firearm or not.

I asked Sergeant Weidner if he was able to see if the Taser probe was still in the subject's forearm when he was trying to place the subject in handcuffs towards the end of the altercation. Sergeant Weidner said he could see the probe was still in the subject's arm and speculated the probe was what cause the scratch/cut to Sergeant Weidner's hand as his hand kept slipping on the blood in the location of the probe.

I asked Sergeant Weidner to walk me through what emotions he was feeling and what concerns he had

CONTROLLED DOCUMENT

Prepared By: 80205 DRAPER, JAMIE	Date: 10/12/2018	Approved By: 80240 WARREN, JOHN	Date: 12/18/2018
-------------------------------------	---------------------	------------------------------------	---------------------



CONTROLLED DOCUMENT

during the incident. Sergeant Weidner said his only real concern was the safety of his deputies and he wanted to make sure they were okay. Sergeant Weidner said he feared he and his deputies were going to be in an officer involved shooting because "we had done everything possible to try and restrain this guy. We used every escalation of force possible. Every de-escalation of force possible. I knew Deputy Watt was completely incapacitated from pepper spray. I knew Deputy Lorenzatti was incapacitated because she kept telling me she couldn't see. I was probably about thirty (30) percent incapacitated, but I could still force open one of my eyes. Um, so I knew that if this guy got up off the ground, I was going to have to shoot him. So we were doing everything we could to try and avoid a deadly force situation".

At the culmination, I allowed Sarah Burdick to ask any questions she might have for Sergeant Weidner. Sarah Burdick asked Sergeant Weidner if the fact the subject was able to get up "almost immediately" after the first Taser deployment indicated anything to him. Sergeant Weidner said this was what first indicated to him the subject was under the influence of a controlled substance. Sergeant Weidner said that from his own experience with having felt the effect of the Taser he knew "your muscles lock up" and indicated that upon the five (5) second activation ending, a person's body will relax and they will be feeling relief the activation is over. Sergeant Weidner said the subject's ability to immediately jump up at the end of the five (5) second deployment indicated to him "he's got drug on-board". Sergeant Weidner went on to say the biggest indicators to him that the subject was likely on either PCP or "bath salts" was the fact it appeared to him the subject was not experiencing any pain as well as "his literally super-human strength". I asked Sergeant Weidner if he has ever attended formal training in regards to the recognition of persons under the influence of controlled substance. Sergeant Weidner stated he has taken multiple courses in his career to recognize controlled substance influence and his experience in the jail working as an "intake deputy" would frequently expose him to numerous people coming in under the influence. Sergeant Weidner indicated he also has had experience in contacting, evaluating and arresting persons who are under the influence during his career.

I asked Sergeant Weidner based upon his experience as a Taser instructor, if mental health conditions can also play a factor in the effectiveness of the Taser. Sergeant Weidner told me mental health can be a factor, but several of the indicators he observed with this specific subject led him to believe the subject's actions were due to being under the influence and not due to mental health issues.

Sarah Burdick asked Sergeant Weidner a final series of questions regarding whether or not Sergeant Weidner had seen any MAV footage or news footage taken by bystanders of this incident prior to our interview and Sergeant Weidner stated he had not viewed any video of the incident.

**DISPOSITION:**

Attach to original report.

Prepared By: 80205 DRAPER, JAMIE	Date: 10/12/2018	Approved By: 80240 WARREN, JOHN	Date: 12/18/2018
-------------------------------------	---------------------	------------------------------------	---------------------



**SAN MATEO COUNTY DISTRICT ATTORNEY'S OFFICE**

Page 12

400 COUNTY CENTER, 3RD FLOOR REDWOOD CITY, CA 94063 650-363-4636

SUPPLEMENT 9 - Interview of Sergeant Dave Weidner

18-1003-02

**CONTROLLED DOCUMENT**

Prepared By:

80205 DRAPER, JAMIE

Date:

10/12/2018

Approved By:

80240 WARREN, JOHN

Date:

12/18/2018

**INTERVIEW WITH SGT. DAVID WEIDNER**

**Q=Insp. Jamie Draper**

**A=Sgt. David Weidner**

**A1=Sarah Burdick**

1  
2  
3  
4  
5  
6  
7  
8  
9  
10  
11  
12  
13  
14  
15  
16  
17  
18  
19  
20  
21  
22  
23  
24  
25  
26  
27  
28  
29  
30  
31  
32  
33  
34  
35  
36  
37  
38  
39  
40  
41  
42  
43  
44  
45

Man: Hey - hey, (Dave), yeah, just - just go in the hallway then we'll, uh, and then and then they'll come (unintelligible).

A1: Oh, perfect. Okay, that's the closest one?

Man: (Unintelligible).

A1: Yeah.

Man: (Unintelligible).

A1: Yeah.

A: Okay.

Q: Well not actually. All right. Okay. Dave, we have met before but, Jamie.

A: Dave Weidner. I've seen you around.

Q: Yeah.

A1: And then I have a card officially for the file.

Q: Well if we're getting all official.

A1: There you go - well there you go.

Q: Um, some of the time while I'm talking to you about some of the stuff - just going to be going off of a little bit of a checklist here. So if I'm not necessarily, like, making eye contact with you and looking and stuff while I'm asking questions it's probably 'cause I'm making sure that I covered everything that I need to...

A: sure.

Q: ...to cover. So, don't feel like I'm ignoring you, um, and don't feel like you need - assume you had to stop talking, either, you know what I mean?

A: Okay.

46  
47 Q: Yeah, sometimes aren't sure and they kinda shut down for a second and I just  
48 wanna make sure that we're good with all that. Um, start with, um, how long  
49 have you been employed as a police officer?  
50  
51 A: I've worked for the Sheriff's Office for 18 years.  
52  
53 Q: Okay. And you are currently a sergeant? A...  
54  
55 A: Yes, I'm a sergeant assigned to the patrol bureau up in Millbrae.  
56  
57 Q: And how long have you been a sergeant?  
58  
59 A: Little over two years 'cause I just got off probation.  
60  
61 Q: Okay. And you said employed by the Sheriff's Office. Was that always as a  
62 peace officer or was it also as a correctional officer?  
63  
64 A: I started as a correctional officer and I got promoted to deputy sheriff about a  
65 year and a half after.  
66  
67 Q: Okay. So, about the first year and a half of that 18 years was...  
68  
69 A: Mm-hm.  
70  
71 Q: ...was as a C.O. Okay.  
72  
73 A: But I also have four years ex- uh, as a reserve police officer with the city of  
74 South San Francisco.  
75  
76 Q: Okay. Um, any military background?  
77  
78 A: No.  
79  
80 Q: No? Okay. Any other law enforcement type, like even security guard or loss  
81 prevention or anything like that?  
82  
83 A: Uh, I worked as a - prior to the Sheriff's Office my full time job was I was a  
84 contractor with the, uh, State Department. And basically we were just working  
85 the checkpoints.  
86  
87 Q: Um, at the buildings?  
88  
89 A: At the, uh, Federal building.  
90



91 Q: Like building security.  
92  
93 A: Yes.  
94  
95 Q: Okay. Was this your normal shift that you were working yesterday?  
96  
97 A: Yes.  
98  
99 Q: Okay, so it wasn't an overtime shift or a trade with anybody else?  
100  
101 A: No.  
102  
103 Q: Okay. And what time did your shift begin?  
104  
105 A: Uh, the sergeants start at 5:00 am. We work 5:00 to 5:00.  
106  
107 Q: Okay. And is it, um, rotating days off or...  
108  
109 A: Yes, we're - I'm on Team One. It's a two on two off schedule. And then every  
110 other weekend is a three day weekend.  
111  
112 Q: Okay. And how many days had you been working this week so far - at the  
113 time?  
114  
115 A: Um, I think I was doing seven straight - I think I was - we'd been working a  
116 lot of overtime 'cause we're really shorthanded, so...  
117  
118 Q: Right.  
119  
120 A: I think I could be seven or eight days straight.  
121  
122 Q: Okay.  
123  
124 A: I think.  
125  
126 Q: And so your last shift woulda been the day before...  
127  
128 A: Yes.  
129  
130 Q: ...the incident.  
131  
132 A: I was working the day before. I think I was working in the jail and the day  
133 before that I was working overtime in San Carlos, um, as a patrol sergeant.  
134  
135 Q: Okay. The shift in the jail - the day before this incident...

136  
137 A: Yes.  
138  
139 Q: ...what were your hours that day?  
140  
141 A: Uh, 6:00 to 6:00.  
142  
143 Q: Am to pm?  
144  
145 A: 6:00 am to 6:00 pm.  
146  
147 Q: Okay. So, very similar to your normal hours then?  
148  
149 A: Yes.  
150  
151 Q: Okay.  
152  
153 A: I'm sorry - I worked transported that d- the day before - sorry - transportation.  
154 That was 7:00 to - 7:00 to 5:00.  
155  
156 Q: Okay. 7:00 am to 5:00...  
157  
158 A: Yes.  
159  
160 Q: ...pm? Okay. What time did you get to work yesterday?  
161  
162 A: I arrived at work about 4:40 - 4:45 to relieve the, uh, night shift sergeant - the  
163 graveyard sergeant.  
164  
165 Q: Okay. And is that, um, typically with the Millbrae Bureau that you're assigned  
166 - is that one sergeant on duty typically for the patrol at a time or is there  
167 multiple sergeants working at a time?  
168  
169 A: Well, there's one sergeant per bureau. So, one sergeant in Millbrae, one  
170 sergeant in San Carlos...  
171  
172 Q: Okay.  
173  
174 A: One Sergeant in Redwood City. (Unintelligible).  
175  
176 Q: Okay. So, for your shift you were the sole sergeant for...  
177  
178 A: Yes.  
179  
180 Q: ...Millbrae? Okay. And, does that encompass more area than just Millbrae? Or

181 is it only within the - the Millbrae contract beat?  
182  
183 A: No, it encompasses basically from 92 all the way to San Francisco. My s- I'm  
184 the sergeant responsible for the entire north county.  
185  
186 Q: Okay.  
187  
188 A: And then they have a separate sergeant for the coast.  
189  
190 Q: Okay.  
191  
192 A: So the cut off is San Bruno Mountain or the San Francisco line.  
193  
194 Q: Okay. So, the unincorporated areas in the north?  
195  
196 A: Yes.  
197  
198 Q: Eichler Highlands...  
199  
200 A: Yes.  
201  
202 Q: ...Guadalupe Canyon, that kind of areas?  
203  
204 A: Yes.  
205  
206 Q: Okay.  
207  
208 A: San Bruno Mountain.  
209  
210 Q: Who would have been your direct supervisor yesterday?  
211  
212 A: My direct supervisor would have been Captain Paul Kunkel.  
213  
214 Q: Okay. So, no lieutenant?  
215  
216 A: Yes.  
217  
218 Q: Okay. Is that normal? Or...  
219  
220 A: For the Millbrae Patrol Bureau, yes.  
221  
222 Q: Okay. Um, and how were you dressed for your shift?  
223  
224 A: I was dressed in full uniform. Fully identifiable sheriff, uh, office patches  
225 with, uh, my chevrons identifying me as a sergeant.

226  
227 Q: Yep. And were those BDU style uniforms or the wools...  
228  
229 A: They were the wool style uniforms.  
230  
231 Q: Okay.  
232  
233 A: And with the, uh, we were wearing the exterior vests.  
234  
235 Q: Okay.  
236  
237 A: Which displace all the weight from the waist of the gun belt to the - to the  
238 body...  
239  
240 Q: Okay. Let's talk...  
241  
242 A: ...to reduce back pain.  
243  
244 Q: Let's talk about your outer carrier then. What items do you carry on your  
245 outer carrier?  
246  
247 A: So, the items I have on my outer carrier, um, basically have come off of the  
248 gun belt. I have an ASP on my left side. I have my pepper spray. Um, I have  
249 my radio. I have a utility pouch here and inside my utility pouch is a  
250 secondary gun - a backup gun.  
251  
252 Q: Okay.  
253  
254 A: Um, then I have a notepad with a couple pens. And over here in this pocket I  
255 have the Leatherman tool and a tape recorder.  
256  
257 Q: Okay. And then what items do you carry on your duty belt?  
258  
259 A: Uh, the items I have on my duty belt are my primary firearm. Uh, my Taser  
260 and then I have a tourniquet and then a key ring.  
261  
262 Q: Okay. And you've indicated to me the gun is on your...  
263  
264 A: Right side.  
265  
266 Q: ...strong side - right hand. And your Taser is on your...  
267  
268 A: Support side.  
269  
270 Q: ...weak side, okay. Um, so you completed your shift the day before about 5:00

271 pm working transit. Um, did you get a full night's sleep...  
272  
273 A: Yes.  
274  
275 Q: ...before your next shift? So how many hours do you think?  
276  
277 A: So, I have to get up at 3:20 in the morning to be there at 5:00. So I usually  
278 typically go to bed with lights out about 8:15.  
279  
280 Q: Okay.  
281  
282 A: No later than 8:15.  
283  
284 Q: Okay. Um, and you kinda already said it - but what time do you wake up in  
285 the morning typically?  
286  
287 A: Uh, 3:20.  
288  
289 Q: And that woulda been the case yesterday?  
290  
291 A: Yes.  
292  
293 Q: Oh. Um, how did you feel when you started your shift?  
294  
295 A: Fine, normal, um...  
296  
297 Q: Not under the weather...  
298  
299 A: ...it isn't getting up that early...  
300  
301 Q: No, but...  
302  
303 A: ...in the morning, but...  
304  
305 Q: ...not under the weather or anything like that?  
306  
307 A: No. No, I wasn't sick or anything like that - I felt fine.  
308  
309 Q: And how was your time off between shifts?  
310  
311 A: What do you mean?  
312  
313 Q: How was it? Was it eventful? Was it uneventful?  
314  
315 A: Oh, no, it's uneventful. I just, uh, go home, decompress, you know and have a



316 cigar - hang out with the wife and, uh, prep food for the next day.

317

318 Q: Okay. Um, did you have any alcohol during the off hours?

319

320 A: No - not - not - not that night, no.

321

322 Q: Okay. Um, so you started at 5:00 in the morning.

323

324 A: Yes.

325

326 Q: So, I assume there were quite a few calls for service during that time period.  
327 However as a sergeant you're not typically responding to many calls. Um, did  
328 you respond to some of the calls for service that day?

329

330 A: Yes, that day I did when my team was fully 10-8 in service. I typically will  
331 respond to certain calls, um, depending on what they are. Um, sometimes if  
332 I'm out and about just roaming around, I'll just show up, uh, to cover them,  
333 um, or be involved or I'll respond.

334

335 Q: Okay. And were any of those other calls stressful?

336

337 A: I wouldn't classify 'em as stressful.

338

339 Q: Um, would you classify them as routine?

340

341 A: Um, yeah, I mean I've been on pa- I - prior to becoming promoted to sergeant  
342 I had - I was on s- patrol for ten years.

343

344 Q: Okay.

345

346 A: So, my experience is very different than somebody who has maybe a couple  
347 years on.

348

349 Q: Right.

350

351 A: so, um, so, there's a couple calls I went to with Deputy Watt that day. Uh, first  
352 thing in the morning we got a call of a transient lady walking down the street  
353 that looked like she needed assistance, so we went there. She was kinda  
354 combative, we calmed her down. Um, were able to get her assistance that she  
355 needed. But really she just wanted to get on the BART train and go to  
356 Oakland. Uh, the next call we had after that was, um, we get a lot of transients  
357 that get off at the Millbrae BART station.

358

359 Q: Okay.

360

- 361 A: And they come into our city. The next call after that was, uh, Deputy Watt  
362 contacted a transient at the, uh, BART station who then began to a- assault  
363 him and he called for code three cover. We all responded to that. Uh, once we  
364 subdued the suspect that in that call he had \$20,000 warrant out of our agency  
365 - \$80,000 warrant out of Southern California and a \$5,000 warrant out of So-  
366 uh, San Francisco I think it was. So he was arrested and booked. The call after  
367 that was, um, a gentleman who refused to sign a citation. Um, so I just  
368 responded to that. 'Cause re- I was requested and, uh, I was able to get him to  
369 sign the citation and explain to him, you know, go to court.  
370
- 371 Q: Mm-kay. Um, we'll go backwards to I guess the - the two prior transient  
372 contacts. But we'll start with the earlier one. you remarked...  
373
- 374 A: Yes sir.  
375
- 376 Q: ...about the woman being combative.  
377
- 378 A: Mmm.  
379
- 380 Q: Was she physically combative or argumentative or...  
381
- 382 A: She was argumentative and they - when they tried to detain her to help her,  
383 um, she just tried pulling away from them. She didn't, like, try to hit them or  
384 anything like that.  
385
- 386 Q: Mm-kay. So it was not really a use of force incident? Her...  
387
- 388 A: No, we detained her.  
389
- 390 Q: But...  
391
- 392 A: We detained her and put her in handcuffs for, um, because she, you know, she  
393 was trying to pull away and flail. So for our safety we put her in handcuffs -  
394 yes.  
395
- 396 Q: And that was just done physically hands on as opposed to use of, like, a Taser  
397 or other weapons?  
398
- 399 A: Oh, yeah - yeah.  
400
- 401 Q: Okay. And then the second one - the one that sounds like it was far more...  
402
- 403 A: Mm-hm.  
404
- 405 Q: ...confrontational and more combative. Can you describe what occurred in

406 that? At least from when you were involved?

407

408 A: Well he requested, uh, at the time he contacted and I heard him ca- call on the  
409 radio he - he needed code three cover 'cause the guy was combative with him.  
410 By the time I arrived at the call we, um, it was at the Millbrae, uh, BART  
411 station at the top of the platform. So, as we ran up the stairs they already had  
412 him in - down on the ground in handcuffs.

413

414 Q: So the person had already been detained...

415

416 A: Yeah.

417

418 Q: ...by the time you got there?

419

420 A: By the time I got there, yes, it was over.

421

422 Q: Okay. So it was code four...

423

424 A: Mm-hm. Yes.

425

426 Q: ...at that point? Okay. Um, and so you obviously - you did not really have to  
427 do anything to detain that person yourself?

428

429 A: No, not at all.

430

431 Q: Okay. Mm-kay. Let's talk about the actual call - the - the reason we're here  
432 now.

433

434 A: Sure.

435

436 Q: if you can just kind of walk me through from the beginning when you first  
437 become aware of radio traffic or even with that through to - to the end and,  
438 you know, I'll let you kinda tell the story first. I may have some questions.  
439 But I'm for the most part gonna let you just kinda walk me through everything  
440 that you remember.

441

442 A: Sure, no problem. So...

443

444 A1: I'm sorry, not to interrupt, but before we do that did you want to give him the  
445 modified Beheler advisement?

446

447 Q: Mm-mm.

448

449 A1: No? We don't need that...

450

451 Q: He is free to leave obviously.  
452  
453 A1: Yeah.  
454  
455 Q: This is a voluntary statement. Um, you've spoken with your attorney about  
456 that...  
457  
458 A: Mm-hm.  
459  
460 Q: ...and you're willing to provide this statement voluntarily?  
461  
462 A: Yes, I'm good.  
463  
464 Q: Okay.  
465  
466 A: We're good.  
467  
468 Q: Uh, now if you - and - go ahead and tell me the story.  
469  
470 A: Yeah, all right, no problem. So we had just finished eating lunch together as a  
471 team. Um, and the guys were gonna get back on the street. I went into my  
472 office, I started doing my administrative work. Um, I think I heard him say on  
473 the radio, uh, his call sign was, uh - uh, Boy 62...  
474  
475 Q: And by him we're talking about officer...  
476  
477 A: We're - officer - by - Josh Wang...  
478  
479 Q: Okay.  
480  
481 A: Deputy Josh Wang Um, so Deputy Josh Wang, uh, said he was gonna try to  
482 make a ped stop, where he was gonna be out with somebody. Uh, then he said,  
483 um, he ran from me and now he's running in traffic. Um, so, we all started  
484 responding, uh, 'cause we were concerned that it was probably gonna - it m-  
485 could of escalated and plus this guy's running in traffic so now we have  
486 another s- you know, safety concern. So we arrived on sce- uh, as I was  
487 getting up out of my chair to start walking to my car he requested code 3  
488 cover. So, we all raced out there to the scene, and, uh - uh, he put out on the  
489 radio again, he's running in traffic. Um, so once we got there, um, I purposely  
490 positioned my vehicle - so I pulled into the southbound lanes - I pulled in  
491 opposite direction f- with my MAV video on - 'cause I actually wanted to  
492 capture the incident on, um, on video. When I got there I was obs- um, my  
493 vision was kind of obstructed by the, um, the tel- the light pole right there. But  
494 I could see, um, the black male adult that he was trying to contact. Um, so as I  
495 got out of the car I saw the guy had his hands straight up in the air. So, I

496 figure, um, Deputy Lorenzatti arrived right next to me. Um, Deputy Watt  
497 arrived. I don't know where he parked. Um, but, uh, so I saw Jo- Deputy Josh  
498 Wang approach the suspect. I thought he was just gonna grab his arm, put him  
499 in handcuffs. I thought he was going to be compliant. And what I saw after  
500 that was the guy pulled his arms down turned and I think he pushed Deputy  
501 Wang. And at that point Deputy Wang drew his Taser, uh, and I saw him  
502 deploy the Taser. Um, the suspect then started staggering back. I could tell he  
503 had a good Taser deployment. Um, he start- he staggered back and he fell  
504 down on the ground. And as I was monitoring h- the suspect, and um, Deputy  
505 Wang, 'cause I wanted to make sure he wouldn't keeping his finger in the  
506 trigger 'cause the Taser will continuously keep going. And I'm - I'm a Taser  
507 instructor so I look for these things, okay? Um, I saw that he had a probe in  
508 the forearm and a probe in the body - right around the chest area. Uh, so the  
509 suspect fell flat on his back and when he did I could tell the suspect was under  
510 the influence 'cause he was staring straight up at the sky and he was talking to  
511 God. And I've been tased as an instructor and you're not talking. The only  
512 thing you're doing is either screaming or you're gonna be quiet. There's  
513 nothing you can do. This guy was talking through the Taser to God. At that  
514 point I figured he had to be under the influence of some PCP or some bath  
515 salts. As the five second deployment stopped. I went to grab the suspect's arm  
516 to try to roll him over. He - and he literally pulled away from me like I wasn't  
517 even there. In fact he pulled me off balance so I let go. Because I knew that if  
518 I fell on the wires I was gonna get the next deployment.

519  
520 Q: Okay.

521  
522 A: Okay? The suspect then got up, um, I mean he just leapt up. And as soon as he  
523 got up Deputy Wang, um, deployed a secondary five, uh, second burst. Uh,  
524 the suspect went back down on the ground. Uh, we tried to grab him and roll  
525 him over, um, but, he - he was just pulling away from us. He was way too  
526 strong. Um, at that point I saw one of the wires was broke. So I knew that the  
527 Taser - his Taser was going to be ineffective at that point.

528  
529 Q: Okay.

530  
531 A: Um, 'cause even if he had turn- cycled it, I knew it was not going to have any  
532 effect because he had to complete the cycle by doing a drive stun with the  
533 probe in and I knew that that was not gonna happen. So, the suspect got up  
534 and he started running diagonal across the intersection into the northbound  
535 traffic lanes. Deputy Wang and Deputy Watt, Deputy Lorenzatti and Deputy  
536 DeMartini was al- was there at that point 'cause I saw 'em out of the corner of  
537 my eye. We followed o- we followed over, uh, to try and get the suspect in  
538 custody. He was yelling something incoherent. I don't know what he was  
539 yelling. He was yelling something about God and he was - I think he was  
540 talking to - he - he acted like he was actually talking to God and, like, we



541 weren't there. Then he yelled out something else and I - incoherent - I - I  
542 didn't remember what that was. Uh, but Deputy Wang then deployed his ASP  
543 and, um, uh, I don't know if Deputy Wang made contact with him. Because at  
544 one point I saw - I knew Deputy Wang had been struck by the suspect because  
545 I actually saw his ASP and his Taser literally fly through the air. Um, then we  
546 managed to surround the suspect. And the suspect then, um, lowered his  
547 center of gravity - he basically ah, line - he was gonna - he was trying to  
548 linebacker tackle Josh. And basically, lowered his center of gravity and he  
549 went to pull, you know, grab his legs and pull him off balance and take Josh to  
550 his back. At that point I saw the suspect it was actu- had - had his gun. And I  
551 was worried at that point that we were gonna be in a OIS. Because we had  
552 literally escalated through our entire use of force. We escalate - we did verbal,  
553 we did, uh, Taser, we did baton, um, and the last one OC was coming next.  
554 Um, but somehow the suspect went to the ground. I - I don't know how he  
555 went, maybe he tripped - I don't - I'm just speculating that. But once he was  
556 on the ground I told everyone to get on top of him. Because I wanted to -  
557 maybe think - maybe we could just control him and we could get more units  
558 there. 'Cause I think I called for code three cover at that point. S- I called for  
559 additional units and then everyone started coming. San Bruno started coming,  
560 our Transit Bureau started coming. So, once we got on top of him, um, Deputy  
561 DeMartini was down by the feet, Deputy Lorenzatti was on the legs. Um, I  
562 was trying to get his right arm where the Taser probe was. Uh, and the reason  
563 I remember that is 'cause he was bleeding pretty profusely and my hands were  
564 slipping off of him because of all the blood. But I knew I couldn't let go of  
565 that arm. I had to try to get it behind his back. Um, and then I was told it was  
566 Deputy Wang who deployed the OC. But when he went to - I think what he  
567 did was he positioned it to try to get under the suspect's face. But what  
568 happened is, um, is when he deployed it it completely missed the suspect.  
569 Deputy Watt took a direct hit to the face. Deputy Lorenzatti took a direct hit  
570 and I received the splash back of all that. Um, Deputy Watt was completely  
571 incapacitated. Um, I knew there was no way he could continue, um, and  
572 'cause he couldn't breathe, so, he had to back off. Um, Deputy Lorenzatti, um,  
573 she - she told me the same thing. She was starting to yell - I think she was  
574 yelling, "Sarge, I can't breathe - I can't see Sarge." Um, and I, um, and I told  
575 her, you know, "Hey, you just hang in there, stay in this fight, um, we- we  
576 need to get this guy into custody." Um, and I think I told her I was - I was hit  
577 too, 'cause I knew I was.

578  
579 Q: Okay.

580  
581 A: So, um, I managed to pull his arm out from under him and get it behind his  
582 back. I - I yelled out, "I need handcuffs - I need handcuffs." Somebody put a  
583 pair of handcuff- one handcuff on him and I said I need a second pair because  
584 the guy was - there was no way we were getting his hands behind his back  
585 with one pair. Um, somebody - I don't know who - uh, locked up the second

586 pair of handcuffs. Um, and I think Deputy Wang was successful in getting his,  
587 uh, other arm behind his back and he was able to get handcuffed. Um, once  
588 we got handcuffed, um, I immediately became - became concerned for  
589 positional asphyxiation for the suspect 'cause I knew we were on top of him.  
590 So, I w- told everyone to get off of him and sit him up. I wanted to sit him up,  
591 like, immediately. So I think within maybe ten seconds I had him sitting up.  
592 Um, and as soon as he sat up, um, I checked his pulse - he had a pulse. He was  
593 - he was, uh, not responsive. Uh, but then all of a sudden he woke up and he  
594 was looking around. Um, and then from there, uh, I had the fire medics come  
595 in 'cause they were staging. Uh, I knew I had three deputies that were hurt at  
596 the time. Uh, so I just started, you know, following our protocol. I wanted to  
597 set up a crime scene. So, we started setting up crime scene tape. Um, I called  
598 for our, uh, ca- captain Alpha 7, uh, 'cause I needed - I needed a supervisor at  
599 the scene. Uh, I think I started directing everyone to start at that point - start  
600 getting witness statements. Um, I saw that Deputy Josh Wang at that point  
601 was bleeding pretty profusely from the face. So, I wanted to get him, uh,  
602 medical attention right way. 'Cause I - I honestly didn't know how or what  
603 injuries he sustained. Um, Deputy Watt, um, a city worker had stopped and  
604 got out of the car started pouring water on Deputy Watt's eyes, so I knew he'd  
605 be okay. Um, then we - I was trying to attend to Lorenzatti but at the same  
606 time I'm trying to watch the suspect. Um, and Deputy DeMartini was he- he  
607 was okay, he wasn't hurt. Um, so at that point I think it was more just starting  
608 to get the crime scene set up. Get that guy medical attention right away. Um,  
609 and so the paramedics were attending to all of our deputies and then he at  
610 some - he at some point, um, just - I - I looked over and I saw he was alert, he  
611 was looking around. And then the paramedics were attending to him and all of  
612 a sudden, uh, he just - he coded. And the paramedic - he, uh, was yelling to  
613 the captain, "Hey, I need the, uh, I need to get the, uh, the heart monitor on  
614 him." But he didn't hear him 'cause he was attending to one of my guys. And,  
615 so, I went over and I told him, I say, "Hey, man, this guy needs that right now.  
616 He - that guy's dying." And so, they all started working on him. And, uh, so  
617 as soon I knew that happened I just started following the - our protocol to try  
618 and get everything going.

619  
620 Q: Okay. You talked about a couple other, uh, call signs, like Joshua Wang's and,  
621 uh, Captain Kunkel's. What was your call sign for that?

622  
623 A: Uh, Sam 60.

624  
625 Q: Okay. Do you remember the other officer's call signs?

626  
627 A: Yes, Deputy Lorenzatti is, uh, Boy 61 and Deputy DeMartini is Boy 40 - he  
628 was assigned to the Eichler Highlands that day.

629  
630 Q: Okay. And Watt?

631  
632 A: Uh, he's Boy 60.  
633  
634 Q: Okay. Um, you talked about, um, leaving the station - hearing the call -  
635 leaving the station. You said, "We all were leaving." Who is, "We all?"  
636  
637 A: I think Deputy Lorenzatti was in front of me. Um, she was the only one I think  
638 was in front of me. I don't remember how long behind me, uh, Deputy  
639 DeMartini was. So...  
640  
641 Q: But you were - three were at the station together prior to that?  
642  
643 A: Yes.  
644  
645 Q: Okay. And you knew that all three of you were leaving the station at the same  
646 time?  
647  
648 A: Yeah, of course, anyone calls code 3 cover...  
649  
650 Q: Right.  
651  
652 A: ...everybody's coming.  
653  
654 Q: Okay. When, um, Officer Watt was - not s- Officer Wang - when Officer  
655 Wang was putting out initial information - did he ever provide a de-  
656 scription of the - the subject?  
657  
658 A: Not that I recall. I just heard he said I have a subject that is running through  
659 traffic.  
660  
661 Q: Okay.  
662  
663 A: I don't recall him putting out an actual description.  
664  
665 Q: So when you got there and saw somebody...  
666  
667 A: Yeah.  
668  
669 Q: ...how did you know that that was the person?  
670  
671 A: Oh, 'cause we all, uh, 'cause I saw Deputy Wang's ...pull his vehicle up. H-  
672 that was the only guy on the sidewalk. And i- uh, as we were pulling up he  
673 immediately threw his hands up in the air.  
674  
675 Q: Okay.

676  
677 A: There was no one else around so I figured that was the guy.  
678  
679 Q: Okay. And - you can correct me if I'm wrong on this - but I believe what you  
680 said was that they had already kinda engaged with him...  
681  
682 A: Yes.  
683  
684 Q: ...as you're approaching...  
685  
686 A: Yes.  
687  
688 Q: ...so, what was your thought process coming into there? Did you feel like you  
689 needed to help them get him under control right away or were you trying to  
690 assess the scene - what was your kinda mindset right then?  
691  
692 A: Well, it's - it's hard as a supervisor - as a sergeant - because you wanna let  
693 them do their job - you wanna help them - but then if you try to take over  
694 they'll back off. So, i- it's a fine line and you have to be a- you have to know  
695 the - know the - know your troops. Know - be able to assess the scene. Assess  
696 what's going on. And you, eh, you have to make that decision of when you  
697 think intervention is, um, necessary. Uh, clearly if I saw - well - I decided they  
698 were doing just fine at the time. Uh, especially, um, they were - they were  
699 giving commands. Uh, I didn't see them rush and, you know, try to, you  
700 know, hit a baton or use ASP - they were - I saw they were going through, uh,  
701 the use of force continuum. They exerc- uh, my opinion - they exercised great  
702 restraint. So, I felt there was no need to intervene. I felt it was good, uh, to let  
703 it go. Even I - at some point I think I was giving commands - when he fell  
704 down. Um, I was trying to end it right then and there by grabbing him and  
705 rolling him over, but that was not gonna happen. This guy had superhuman  
706 strength.  
707  
708 Q: What were some of the commands that you were giving him if you  
709 remember?  
710  
711 A: Stop resisting, I think, uh, roll over on your stomach. Uh, 'cause when people  
712 get tased unless you tase 'em in the back - if you tase 'em in the front they  
713 obviously go right on their backs. They go stiff like a board. So, usually when  
714 you tell 'em roll over they wanna roll over really fast. Because they don't  
715 want it again. And that's when we can, uh, handcuff 'em.  
716  
717 Q: Okay.  
718  
719 A: Uh, but this guy was not - that was not happening.  
720

- 721 Q: You talked a little bit about him talking to God or whatever.  
722
- 723 A: Yeah.  
724
- 725 Q: Do you remember hearing him say anything specific kinda leading up to that  
726 before he gets tased?  
727
- 728 A: No, I didn't - I did not hear that - anything that he said, uh, because I was  
729 probably a good 20 feet away, uh, from Josh when he tased him. But when h-  
730 uh, the suspect assaulted Josh, uh, he started moving towards me. When Josh  
731 tased him he fell down and I was pretty much clearing the distance right away.  
732 So, as he was laying there the suspect was on his back with his arms like this.  
733 And he had this - this 1,000 yard stare on his face and he was literally talking  
734 straight up, like, we were not even there. He was talking, uh...  
735
- 736 Q: Do you recall what he was sayin' when he was talking?  
737
- 738 A: No, he just some- he was saying something God - something God. And he was  
739 just going on.  
740
- 741 Q: Okay. Um, at any point do you recall anything that he said specifically or just  
742 - was it hard to recall or is it - was it - difficult to understand him?  
743
- 744 A: No, it wasn't difficult it was - at one point he yelled out, "What did I do?"  
745
- 746 Q: Okay.  
747
- 748 A: Um, but I think that was across when he had - were - already come across and  
749 reengaging him. But after he yelled, "What did I do?" Um, then he turned  
750 around he - he started assaulting Josh again and he started assaulting every  
751 one of us. So it was like he had a second of clarity and then he just kept  
752 attacking.  
753
- 754 Q: Okay.  
755
- 756 A: And the whole time everyone was yelling, "Get down on the ground. Stop  
757 resisting. Stop fighting." I mean we were trying to deescalate it but it was not  
758 gonna happen.  
759
- 760 Q: You've talked about his strength.  
761
- 762 A: Yes.  
763
- 764 Q: Where you perceive the strength. Um, is there any other things that you  
765 noticed about him about him than kinda the 1,000 yard stare and the strength -



766 were there other indicators to you that he was possibly under the influence or  
767 anything that you noticed about...  
768

769 A: Well he was a very big guy. Um, I would say he's probably a little over 6 foot.  
770 Probably somewhere in the neighborhood of 300 - 320 pounds. Um, and, you  
771 know, I know Deputy Josh Wang. He's about as tall as I am - maybe 5'9" -  
772 5'10". He's probably about 160 pounds. Uh, Deputy Lorenzatti, a small  
773 female. Um, so, I mean this guy has significantly outweighed us.  
774

775 Q: Yeah.  
776

777 A: And then if you add the fact that whatever drugs he had onboard. Um, I'm  
778 guessing - I believed he probably had PCP or bath salts - 'cause I've seen  
779 people on both. Um, you add that in there and there's just no stopping a man  
780 that size.  
781

782 Q: Yeah. Um, is that based kinda on his reactions to the Taser and things like that  
783 or were there other kinda objective symptoms that you noted?  
784

785 A: Well, like, n- no, I didn't have time to observe his pupils...  
786

787 Q: Right.  
788

789 A: ...if that's what you're getting at. I never take his pulse or anything like that.  
790 The symptoms that led me to believe that he was under the influence, of, uh,  
791 something like PCP or bath salts is when he was laying on his back and he  
792 was getting tased for the five seconds - he was able to talk. You can't do that,  
793 okay? It - it does not happen. He was able to talk to God when he was doing  
794 that. And that's when I knew, um, he's under the influence of either PCP or  
795 bath salts or something like that.  
796

797 Q: Okay. Do you, uh, wear any corrective lenses or any...  
798

799 A: I do.  
800

801 Q: Okay.  
802

803 A: I wear reading glasses.  
804

805 Q: Okay.  
806

807 A: 1. - 1.25.  
808

809 Q: No other vision problems other than for reading purposes? No other...  
810

811 A: No, it's just for reading.  
812  
813 Q: Okay. No contact lenses...  
814  
815 A: No.  
816  
817 Q: ...or anything like that? And you had a clear view of everything that was going  
818 on?  
819  
820 A: Correct.  
821  
822 Q: Okay. And lighting conditions were - were...  
823  
824 A: It was daylight.  
825  
826 Q: Right. Uh...  
827  
828 A: Approximately 1:00 in the afternoon or something, like, right around that  
829 time.  
830  
831 Q: I think that you talked about the only - you mentioned the light pole kinda  
832 blocking some visibility initially. Was there anything else that was kinda  
833 obstructing your view at any points in time?  
834  
835 A: Not that I recall - no. Not when they made initial contact. After that  
836 everything was clear.  
837  
838 Q: Okay.  
839  
840 A: 'Cause he was coming, like, towards me.  
841  
842 Q: And when you were kinda essentially piled up on him on the ground...  
843  
844 A: Oh, yeah.  
845  
846 Q: ...it sounds like things were harder to observe from what you describe.  
847  
848 A: Well yeah, because I was OC'ed - I was pepper sprayed.  
849  
850 Q: Oh, hm.  
851  
852 A: Yeah.  
853  
854 Q: Um, what kind of car were you driving?  
855

- 856 A: I was driving a Ford Explorer SUV - fully outfitted - full sheriff markings -  
857 full light bar - everything.  
858
- 859 Q: With video. We've talked about - about the MAV video.  
860
- 861 A: Yes I have MAV video in my vehicle and my MAV video was on and I also  
862 had my microphone on which I think captured all the audio.  
863
- 864 Q: Okay. Is that something that activated automatically or something that you  
865 have to activate?  
866
- 867 A: So I have to activate it. So in the morning, um, what we do is we get in the car  
868 - we take out the microphone and put it on a - we turn it over, turn it on - put it  
869 on our vests. And anytime you turn the, uh, position switch to number two -  
870 the record goes on in there. There's an audio beep and you see it's recording  
871 and then our a- your, um, audio turns on.  
872
- 873 Q: By position two you're talking about on the lighting equipment?  
874
- 875 A: Correct. On the lighting equipment. To take - to the take - front take down red.  
876
- 877 Q: Was all the equipment in the vehicle functioning properly?  
878
- 879 A: Yes.  
880
- 881 Q: Yep. And all of your equipment on you - was it functioning properly?  
882
- 883 A: Yes.  
884
- 885 Q: Um, at any point did you, um, transition to any of your weapons that were  
886 available to you? Your less-lethal weapons or anything?  
887
- 888 A: No I did not. Because I already knew that the Taser didn't work. So, me  
889 deploying my Taser was gonna have the same effect.  
890
- 891 Q: Okay.  
892
- 893 A: I already knew, uh, well we were already pepper sprayed. So, uh, that wasn't  
894 gonna work, um, 'cause we were - we were all pepper sprayed at that point.  
895 The baton was clearly not gonna work on a man this size. Um, so, I knew that  
896 the next escalation of force was, um, to use deadly force. And when he went  
897 to the ground I was trying to avoid that by telling everyone to get on top of  
898 him. So I was trying to avoid a deadly force situation.  
899
- 900 Q: Yeah. So, there was never any time where you would have had your Taser out

901 or your ASP out or...

902

903 A: I did take my Taser out...

904

905 Q: Okay.

906

907 A: ...at one point when I initially got out of the car. But when I saw the - he - that  
908 his Taser was not working, then as an instructor I tell people, hm, then you  
909 don't tase him. If - if one's not working yours not gonna work any better. So, I  
910 - I put it away.

911

912 Q: Okay. Um, when he was on the ground were there any holds that were used -  
913 something like the carotid or anything like that to your knowledge?

914

915 A: No, we did not use the carotid.

916

917 Q: Okay. And you certainly did not?

918

919 A: No, I did not.

920

921 Q: No? Did you clear view of what everybody else was doing?

922

923 A: Yes.

924

925 Q: Okay. And nobody did?

926

927 A: No, nobody did.

928

929 Q: Okay.

930

931 A: He was on, uh, his stomach, um, over on his right side stomach and he was,  
932 you know, on his right side roll into his stomach. And we were try- I was  
933 trying to get him there 'cause I was trying to pull his right arm behind him.

934

935 Q: Okay. Other than obviously wearing full uniform anything like - do you recall  
936 ever - either yourself or hearing the other officers identifying themselves as  
937 police officers to him or anything like that?

938

939 A: No, I - I do not, no.

940

941 Q: No?

942

943 A: Well it was pretty obvious we're deputy sheriffs.

944

945 Q: Yeah. Everybody there was in full uniform?

946  
947 A: Full uniform...  
948  
949 Q: Okay.  
950  
951 A: ...fully marked, uh, Sheriff's Office patrol vehicles.  
952  
953 Q: Okay. Um, at some point in time and one of the CSOs is there?  
954  
955 A: Correct.  
956  
957 Q: Involved as well. Do you recall where he was and what he was doing?  
958  
959 A: Uh, I think he gave me a pair of handcuffs. I think he was the one that leaned  
960 in and gave me a pair of handcuffs. Um, and as the reason I say I think is  
961 because I was fighting to keep my eyes open from the pepper spray. So, what  
962 I was seeing was kinda blurred. Um, but I knew I had to try to keep my eyes  
963 open 'cause everyone else was pretty much out of the fight at this point.  
964  
965 Q: Okay.  
966  
967 A: Um, and I was trying to encourage them to stay in it.  
968  
969 Q: But there's - was there something that you saw that made you think that it was  
970 him specifically or...  
971  
972 A: Yeah, 'cause I saw a flash of light blue. And they wear, like, baby powder  
973 blue shirts.  
974  
975 Q: Okay. Uh, what's his name by the way?  
976  
977 A: Joey Gonzales.  
978  
979 Q: Joey Gonzales, okay. Um, as far as you know that would have been his only  
980 involvement? Is...  
981  
982 A: Yeah, I don't think he did anything else.  
983  
984 Q: Okay.  
985  
986 A: He - he just came over 'cause I k- I was yelling out, "I need a pair of  
987 handcuffs - I need a pair of handcuffs." So, I think he just ran over and gave  
988 me a pair of handcuffs. 'Cause everyone else was already occupied.  
989  
990 Q: Um, as this was evolving did you see that Gonzales was already as well or his

991 truck was out there or...

992

993 A: I didn't know he was there until he handed me handcuffs.

994

995 Q: Okay.

996

997 A: 'Cause I was too focused on the deputies and the suspect.

998

999 Q: And the public works people that were out there is that kinda a similar? Did

1000 you see that they were there prior or not until after or...

1001

1002 A: Not till after, uh, one of the public works guys - he - when we started the

1003 struggle in the intersection he happened just stop - he was in traffic. He just

1004 happened to be there.

1005

1006 Q: Okay.

1007

1008 A: And, uh, he was the one that actually started rendering aid to Deputy Watt by

1009 giving water. 'Cause Deputy Watt was yelling, "I need water - I need water to

1010 flush my eyes." And he actually, uh, was giving him water. And he was

1011 marked - in a city marked vehicle and they were wearing green fluorescent

1012 shirts so that's why I knew it was a Millbrae city worker.

1013

1014 Q: Okay. And obviously working in Millbrae you interact with some of these

1015 people and see...

1016

1017 A: Yes, we have a good relationship with them. So that's how we know 'em.

1018

1019 Q: And how long have you been assigned to Millbrae again?

1020

1021 A: So, I just rotated there in March. But, prior to that I was a patrol deputy there

1022 for - since the day we t- well merged with the city. So, I think I was there for

1023 three years as a patrol deputy. I went back to the jail, got promoted to sergeant

1024 about a year and a half later - did about a year and a half in the jail and then I

1025 rotated back there in March of this year.

1026

1027 Q: Okay. So, you've been there since March of this year?

1028

1029 A: Yeah.

1030

1031 Q: Along with working overtime shifts various other locations?

1032

1033 A: Yes.

1034

1035 Q: Okay. Um, did you recognize this guy at all? Is he somebody you had ever



1036 seen?  
1037  
1038 A: Never seen him before a day in my life.  
1039  
1040 Q: Okay.  
1041  
1042 A: I don't even know his name. Did - did you guys identify him?  
1043  
1044 Q: They did. I don't actually recall his name. It's kind of an odd pronunciation -  
1045 I'm not even sure I could pronounce it.  
1046  
1047 A: Okay.  
1048  
1049 Q: But, um, did you receive any injuries from what happened?  
1050  
1051 A: (Unintelligible) just t- uh, the O- pepper spray and then waking up this  
1052 morning with, uh, just a little sore.  
1053  
1054 Q: Yeah.  
1055  
1056 A: Yeah, but no physical injuries that require me to go to the hospital.  
1057  
1058 Q: What - what's sore? I mean what areas?  
1059  
1060 A: Uh, my back, my legs and, you know, just from the exertion.  
1061  
1062 Q: Okay. The scratch on the back of your hand is that anything from last...  
1063  
1064 A: Yeah, he did that.  
1065  
1066 Q: And, okay.  
1067  
1068 A: Yeah, he - he did that yesterday, just a scratch.  
1069  
1070 Q: You don't know - do you know exactly how those occurred or just, they were  
1071 there after, um...  
1072  
1073 A: Yeah, I have no idea.  
1074  
1075 Q: All right. Do you, uh, take any prescribed medications or anything?  
1076  
1077 A: No.  
1078  
1079 Q: No? Okay. No - you would have no medications in your system during...  
1080

1081 A: No.

1082

1083 Q: Okay. Um, so obviously you woulda not felt any effects of medication?

1084

1085 A: Correct.

1086

1087 Q: Skip some of this stuff - let's talk about your training. You mentioned, um...

1088

1089 A: Sure.

1090

1091 Q: ...being an instructor. Talk a little bit about as your experience as a Taser

1092 instructor and how you became certified and all that.

1093

1094 A: So, I, uh, I'm a member of our range staff. I've been on our range staff for

1095 approximately ten years. Um, so I'm one of the lead firearm instructors. Um,

1096 certified rifle and handgun instructor and while you're on the range staff they

1097 give other ancillary duties. So I was sent to tasering school - so I'm a Taser

1098 instructor. Um, I'm also an OC instructor, um, which we just trans- switched

1099 over to a new OC. Uh, so I teach classes - I certify all the new people who

1100 come in. Uh, if they don't have the Taser training we put on an eight hours

1101 class and then we teach 'em how to use the Taser and talk about liabilities -

1102 policy and procedure - things like that.

1103

1104 Q: Yep. As the tasering school - what does that consist of?

1105

1106 A: So we have to go to a two day, uh, Taser school and the one I went to was

1107 hosted in Alameda County. Um, they talk about the, uh, the liabilities, what

1108 the Taser does, who makes it, you know, give you all the background, And the

1109 time I went through, um, you were required to, uh, take a hit, uh, to be

1110 certified. And if you didn't wanna take a hit they wouldn't certify you.

1111

1112 Q: The - and was that the - a brief hit or was it a full five seconds?

1113

1114 A: Full five second ride.

1115

1116 Q: Okay, so...

1117

1118 A: And I opted to take the probes in the back. So there's two ways they do it -

1119 they'll hook on alligator clips to you and then they'll tase you or you can

1120 actually get shot with a Taser where the probes deploy. And I chose to get

1121 shot with it 'cause I wanna be able to experience that.

1122

1123 Q: Okay. And...

1124

1125 A: And I do not recommend it.

1126  
1127 Q: I actually had to be tased when we carried them in my prior agency.  
1128  
1129 A: So you know.  
1130  
1131 Q: So, yes, um, uh, it was not a pleasant experience.  
1132  
1133 A: No.  
1134  
1135 Q: Um, is that the only time you've experienced being tased?  
1136  
1137 A: Yeah, 'cause I refused to do it. Even when I got recertified and they asked for  
1138 volunteers - I said, "No way man."  
1139  
1140 Q: Um in addition to the things you've mentioned - you've mentioned, um, being  
1141 the pepper spray, being the Taser instructor...  
1142  
1143 A: Mm-hm. Sure.  
1144  
1145 Q: Um, any defensive tactics training or, um, training with the ASP - anything  
1146 like that?  
1147  
1148 A: No, I'm not. Uh, our Def- DT instructors do the control holds and the ASP  
1149 training.  
1150  
1151 Q: Yep. Which you've obviously attended courses where you are trained?  
1152  
1153 A: Correct. Yes.  
1154  
1155 Q: Okay. And how frequently do you do that?  
1156  
1157 A: Uh, I think we have to do DT once a year.  
1158  
1159 Q: Okay. And have you done that pretty recently?  
1160  
1161 A: I believe so. I can't recall when the last class was.  
1162  
1163 Q: Okay. Ultimately we will look at training records and things like that, but...  
1164  
1165 A: Sure.  
1166  
1167 Q: ...just asking if you remembered. Um, how about first aid training? Do you  
1168 have any additional first aid training or just kinda the standard...  
1169  
1170 A: Uh, I have the standardized first aid training that we receive every year. But I

1171 also - I think it was last year - I went to an eight hour tactical medi- m-  
1172 medical school put on by the Department of Homeland Security which talked  
1173 about how to - the use of tourniquets and emergency medicine in the field.  
1174  
1175 Q: Okay. Would that have also dealt with some of the things that you would have  
1176 been seeing in this incident?  
1177  
1178 A: Um, no, the more of the CPR portion was this. Because my primary concern  
1179 was his breathing.  
1180  
1181 Q: Okay.  
1182  
1183 A: Um...  
1184  
1185 Q: Um, how about any training in tactical communications or CIT training or  
1186 anything like that?  
1187  
1188 A: Yes I'm CIT certified. Um, for some reason I went to two (unintelligible)  
1189 school - the school twice. I don't know why but I felt I needed it. So, uh, but  
1190 yes I am certified in CIT. Um, I'm all fr- familiar with de-escalation. I was  
1191 trying to de-escalate the situation. Uh, I was also trying to prevent the - the  
1192 situation from escalating to deadly force.  
1193  
1194 Q: Okay. And have you had success in de-escalating situations previously with  
1195 your CIT training?  
1196  
1197 A: Yes, absolutely.  
1198  
1199 Q: Um, all right. Is there anything else that you can think of that maybe you  
1200 haven't told me along the way that you think would be important for us to  
1201 know right now?  
1202  
1203 A: No, I don't think so. I think I told you everything to the best of my memory.  
1204  
1205 Q: Okay. We're gonna take a break for a couple minutes. I'm gonna confer with  
1206 my supervisors and certain things outside and let you confer with your  
1207 attorney for a few minutes. I'm gonna leave this running so if we wanna come  
1208 out and...  
1209  
1210 A1: Yeah - yeah we'll just go out (unintelligible).  
1211  
1212 A: Can I get another water too?  
1213  
1214 Q: Yeah.  
1215

1216 A: Thank you.  
1217  
1218 Q: We'll track one down for you.  
1219  
1220 A1: And, um, we can go out into the hallway...  
1221  
1222 A: All right.  
1223  
1224 A1: ...and go into that, uh, witness room.  
1225  
1226 A: Thanks.  
1227  
1228 ((Crosstalk))  
1229  
1230 Q: All right.  
1231  
1232 A: Don't you have air conditioning in this room?  
1233  
1234 A1: It's a good 5 degrees more...  
1235  
1236 Q: You know what, they do turn it off after hours at some point.  
1237  
1238 A: Apparently they do.  
1239  
1240 Q: Gotta save bill around here.  
1241  
1242 A1: (Unintelligible) right?  
1243  
1244 Q: Yeah. Um, so a couple - just a little real quick kinda question. Um, just to  
1245 clarify a couple little things that were talked about along the way.  
1246  
1247 A: Sure.  
1248  
1249 Q: Um, we talked a little bit about the initial contact or at least what you saw...  
1250  
1251 A: Mm-hm.  
1252  
1253 Q: ...of the initial contact and what you heard on the radio responding. Um, why  
1254 were they contacting him?  
1255  
1256 A: Uh, so after this was over and Deputy Wang was in the ambulance, um, I  
1257 asked him, I said, "Hey, can you just kinda give me a quick brief of what  
1258 happened?" And he said, "Well, he darted across traffic, so I was gonna  
1259 contact him for jaywalking and then when I went to contact him he started  
1260 literally running in and out of traffic."

1261  
1262 Q: Okay. And did you hear some of that information being broadcast, a little  
1263 before this? That you responded...  
1264  
1265 A: Yes, he was putting it out on the radio - saying that, "Th- he's running into  
1266 traffic. He just ran from me, now he's running in and out of traffic." I heard  
1267 that on the air.  
1268  
1269 Q: Okay. And, in your mind why would you wanna contact somebody under  
1270 those circumstances?  
1271  
1272 A: Oh, it was obvious to me it he sounded like he was under the influence and he  
1273 was a danger to himself and other people and the public.  
1274  
1275 Q: Okay. Because he was going into the roadway?  
1276  
1277 A: Right, 'cause nobody - no normal person runs in and out of traffic. Especially  
1278 in Millbrae.  
1279  
1280 Q: And this was on El Camino Real.  
1281  
1282 A: Yes.  
1283  
1284 Q: Mmm, a very busy street?  
1285  
1286 A: It was - that area is very behind traffic. I mean the El Camino is very busy, but  
1287 Millbrae constantly has auto/peds. So, that area is very - very busy.  
1288  
1289 Q: Okay. Um, in their attempts to, um, contact him, mmm, initially, um, what do  
1290 you think they were trying to accomplish in contacting him and detaining?  
1291  
1292 A: Well probably what I would of done if I was in their position - let's detain him  
1293 - let's see if he's under the influence - let's get him medical attention. Uh,  
1294 let's see if he's a danger to others - we'll place him on a 5150 hold. 'Cause if  
1295 he's under the influence, clearly he can't be, uh, let go. We have to get him  
1296 medical attention.  
1297  
1298 Q: Okay. Um, now jumping forward a little bit to kinda the second area when  
1299 he's over by...  
1300  
1301 A: Sure.  
1302  
1303 Q: ...the CSO truck and kinda the - kinda the end point if you will. Um, you  
1304 mentioned that he was grabbing, um, Officer Wang or Deputy Wang's  
1305 firearm. How was he grabbing it?



1306  
1307 A: So, he - when he went to linebacker tackle him and what I mean by that is  
1308 Deputy Wang was standing straight up this guy bent down and he tried to sh-  
1309 put his shoulder into his waist. So he went for that, um, most people try to  
1310 grab the legs 'cause they wanna sweep you. He went specifically and reached  
1311 around and grabbed his gun.  
1312  
1313 Q: And so how was he holding? Was he holding, like, kinda (unintelligible)...  
1314  
1315 A: Like this.  
1316  
1317 Q: ...like the holster or the (unintelligible)?  
1318  
1319 A: He had his hand on the gun and the holster.  
1320  
1321 Q: Okay.  
1322  
1323 A: Kinda like the handle and, you know...  
1324  
1325 Q: Okay.  
1326  
1327 A: Um, and well I can't say for sure - I can't say if I saw him try to pull it - I  
1328 can't say that.  
1329  
1330 Q: Just - just that he had a hold of it?  
1331  
1332 A: Yes.  
1333  
1334 Q: Okay. Um, when - did - you talk about the blood on his arm.  
1335  
1336 A: Yes.  
1337  
1338 Q: And being very slippery and you talked about it being from the probe. Was  
1339 the probe still in his arm at that point in time?  
1340  
1341 A: Yes it was.  
1342  
1343 Q: So you saw the probe in his arm?  
1344  
1345 A: Correct. 'Cause I think the probe - I'm - I'm speculating, but I think that the  
1346 probe is what cut me. 'Cause me - I kept sliding 'cause all the blood. I kept - I  
1347 - I could not let go of that arm. So...  
1348  
1349 Q: Okay. Um, and then kinda the last area is run me through some of kinda your  
1350 emotions through this whole thing and how you were feeling and what

1351 concerns you had ...

1352

1353 A: The only concerns I had were the safety for my deputies. I wanted to make  
1354 sure they were okay.

1355

1356 Q: And what did you fear could happen?

1357

1358 A: I feared we were gonna be in a OIS. Um, we had - we did everything possible  
1359 to - to restrain this guy. We used every escalation of force possible or de-  
1360 escalation of force possible. I knew Deputy Watt was completely  
1361 incapacitated from pepper spray. I knew Deputy Loren - Lorenzatti was  
1362 incapacitated 'cause she kept telling me she couldn't see. Um, I was, um,  
1363 probably about 30% incapacitated. I could still o- force open one of my eyes.  
1364 Um, so I knew that if this guy got off of the ground I was gonna have to shoot  
1365 him. So we were doing everything we could to try to avoid a deadly force  
1366 situation.

1367

1368 Q: Mm-kay. Do you have anything else that you would like to ask?

1369

1370 A1: Yeah, just a few follow up questions. Um, we were talking about how you  
1371 didn't have time to notice really signs or symptoms of being the - under the  
1372 influence. But certain things that the subject was doing at the scene led you to  
1373 believe he could be, um, under the influence or 11-5 right?

1374

1375 A: Right.

1376

1377 A1: Um, so, uh, it - did the fact that he was able to get up almost immediately after  
1378 being tased that first time indicate anything to you about that?

1379

1380 A: Yeah, that's what told me he was under the influence. Because as you know  
1381 from being tased and as I know from being tased - your muscles lock up. And  
1382 usually after you lock up and the five seconds ride over you kinda just - you  
1383 know, you're like, "Oh, my gosh." Well when that five second ride was over  
1384 with him he just sprung right back up. And knew right away I go, "He's - he's  
1385 got drugs - he's got drugs on board." Um, and the second time he hit - he went  
1386 down - same thing - he sprung back up. That's why we ended up on the  
1387 opposite of the El Camino.

1388

1389 A1: And so in your training and experience I'm guessing you're familiar with  
1390 people who have, uh, who you have observed under the influence of a  
1391 numerous amount of drugs, right?

1392

1393 A: Yes.

1394

1395 A1: And, um, specifically stimulants...

1396  
1397 A: Stimulants, opioids, uh, whatever you...  
1398  
1399 A1: PCP, bath salts...  
1400  
1401 A: Yes.  
1402  
1403 A1: ...any of that kinda stuff? Um, and so in your experience, uh, someone under  
1404 the influence do they register pain necessarily like someone who is not?  
1405  
1406 A: No, they typically, um, the - the biggest indicator is that he - to me what I  
1407 believe was either PCP or bath salts is his lack of feeling any pain.  
1408  
1409 A1: Mm-hm.  
1410  
1411 A: And his literally super human strength.  
1412  
1413 A1: Okay.  
1414  
1415 Q: Um, and just touching off of that real quickly. Like, she kinda went down this  
1416 area, but, have you had any formal training in 11-5 or DRE or anything like  
1417 that?  
1418  
1419 A: Yes, I've been to, uh, several 11-5 schools. Um, I don't know exactly when -  
1420 what years. Um, plus you - when you worked as an intake deputy you literally  
1421 see 1,000's of people coming through under every drug, alcohol, whatever  
1422 you can imagine - you see it.  
1423  
1424 Q: And you've had experience arresting people and evaluating people for being  
1425 under the influence?  
1426  
1427 A: Yes.  
1428  
1429 Q: Okay. Um, we've talked about kind of the - the under influence aspect of the  
1430 Taser and the effects on it. Does mental health in your experience also, uh,  
1431 play a factor in the effectiveness of the Taser?  
1432  
1433 A: Yes, um, i- it depends those on individual's - when you're, you know, when in  
1434 CIT training they kinda teach you to look for certain things. You know, and,  
1435 but it just depends on the individual. Um, the fact that he was not talking, he  
1436 was unresponsive but willing to fight. Uh, the strength, all that stuff led me to  
1437 believe he's probably just under the influence of some type of PCP or drug.  
1438 'Cause normally people with mental health - like, if we rewind and go back to  
1439 the earlier in the day when I told you about the black female we contacted...  
1440

1441 Q: yeah.  
1442  
1443 A: ...she clearly had obviously mental health issues. But, she was coherent and  
1444 she was able to talk and answer questions - she just didn't like it. So, you  
1445 know, and then we fast forward to somebody under the influence, all he  
1446 wanted to do was fight.  
1447  
1448 Q: Okay. All right, I think that (unintelligible).  
1449  
1450 A1: I just have a few final questions for the record.  
1451  
1452 Q: Okay.  
1453  
1454 A1: Um, so, e- we've made reference to the MAV or the Mobile Audio Video  
1455 system, right?  
1456  
1457 A: Yes.  
1458  
1459 A1: And you had that running in patrol car at the time?  
1460  
1461 A: Yes.  
1462  
1463 A1: And you also mentioned that you had a, um, an audio mic attached to your,  
1464 uh, uniform that was recording at the time.  
1465  
1466 A: Yes.  
1467  
1468 A1: But prior to this interview you have not reviewed any sort of audio or video  
1469 you took at the scene, right?  
1470  
1471 A: Correct.  
1472  
1473 A1: And, um, I know that this incident happened yesterday - I'm guessing around  
1474 1:00 pm - 2:00 pm?  
1475  
1476 A: Yeah.  
1477  
1478 A1: Um, have you watched any news media stories or bystander videos...  
1479  
1480 A: No.  
1481  
1482 A1: ...in that time before this interview?  
1483  
1484 A: No ma'am.  
1485

1486 A1: Okay. That's it for me.  
1487  
1488 Q: Okay. Let's get out of here. Get out of the hot room.  
1489  
1490 A1: Yes. It's always like I'm unpacking luggage.  
1491  
1492 A: No.  
1493  
1494 A1: (Unintelligible). Okay.  
1495  
1496 Q: And then we'll, uh, shut this off now - the recorder.  
1497  
1498 A1: Okay.  
1499



**Investigation:**

On October 3, 2018, I was assigned as the primary investigator for the San Mateo County District Attorney's Office investigation into an Officer Involved Critical Incident (OICI) which occurred on that date involving deputies from the San Mateo County Sheriff's Office.

On October 5, 2018, I conducted an interview with Deputy Bryan Watt of the San Mateo County Sheriff's Office. Deputy Watt was one of five (5) deputies who were involved in a use of force incident which included the deployment of a Taser and the use of pepper spray. The subject of the use of force, deceased subject Chinedu Okobi, was later pronounced deceased at Mills-Peninsula Hospital. This incident occurred in the 1400 block of El Camino Real in the City of Millbrae. The interview was conducted at the San Mateo County District Attorney's Office and was documented through both audio and video recording. Also present during the interview was Attorney Gregory Thoming of Mastagni Holstedt, APC. During the interview, I confirmed with Deputy Watt he was providing a voluntary statement to the District Attorney's Office and he had not been ordered to provide a statement by any members of the San Mateo County Sheriff's Office.

Prior to the beginning of the interview, Senior Inspector Massey met with Gregory Thoming who advised us Deputy Watt was requesting to view his Mobile Audio Video (MAV) footage and any civilian video footage prior to providing a voluntary statement in this matter (see Senior Inspector Massey's supplemental report for further details). Thoming reviewed all of the available MAV footage and civilian video footage at the District Attorney's Office prior to meeting with Deputy Watt. Thoming then reviewed Deputy Watt's MAV footage and the available civilian video footage at the District Attorney's Office with Deputy Watt prior to the interview. During the Interview, I confirmed with Deputy Watt that he had only viewed these two videos prior to our interview.

**Interview with Deputy Bryan Watt (paraphrased and not verbatim):**

Deputy Watt stated he has worked for the San Mateo County Sheriff's Office for "a little over twenty-three (23) years". Deputy Watt began his career at the Sheriff's Office as a Correctional Officer and served in that capacity for approximately five (5) years before being promoted to the position of Deputy Sheriff in December of 2000. Deputy Watt stated he had no prior law enforcement or military background prior to being employed by the San Mateo County Sheriff's Office. As a member of the San Mateo County Sheriff's Office, Deputy Watt stated he has been assigned primarily to the San Mateo County Jail and to the Sheriff's Office Patrol Bureau, though he has worked some shifts in the Courts and Transportation Division in the past when they have been short-staffed. Deputy Watt said he is currently assigned to the Millbrae Patrol Bureau.

I asked Deputy Watt to describe the items he typically wears on his duty belt as well as items on his external ballistic vest carrier. Deputy Watt stated he is right handed and carries his duty firearm on his right hip and keeps a secondary, or back-up firearm in a pouch on the right front side of his external vest carrier. Deputy Watt stated he carries both pepper spray and an ASP (collapsible baton) on the left front side of the outer carrier and a pouch with additional magazines for his duty firearm in the center of the

**CONTROLLED DOCUMENT**

Prepared By:  
80205 DRAPER, JAMIE

Date:  
10/12/2018

Approved By:  
80240 WARREN, JOHN

Date:  
12/18/2018





vest. Deputy Watt stated he also carries a tourniquet, a pouch containing latex gloves, one (1) set of handcuffs and his police radio on his vest carrier. Deputy Watt stated his Taser is on the left side of his duty belt, opposite of his firearm, and he carries a second set of handcuffs on his duty belt positioned to the rear of his firearm.

Deputy Watt stated October 3, 2018 was his normal, scheduled work shift and his assignment was day shift, working a twelve (12) hour shift from 6:00 AM to 6:00 PM. Deputy Watt explained he works a rotating schedule and does not have fixed days off. Deputy Watt told me his shift on October 3, 2018 had been his first shift of the work week. Deputy Watt informed me he had worked overtime shifts on both October 1, 2018 and October 2, 2018 and both shifts were during daytime hours. Deputy Watt described his normal assigned beat as including all the unincorporated areas in the northern part of the county from highway 92, north to the San Francisco border. He clarified that his beat excludes the physical city limits within Millbrae, which is a separate beat assignment.

For his shift on October 3, 2018, Deputy Watt stated he was driving his normal assigned vehicle. Deputy Watt described his patrol vehicle as a white Ford Explorer with a blue stripe and Sheriff's Office logos on the vehicle. Deputy Watt stated the vehicle is San Mateo County Sheriff's Office vehicle 37 and is equipped with Mobile Audio Video (MAV); however, the body-worn microphone for the vehicle was missing when he showed up for work that morning. Deputy Watt said he made Sergeant Weidner aware of the fact that the microphone was missing from the vehicle. Deputy Watt said he believed Sergeant Weidner had sent out an Email asking to have the microphone replaced once Deputy Watt informed him it was missing. Deputy Watt stated he was wearing a full wool police uniform with Sheriff's Office patches on the shoulders. Deputy Watt stated he was wearing a ballistic vest carrier outside of his uniform. Deputy Watt said his badge and name tag were affixed to the front of his external vest carrier, which he described as a metal badge and name tag rather than the embroidered type. Deputy Watt was assigned as the sole officer in his patrol vehicle as is standard for patrol within the San Mateo County Sheriff's Office. Deputy Watt identified Sergeant David Weidner as his direct supervisor for his shift on October 3, 2018 and confirmed Sergeant Weidner is his normal assigned supervisor.

I asked Deputy Watt if he received a full night's sleep prior to beginning his shift on October 3, 2018. Deputy Watt said he typically goes to sleep at approximately 10:30 PM to 11:00 PM and wakes up by approximately 3:00 AM to 3:15 AM on the mornings he works and confirmed this was what he did in his sleep cycle before starting his shift on October 3, 2018. Deputy Watt said his normal routine includes going to the gym each morning to work out from approximately 4:00 AM to 5:00 AM and then he reports directly to the Millbrae substation where he showers and gets ready for his shift. Deputy Watt stated he was not under the weather or taking any medications on October 3, 2018. I asked Deputy Watt if he took any prescription medications which might affect his reaction times or impair his abilities in any way and he stated he did not take any such medications. Deputy Watt described his off hours after his shift on October 2, 2018 as consisting of having gone home, watched television and ate dinner. Deputy Watt stated he did consume one (1) beer after getting off work on October 2, 2108.

**CONTROLLED DOCUMENT**

Prepared By:  
80205 DRAPER, JAMIE

Date:  
10/12/2018

Approved By:  
80240 WARREN, JOHN

Date:  
12/18/2018



**CONTROLLED DOCUMENT**

Deputy Watt discussed his activity earlier in his shift on October 3, 2018. Deputy Watt said the deputy assigned to the Millbrae beat for the shift was Deputy Alyssa Lorenzatti and explained she was in a training at the beginning of the shift so he was covering the Millbrae beat during the first several hours of his shift. Deputy Watt described a call for service in Millbrae at around 8:00 AM in which he was dispatched to a report of a suspicious person walking on El Camino Real. Deputy Watt said the subject was a transient female and it was ultimately determined she had just been released from Mills-Peninsula Hospital. Deputy Watt stated due to the subject's demeanor initially, she was placed in handcuffs; however, she was ultimately released without incident. I asked Deputy Watt to better describe the subject's demeanor and he said the subject was agitated and refused to stop. Deputy Watt said Deputy Wang and Deputy Sanders were on scene ahead of him and were in the process of handcuffing the subject when he arrived. Deputy Watt described the female as being mentally ill, but not to the point of needing to be committed at the time and stated she was yelling and her pants had had fallen to the ground when he arrived. Deputy Watt said he talked with her and was able to calm her down while he was on-scene and learned she had discharge paperwork in her possession showing she had been released from the hospital that morning.

Deputy Watt said he next attempted to contact a subject who was smoking on the platform at the BART Station. Deputy Watt said the subject walked away from him and then pushed a bicycle at him while they both rode up on an escalator within the station. Deputy Watt said the subject had positioned the bicycle between them while going up the escalator and Deputy Watt said he grabbed the bicycle, at which time the subject let it go causing it to come down on Deputy Watt but did not knock him down. Deputy Watt said he pushed the bicycle out of his way and was able to grab the subject to place him in a control hold. Deputy Watt said once he grabbed the subject, the subject immediately complied and sat down. Deputy Watt said the subject was then found to have numerous warrants for his arrest out of multiple jurisdictions and was placed under arrest without any further incident. Deputy Watt described the rest of his shift as consisting of a "few traffic stops" after the incident at the BART station and prior to the incident on the 1400 block of El Camino Real. Deputy Watt said a driver in one of these stops did refuse to sign the traffic citation which required him to call Sergeant Weidner. Deputy Watt said Sergeant Weidner responded and convinced the subject to sign the ticket without incident.

I asked Deputy Watt to walk me through the incident which occurred in the 1400 block of El Camino Real on October 3, 2018. I asked Deputy Watt to start with the point he first became aware of the radio traffic up to the point he was relieved at the scene. Deputy Watt told me he was at the Millbrae Police Substation and was on the phone doing follow-up work on an unrelated case. Deputy Watt said he had seen Deputy Wang leave the substation but did not hear any call for service coming out. Deputy Watt said he was just finishing up his phone call when he heard Deputy Wang asking for another unit. Deputy Watt said Deputy Lorenzatti got up to leave the substation to cover Deputy Wang and then he heard Deputy Wang broadcast again asking for "code 3 cover". Deputy Watt said he was the last of the deputies to leave the report writing room at the substation and he responded to his patrol vehicle and

Prepared By:  
80205 DRAPER, JAMIE

Date:  
10/12/2018

Approved By:  
80240 WARREN, JOHN

Date:  
12/18/2018





responded, "code three" (lights and sirens activated) to Deputy Wang's location.

Deputy Watt said as he arrived in the area, he saw "at least two (2), if not three (3)" marked patrol vehicles in the southbound lanes of traffic on El Camino Real in front of a bank. Deputy Watt said he pulled his patrol vehicle along-side one of the patrol vehicles and behind another patrol vehicle. Deputy Watt said he exited his patrol vehicle and saw a deputy who he could not identify in what he described as the number 3 lane of traffic on El Camino Real. Deputy Watt said he also saw the subject in the same lane of traffic. Deputy Watt said as he came up, he realized the subject had already been "tased" because he could see the probe wires connecting from the subject to Deputy Wang's Taser. Deputy Watt said the subject was on the ground, laying on his back and he could hear Deputy Lorenzatti and Sergeant Weidner trying to convince the subject to roll over on his stomach. Deputy Watt said he saw "somebody" try to grab the subject's hand, but the subject pulled his hand away. Deputy Watt said he noted one (1) prong from a Taser in the back of what he believed was the subject's left hand; however, said he was unsure exactly which hand the probe was in.

Deputy Watt described the subject as not physically resisting while he was on the ground, but was also not complying with the verbal commands which were being given to him. Deputy Watt said he believed he and the other deputies on-scene would be attempting to put handcuffs on the subject so he pulled gloves out and was putting them on. While he was putting the gloves on, Deputy Watt said the subject was "becoming more and more agitated" and started "rolling around". Deputy Watt said he reached out to try and grab ahold of the subject's hand, but the subject kept pulling his hand away. Deputy Watt said the subject then got back up on his feet at which time, Deputy Watt said he drew his ASP and extended it, but did not strike the subject with it. Deputy Watt recalled another deputy (he could not recall which one) then tried again to grab the subject, but described the subject as having "flailed away" from the deputy. Deputy Watt then described the subject as moving south-east across the lanes of traffic into the northbound lanes and said he was attempting to parallel the subject as he moved locations. Deputy Watt did recall Deputy Wang deploying another Taser activation which took the subject to the ground at one point prior to them moving across the street. Deputy Watt said the activation seemed to only be effective for a "second or two" and described the subject as having been "able to fight through that".

Deputy Watt said once they were in the northbound traffic lanes, Deputy Wang approached the subject again and appeared to be trying to subdue the subject. Deputy Watt said the subject appeared to be trying to tackle Deputy Wang and he saw the subject had his hands around Deputy Wang's waist. Deputy Watt said he was "pretty sure" Deputy Wang struck the subject at least once with his baton at that point in time and Deputy Wang appeared to have been able to break free of the subject's hold. Deputy Watt said Deputy DeMartini was then able to tackle the subject and take him to the ground. Deputy Watt said he and the other deputies on scene converged on the subject and each tried to get ahold of different body parts to get him under control and place him in handcuffs. Deputy Watt described the subject as "flailing around" and said the subject was able to turn over nearly back to being on his back again during the struggle. Deputy Watt said the subject was on his side when "somebody deployed OC and I took a shot

**CONTROLLED DOCUMENT**

Prepared By: 80205 DRAPER, JAMIE	Date: 10/12/2018	Approved By: 80240 WARREN, JOHN	Date: 12/18/2018
-------------------------------------	---------------------	------------------------------------	---------------------



**CONTROLLED DOCUMENT**

of it right in the face from about a foot away”. Deputy Watt said had to back away from the attempts to get the subject under control once he was hit with the pepper spray because he was unable to see. Deputy Watt explained that a Millbrae City Worker then arrived on scene and assisted him in flushing his eyes with water. Deputy Watt said this enabled him to try and assist in getting the subject under control. Deputy Watt recalled giving “somebody” his handcuffs and then recalled the subject being handcuffed with two (2) sets of handcuffs and being turned on his side. Deputy Watt said he then assisted in getting the subject up into a seated position and using his leg as a chair back to help the subject sit up. Deputy Watt said he stayed in that position assisting the subject in sitting up for approximately “a minute or two” until he was relieved by another deputy. Deputy Watt said he then went back to getting water to flush his eyes out and was away from the subject’s location.

I asked Deputy Watt if he ever heard a broadcast providing a description of the subject when he was first arriving to cover Deputy Wang. Deputy Watt said he did not recall ever hearing any description being given of the subject prior to his arrival on-scene. Deputy Watt said the very first time he saw the subject, the subject was already on the ground. Deputy Watt said he determined this was the subject because he was on the ground with Taser probes sticking out of him. Deputy Watt said he had no information as to why the subject was being detained at that point in time. Deputy Watt said his goal was to assist his partners in getting a subject in-custody who had been struck with a Taser. Deputy Watt said he did try to verbally engage the subject upon arrival, including telling the subject to “roll over on his stomach” and telling the subject he would be “tased again” if he did not “lay on his stomach”.

I asked Deputy Watt to describe to me any observation he may have had regarding the subject. Deputy Watt described the subject as “a big person” and estimated the subject was approximately six foot to six foot three inches in height and weighed “at least three hundred pounds”. Deputy Watt recalled the subject was yelling, but the only words he could recall the subject saying was something similar to “get them off me” or “get them out of me” and believed the subject was talking about the Taser prongs. Deputy Watt also recalled the subject as “growling and grunting” during the incident as well. Deputy Watt said he first believed the subject was possibly “5150”, but after observing the subject’s strength and the way he was fighting off the attempts to get him under control, Deputy Watt said he then believed the subject was under the influence of a controlled substance. I asked Deputy Watt if he had prior experience and training in recognizing symptoms of controlled substance influence and he stated he had been to a three (3) day school put on by the San Mateo County Narcotics Task Force and also had twenty (20) years of experience dealing with persons under the influence of controlled substances. I asked Deputy Watt if he had ever seen this subject previously and Deputy Watt said he did not believe he had ever seen the subject before.

I asked Deputy Watt if he could see what the subject was grabbing when he was trying to tackle Deputy Wang. Deputy Watt said he could see the subject had his hands near Deputy Wang’s gun belt, but could not see what, if anything the subject had ahold of at the time. I asked Deputy Watt about his previous statement about Deputy Wang possibly striking the subject with the ASP. Deputy Watt said he saw

Prepared By: 80205 DRAPER, JAMIE	Date: 10/12/2018	Approved By: 80240 WARREN, JOHN	Date: 12/18/2018
-------------------------------------	---------------------	------------------------------------	---------------------





**CONTROLLED DOCUMENT**

Deputy Wang swing the ASP, but could not say if the subject was struck or not. I asked Deputy Watt if he ever saw the subject strike Deputy Wang. Deputy Watt said that shortly after the subject had grabbed Deputy Wang's waist area and Deputy Wang had been able to get free, he did see the subject throwing punches "in about the face" of Deputy Wang, but could not see if these punches connected or not. Deputy Watt said he did look away "a couple of times" as he was concerned about maintaining their safety with on-coming vehicular traffic in the roadway. I asked Deputy Watt about Community Service Officer Joey Gonzales' presence during the incident. Deputy Watt did recall seeing CSO Gonzales there at the end of the struggle and recalled CSO Gonzales attempting to assist them in getting the subject handcuffed. Deputy Watt said he grabbed CSO Gonzales and pulled him away from the struggle and told him to get back. Deputy Watt said he was then struck with the pepper spray (OC) around the time he pulled CSO Gonzales away from the attempts to get the subject under control.

I asked Deputy Watt about when he was helping the subject in a seated position and asked if he heard the subject saying anything at the time. Deputy Watt said he recalled the subject had his head down and was unsure if the subject was breathing because he was no longer moving around as he would have expected the subject to act after a struggle. Deputy Watt said he tried to check the subject for a pulse at the subject's neck and the subject suddenly brought his head up and was looking around and he could see he was breathing so he stopped trying to find a pulse. Deputy Watt said he was talking to the subject, telling him to relax and to breath but did not recall the subject ever saying anything in response. Deputy Watt said once he was relieved from holding the subject up, he went up to the area in front of CSO Gonzales' truck and got more water to rinse his face. Deputy Watt said he did see paramedics arrive and saw them treating the subject at one point and then looked over again at another point a short time later and saw the paramedics were giving the subject CPR. Deputy Watt added that when he was relieved by the deputy, he believed the relieving deputy used the same technique of propping the subject up in a seated position using a knee to hold him up. Deputy Watt said he believed it was one of the deputies from the San Mateo County Sheriff's Office Transit Bureau who relived him, but he could not recall which Deputy it was.

I asked Deputy Watt whether he wore any corrective lenses and Deputy Watt said he did not. Deputy Watt said the lighting conditions were good due to it being daylight hours at the time the incident took place and that until his being struck in the face with pepper spray, he had an unobstructed view of what was occurring during the incident. Deputy Watt did say there were times when he would focus his attention on passing vehicles or times when one of the other deputies might block his vision briefly during the struggle to control the subject, but nothing else effected his ability to see what was occurring. I asked Deputy Watt which portion of the body he was attempting to control during the final portion of the struggle and Deputy Watt said he was trying to control one of the subject's arms. Deputy Watt said Deputy Wang was at an area near one of the subject's shoulders, Sergeant Weidner was at the subject's waistline area, Deputy Lorenzatti was near the waistline or upper leg area of the subject and Deputy DeMartini was at the subject's feet. Deputy Watt said he believed he took the brunt of the pepper spray, but thought Deputy Lorenzatti and Sergeant Weidner were also struck with the pepper spray and were



affected by it.

I asked Deputy Watt if any other less-lethal weapons or control techniques were deployed on the subject once he was on the ground the final time in the northern lanes of traffic. Deputy Watt said he believed the subject was only shocked with the Taser two (2) times toward the beginning of the altercation when they were in the southbound lanes of traffic. Deputy Watt said he believed Deputy Wang struck the subject at least once in the lower extremities with the ASP while they both were still standing upright. Deputy Watt said the only other attempt he was aware of was the deployment of the pepper spray. I asked him whether there were ever any attempts by any of the deputies present to apply the carotid or vascular neck restrain (VNR) on the subject. Deputy Watt stated there was no attempt to utilize the carotid or vascular neck restrain (VNR) on the subject. Deputy Watt said he did not sustain any injuries during the incident other than the effects of the pepper spray.

Deputy Watt said he has been certified in Crisis Intervention Training (CIT), having attended the course in approximately 2009. Deputy Watt said he has used the techniques from CIT training effectively in his career since attending the course, but did not feel there was any opportunity to employ those techniques in this incident by the time he arrived on scene. I asked Deputy Watt to explain why he felt the techniques would not have worked and Deputy Watt told me due to the fact the subject was already actively in a fight, had been tased and was either "not listening, not hearing or didn't want to talk" all were factors as to why he did not believe the techniques learned in CIT training would have worked in this situation. Deputy Watt indicated he has had defensive tactics training and maintains those skills by attending regular, required training put on by the San Mateo County Sheriff's Office and has maintained other perishable skills as mandated by the California Commission on Police Officer Standards and Training (POST). Deputy Watt said in addition to his assignment as a patrol deputy, he is also a Field Training Officer (FTO) for the Sheriff's Office.

I asked Deputy Watt to describe some of the emotions or concerns he felt during the incident. Deputy Watt said he was concerned with the safety of himself and the other deputies, the safety of the public and on the safety of the subject they were attempting to detain. Deputy Watt said in his past experience, typically once subjects are placed in handcuffs they tend to calm down and be more compliant. I asked Deputy Watt if he felt this was a situation where he and the other deputies could have simply backed away and left the subject alone. Deputy Watt stated he did not believe this was a situation where that was an option and cited the fact the subject physically assaulted a deputy at one point and the fact there were pedestrians on the roadway. Deputy Watt added that the subject already expressed a willingness to fight with police officers, which made him unsafe to be in the general public in his opinion.

I resumed the interview after a short break and asked Deputy Watt some additional clarifying questions. I asked Deputy Watt a series of questions regarding whether he felt he and the other deputies could have "backed away" from the incident and just allowed the subject to walk away. I specifically asked Deputy Watt if he could have "backed away" when he first arrived on-scene. Deputy Watt said he could not

CONTROLLED DOCUMENT

Prepared By: 80205 DRAPER, JAMIE	Date: 10/12/2018	Approved By: 80240 WARREN, JOHN	Date: 12/18/2018
-------------------------------------	---------------------	------------------------------------	---------------------





CONTROLLED DOCUMENT

have "backed away" as the subject had already been "tased" and had the Taser probes still in him and added that the Sheriff's Office policy required them to get medical help for the subject once the Taser had been used. I asked him about the assault on the officer, something he mentioned previously as a reason for why the subject could not be allowed to walk away. Deputy Watt was able to confirm he was talking about the assault on Deputy Wang. He described the assault on Deputy Wang as occurring later in the incident, closer to the point when the subject was ultimately taken under control and placed in handcuffs. I asked Deputy Watt to better explain what he observed upon first arriving at the scene. Deputy Watt said when he first arrived, he could only see the other stopped patrol vehicles and assumed his fellow deputies were in front of the patrol vehicles. Deputy Watt said he then saw the back of one of the deputies (he could not be sure as to which one) in front of the vehicles as he exited his own patrol vehicle. Deputy Watt said that as he exited his vehicle and began heading toward the location of the patrol vehicles, he saw deputies moving from the area of the street nearest the sidewalk toward the lanes of traffic. Deputy Watt said he only saw other deputies at that point and the first time he came into view of the subject, the subject was already lying on his back on the ground. Deputy Watt said he could see the wires coming out of the Taser and immediately assumed the Taser had been deployed at the subject. Deputy Watt said he then saw the one (1) probe from the Taser in the back of one of the subject's hands. Deputy Watt said he never saw where the second probe struck the subject. Deputy Watt said he did not initially hear any noise from the Taser, but believed he may have heard the noise from the second activation of the Taser, indicated by the subject falling to the ground as second time.

I specifically asked Deputy Watt if he ever used his own ASP, Taser or pepper spray on the subject. Deputy Watt stated he did not ever use any of those items. He clarified, that he had drawn his ASP, and extended it, but he did not strike the subject with it at any time. Deputy Watt also denied ever striking or hitting the subject and stated his only contact with the subject was his attempts to physically restrain him. I asked Deputy Watt if, when the subject was on the ground the final time, whether he observed if the Taser probes were still in the subject. Deputy Watt said he did not notice if the probes were still in the subject or not.

At the culmination, I allowed Gregory Thoming to ask any clarifying questions he might have for Deputy Watt. Thoming asked Deputy Watt if, based upon his twenty-three (23) years with the Sheriff's Office, if Deputy Watt did anything outside of policy or what he has been trained to do. Deputy Watt stated "no". Thoming asked Deputy Watt if he observed his fellow deputies do anything "like that" and Deputy Watt stated "no". Thoming also confirmed with Deputy Watt that he had spoken with the subject during this incident and had made attempts to calm the subject and gain his compliance. Thoming asked Deputy Watt if he ever heard other deputies attempting to speak with the subject and calm him and gain his cooperation. Deputy Watt stated "yes".

**Disposition:**

Attach to original report.



**SAN MATEO COUNTY DISTRICT ATTORNEY'S OFFICE**

Page 9

400 COUNTY CENTER, 3RD FLOOR REDWOOD CITY, CA 94063 650-363-4636

**SUPPLEMENT 10 - Interview of Deputy Bryan Watt**

18-1003-02

**CONTROLLED DOCUMENT**

Prepared By:

80205 DRAPER, JAMIE

Date:

10/12/2018

Approved By:

80240 WARREN, JOHN

Date:

12/18/2018

**INTERVIEW WITH BRYAN WATT**

**Q=Ins. Jamie Draper**

**A=Bryan Watt**

**A1=Atty. Greg Thoming**

1  
2  
3  
4  
5  
6  
7 Q: It's a little bit like a vacuum in here when that thing closes. Don't want to get  
8 too interrupted. For some reason I thought I brought this in already. Okay.  
9 And so the recorder is rolling now.

10  
11 A: Okay.

12  
13 Q: Just so you know. And, uh, just for the - like the record at the beginning I  
14 want to identify ourselves on the record. So I'm Inspector Jamie Draper with  
15 the DA's office.

16  
17 A1: Greg Thoming with Mastagni representing Deputy Watt this afternoon.

18  
19 A: I'm Bryan Watt with the San Mateo County Sheriff's Office.

20  
21 Q: Um, so for a portion of the interview I'm really gonna be kinda relying off a  
22 kind of checklist and asking you some questions kinda from the checklist. So  
23 you'll see me kinda looking down periodically and asking some questions.  
24 Um, I'm not - I don't want act - come off like I'm rude or not making eye  
25 contact or anything like that. I'm just tryin' to make sure that we get through  
26 certain questions that we have. So don't feel like you have to necessarily stop  
27 talking if I look away or, you know, anything like that. Just making sure we  
28 cover all the bases on there. Um, and I should add that the date and time is  
29 October 5, 2018 at 11:05. And one of the things I want to start with is the fact  
30 that, um, you're here voluntarily for this interview. Nobody has ordered you  
31 from the Sheriff's Office to be here and to provide a statement and that you've  
32 discussed this with your attorney.

33  
34 A: I have.

35  
36 Q: Okay. Um, start with - okay, you work for the Sheriff's Office. How long  
37 have you worked there?

38  
39 A: Uh, with the Sheriff's Office for a little over 23 years.

40  
41 Q: And how long of that was as a deputy as opposed to a correctional officer?

42  
43 A: I was a correction officer for right around five and I've been a deputy since,  
44 uh, December of 2000. So I'm comin' up on 18 years now.

45

46 Q: Okay.  
47  
48 A: A little under 18 years.  
49  
50 Q: Have you ever worked for any other law enforcement agencies?  
51  
52 A: No, I have not.  
53  
54 Q: Okay. Um, do you have any prior law enfor-, or prior, um, military  
55 experience?  
56  
57 A: No.  
58  
59 Q: Okay. Any prior jobs like security or loss prevention or anything like that  
60 before...  
61  
62 A: No.  
63  
64 Q: ...law enforcement? Okay. Um, during your time at the Sheriff's Office what  
65 are some of the assignments that you've - you've worked?  
66  
67 A: I've worked the jail, um, and patrol for the most part...  
68  
69 Q: Okay.  
70  
71 A: ...throughout my career. Um, really short stint over in courts trans-, over in  
72 courts and transportation.  
73  
74 Q: Okay. And where are you currently assigned?  
75  
76 A: I'm assigned to, uh, patrol in the - out of the Millbrae area or the Millbrae  
77 substation.  
78  
79 Q: Okay. And that's the Millbrae Patrol Bureau I believe is the official name?  
80  
81 A: Yeah, the Millbrae Patrol Bureau, correct.  
82  
83 Q: Okay. Uh, do you have any secondary employment or employment outside of  
84 this job?  
85  
86 A: No.  
87  
88 Q: Okay. Do you attend school or anything outside of the job?  
89  
90 A: No.

91  
92 Q: Okay. Are you left handed or right handed?  
93  
94 A: I'm right handed.  
95  
96 Q: Okay. I wanna talk about your, um, your duty belt...  
97  
98 A: Uh-huh.  
99  
100 Q: ...arrangement. And do you carry an outer carrier or...  
101  
102 A: Yeah, right...outer carrier.  
103  
104 Q: Okay, we'll start with the vest then.  
105  
106 A: Okay.  
107  
108 Q: What items do you carry on you vest and where are they on the vest?  
109  
110 A: Um, I carry pepper spray and an ASP and they are on my left side.  
111  
112 Q: Okay.  
113  
114 A: Um, my magazines are kinda in the center.  
115  
116 Q: Okay.  
117  
118 A: I carry a secondary firearm in a pouch on the right hand side and it's with a  
119 left hand draw.  
120  
121 Q: Okay.  
122  
123 A: Um, that's - other than that notebooks and a tourniquet and stuff like that.  
124  
125 Q: That are all in the carrier?  
126  
127 A: Right.  
128  
129 Q: And what items are on your belt?  
130  
131 A: My belt is just my Taser and my firearm.  
132  
133 Q: Okay. And what side do you carry your firearm on?  
134  
135 A: It's on my right side.

136  
137 Q: And your Taser?  
138  
139 A: On my left side.  
140  
141 Q: Okay. And handcuffs?  
142  
143 A: Oh, handcuffs I carry - I do carry a pair of handcuffs on my duty belt right  
144 behind my firearm and I carry a pair of handcuffs on my vest on the front  
145 portion.  
146  
147 Q: Okay. So two pairs of handcuffs. Any other equipment that you can think of?  
148 Radio obviously.  
149  
150 A: And a radio on my vest also. Um, I carry a window punch on my vest to break  
151 out windows if necessary. Um, what's on my vest.  
152  
153 Q: Pocket knife or anything like that?  
154  
155 A: Carry a pocket - I carry a folding knife that's usually in my ASP pocket on the  
156 back of my pants.  
157  
158 Q: Okay.  
159  
160 A: Um, keys on my vest and on my belt.  
161  
162 Q: Okay. Gloves?  
163  
164 A: Gloves in my back pocket also. Also gloves in a pouch on my vest.  
165  
166 Q: Okay. Disposable type or...  
167  
168 A: Disposable gloves on my vest. I carry leather gloves in my back pocket.  
169  
170 Q: Okay. What time did, uh, your shift begin on - it's Wednesday now.  
171  
172 A: At 0600 hours.  
173  
174 Q: Okay. And what time do you normally get off?  
175  
176 A: Uh, 0600 - or I'm sorry 1800 hours.  
177  
178 Q: Okay. So 6:00 am to 6:00 pm. And that is your normal...  
179  
180 A: Yes.



181  
182 Q: ...patrol shift? Um, what day of the week was it for you?  
183  
184 A: Uh, I think today's Friday so it woulda been - it woulda been a - it was  
185 Wednesday. It was our first day of the - of the tour basically.  
186  
187 Q: So it was your first day?  
188  
189 A: Yeah.  
190  
191 Q: Of that rotation? Cause I understand it's rotating days off?  
192  
193 A: Right, yeah. We work two on, two off every other weekend for three days.  
194  
195 Q: Okay. Um, and that is your normal assignment...  
196  
197 A: Correct.  
198  
199 Q: ...where you work. Um, were you working overtime in the days preceding to  
200 that or the night preceding?  
201  
202 A: Um, yes I worked overtime both the days off so I worked overtime on  
203 Monday and Tuesday.  
204  
205 Q: Okay. And where did you work that overtime?  
206  
207 A: Um, have to look at my phone. When I've - Monday - I believe Monday I  
208 worked patrol out of Millbrae and I think Tuesday I worked transportation.  
209  
210 Q: Okay. And what hours were those if you...  
211  
212 A: Um, if it was patrol on Monday it woulda been 6:00 am to, uh, to 6:00 pm.  
213  
214 Q: Okay.  
215  
216 A: Um, and transportation would have been 7:00 to 5:00.  
217  
218 Q: 7:00 am.  
219  
220 A: 7:00 am - 5:00 pm.  
221  
222 Q: Okay. Um, are you assigned to a specific beat within the Millbrae Patrol  
223 Bureau?  
224  
225 A: I am. I work the north county - the unincorporated north county beat, the 60

226 beat.  
227  
228 Q: Okay. So you would not have actually been assigned within the city limits of  
229 Millbrae but to the unincorporated areas outside of Millbrae?  
230  
231 A: Correct.  
232  
233 Q: Okay. And the 60 beat covers more of the north area?  
234  
235 A: It covers roughly everything from 92 North to San Francisco.  
236  
237 Q: Okay.  
238  
239 A: And little pockets in between.  
240  
241 Q: Does that include the like Eichler Highlands and...  
242  
243 A: Eichler Highlands, um, like the - like the 280 corridor. We got a portion in  
244 Colma, portion in South City, San Bruno Mountain.  
245  
246 Q: Okay. Um, were you driving your normal patrol vehicle that day or do they  
247 kinda just whatever's available?  
248  
249 A: Um, I have an assigned vehicle and I was driving my assigned vehicle...  
250  
251 Q: Okay.  
252  
253 A: ...for my shift. Other people do drive it when I'm not there but...  
254  
255 Q: Okay. Um, tell me about your uniform that you were wearing that day? We  
256 talked about the outer carrier a little bit...  
257  
258 A: Right.  
259  
260 Q: ...but describe everything on it with insignias and everything.  
261  
262 A: Um, I was wearing a full Sheriff's Office uniform. Um, I had the wool pants  
263 on with the wool shirt. Um, I was wearing a short sleeve shirt. I was wearing  
264 outer carrier. My shirt had patches on it - both - both sleeves. I was wearing  
265 my outer carrier. On my outer carrier I do have a badge and a nametag affixed  
266 to it. Uh, both - both brass - the brass nametag.  
267  
268 Q: Okay. So the metal badge as opposed to the embroidered patch?  
269  
270 A: The metal - correct.

271  
272 Q: Okay. Is there anything on the back of those vests?  
273  
274 A: Um, there's not - well there is but it was tucked in. It's, uh, something you can  
275 pull - pull out and it'll say sheriff on the back but that was tucked in...  
276  
277 Q: Yeah, but that was not out.  
278  
279 A: ...at the time.  
280  
281 Q: Okay. And that's typically how you would wear it...  
282  
283 A: Wear it for patrol uniform.  
284  
285 Q: Okay. Were you assigned solo to your vehicle or was there a partner with  
286 you?  
287  
288 A: Solo.  
289  
290 Q: Okay. And that's typically the way it's done?  
291  
292 A: Yeah.  
293  
294 Q: Who was your direct supervisor for that shift?  
295  
296 A: Would have been Sergeant David Weidner.  
297  
298 Q: And he is your normal...  
299  
300 A: Yes.  
301  
302 Q: ...direct supervisor?  
303  
304 A: Correct.  
305  
306 Q: We already talked about your normal shift. You said you'd worked overtime  
307 in transportation the day before, correct?  
308  
309 A: Yeah. Can I check my phone just to make sure?  
310  
311 Q: Yeah that's - that's...  
312  
313 A: I know I worked overtime both days. I want to make sure I didn't flip-flop the  
314 days. Pull up my calendar. Yes, I worked Millbrae on Monday and  
315 transportation on Tuesday.

316  
317 Q: And you got off at 5:00 pm on Tuesday?  
318  
319 A: Thereabouts, yes.  
320  
321 Q: Okay. Um, so you had time to sleep before the end of that shift and the  
322 beginning of your normal Wednesday shift?  
323  
324 A: Yes.  
325  
326 Q: How many hours of sleep do you think you got between those two?  
327  
328 A: Um, I probably went to bed about - usually about 8:30, 9 o'clock at night and  
329 I usually get up about 3:00-3:15 in the morning. So roughly seven hours I  
330 guess.  
331  
332 Q: Okay.  
333  
334 A: If I did my math correctly.  
335  
336 Q: And, uh, you would've gotten up at 3:15 approximately in the morning?  
337  
338 A: Yeah, I would've. I got up at 3:15, yes.  
339  
340 Q: Okay. What time do you get to, um, wherever you - do you report directly to  
341 Millbrae?  
342  
343 A: Yeah, I - my - kinda my morning entails me going to the gym. I usually get to  
344 the gym around a little after 4:00. Work out 'til about 5:00 and then I get to  
345 Millbrae about 5:00 where I take a shower and get ready for work.  
346  
347 Q: Okay. And, um, how were you feeling that day? No illnesses or under the  
348 weather or anything?  
349  
350 A: No.  
351  
352 Q: Okay. And were you taking any medications or anything?  
353  
354 A: No.  
355  
356 Q: Okay. Do you normally take any prescribed medications?  
357  
358 A: Um, I take [REDACTED] once a night. It's for [REDACTED].  
359  
360 Q: Okay. Is that anything that would affect your ability to perceive anything or

361 your reaction times?

362

363 A: No.

364

365 Q: Um, while you were off between your last day of overtime on transportation  
366 and your Millbrae shift did you do anything eventful during your time off?

367

368 A: No, I went home. Probably had dinner and watched TV and then went to bed.

369

370 Q: Did you have anything to drink that night?

371

372 A: Uh, no.

373

374 Q: Okay.

375

376 A: I mean did...water.

377

378 Q: Yeah, no - no alcohol.

379

380 A: Yeah, no.

381

382 Q: Okay.

383

384 A: You know I take that back. I did have a beer when I got home.

385

386 Q: Okay.

387

388 A: Just one beer.

389

390 Q: Just one?

391

392 A: Yeah.

393

394 Q: And that would've been close in time to when you got off?

395

396 A: I probably had it about 5:00-5:30.

397

398 Q: Nothing that you would've been feeling the effects of the next day?

399

400 A: No.

401

402 Q: Okay. Um, let's talk about your - your shift now, from once you went 10-8  
403 from Millbrae that morning. Um, how was your shift prior to this incident  
404 which started at 1 o'clock? Was there anything significant that - or high stress  
405 that occurred during that shift?

406  
407 A: Um, yeah, um, we had a - we had a - the normal - the Millbrae cover deputy,  
408 which would've been Deputy Lorenzatti, she had training 'til noon so I was  
409 kinda in Millbrae covering her spot 'til about noon.  
410  
411 Q: Okay.  
412  
413 A: Um, at around - I forget the exact time - about 8:00ish in the morning, uh, we  
414 got a call of a suspicious person walking down El Camino. Um, turned out it  
415 was a - it was a transient that had got released out of the hospital and, uh, we  
416 ended up putting her in handcuffs for a minute just due to her demeanor at the  
417 time. Uh, once we - everything was fine she got released and got back on the  
418 BART or went back towards BART. Um, shortly after that, um, I observed a  
419 subject at the Cal Train Station that was smoking on the platform which is  
420 against the law. Um, I approached him. Um, during the time when I was tyrin'  
421 to identify myself, um, he tried to walk away from me. Um, we ended up, uh,  
422 goin' up the escalator where he pushed a bicycle at me. Um, I ended up havin'  
423 to put him into a control hold and wait for cover to be before I put him in  
424 handcuffs. Turned out he had a couple warrants and ended up going to jail for  
425 - for resisting arrest and the warrants. Um, and then, um, forget what I did.  
426 Two other traffic stops and then, uh...  
427  
428 Q: And those traffic stops were normal routine...  
429  
430 A: Yeah, um, well one of 'em refu-, refused to sign the ticket so I had to call my  
431 sergeant out, um...  
432  
433 Q: And that's Sergeant Weidner?  
434  
435 A: Sergeant Weidner, right. Ended up talking him into signing the ticket. Um, so  
436 that was a little, uh, not as normal as a normal traffic stop but...  
437  
438 Q: Okay.  
439  
440 A: ...other than him just not wantin' to sign the ticket. There was no - no other  
441 issues with that.  
442  
443 Q: Okay. And what was your call sign that day?  
444  
445 A: I was 2 Boy 60.  
446  
447 Q: Okay. And that corresponds with the beat that you were assigned?  
448  
449 A: Correct.  
450



451 Q: The 60 beat?  
452  
453 A: The 60 beat, correct.  
454  
455 Q: Okay. Um, goin' backwards a little bit to the two contacts that you had with  
456 the...  
457  
458 A: Uh-huh.  
459  
460 Q: ...transient female.  
461  
462 A: Right.  
463  
464 Q: Um, you talked about her demeanor. What was it about her demeanor?  
465  
466 A: Um, I - I got there third, um, and as I was getting there she was agitated,  
467 refused to stop. Um, at that time Deputy Wang and Deputy Saunders were in  
468 the process of putting her in handcuffs. Um, she was yellin'. Her pants  
469 weren't necessarily around her waist. They had fallen down to the ground.  
470 Um, we sat her down. I started talkin' with her and she calmed down and  
471 turns out she was maybe a little bit 5150 not to the point where she had to go  
472 to the hospital but...  
473  
474 Q: And you mentioned that she had been released from.  
475  
476 A: She had been released from a hospital, um, that morning at some point. I don't  
477 remember - I don't know the time but that morning she had paperwork to...  
478  
479 Q: From Peninsula?  
480  
481 A: From Peninsula Hospital...  
482  
483 Q: Okay.  
484  
485 A: ...saying she had got released.  
486  
487 Q: Um, do you know if that was on a 5150 hold that she'd been there on?  
488  
489 A: I don't know. I don't know.  
490  
491 Q: Um, and then the - the incident on the platform.  
492  
493 A: Correct.  
494  
495 Q: Uh, you talked about him...

496  
497 A: Sorry.  
498  
499 Q: ...kinda pulling away from you. There's flies that come through here so...  
500  
501 A: That's okay.  
502  
503 Q: Um, I'm tryin' to get rid of them. Um, you kinda went over when he went up  
504 the escalator you went up the escalator. You said we. Is that - was it just the  
505 two of you at that point?  
506  
507 A: Just me and him at the time.  
508  
509 Q: Okay. And he pushed a bike at you? Threw a bike at you?  
510  
511 A: Yeah he - he didn't throw it. We were goin' up the escalator and, um, as I  
512 grabbed his - he had positioned a bike in between us.  
513  
514 Q: And did he - was the bike his?  
515  
516 A: The bike was one of those rent - rental bikes.  
517  
518 Q: Okay.  
519  
520 A: Uh, I think it was a Ford Rental Bike or whatever they call 'em. One of the  
521 city kinda app bikes.  
522  
523 Q: Okay.  
524  
525 A: Um, he had that positioned in between us and - and he wasn't running. He  
526 wasn't being aggressive or anything. Just basically saying, "I'm leaving." Um,  
527 I grabbed a hold of the bike and he sort of let it go meaning since I was below  
528 him it kinda came down on me. I was able to push it out of the way relatively  
529 easy and went up and I grabbed him. When I grabbed him he sat back down.  
530 He just kinda sat on the floor. When we got to the top I kept a hold of him  
531 until my cover unit got there and then we put him in handcuffs.  
532  
533 Q: So you were able to get him in a control hold?  
534  
535 A: Yeah.  
536  
537 Q: An upward position. You didn't have to...  
538  
539 A: Um, he was - well he was seated. He had sat himself onto one of the steps...  
540

- 541 Q: Okay.  
542
- 543 A: As we got to the top - I basically told him on the way up I said, "As soon as  
544 we get up top you're gonna lay on your belly." And - and he did kinda on his  
545 side more for his belly and I just held him in that position until my cover unit  
546 got there and we were able to put him in handcuffs.  
547
- 548 Q: So resistant in the form of not tryin' to stay with you and...  
549
- 550 A: Right. Not fighting or anything like that but just not wanting to stay and let me  
551 either issue him a ticket or figure out what was goin' on.  
552
- 553 Q: Okay. Um, okay. Well that brings us up to now the incident that has us here  
554 today.  
555
- 556 A: Right.  
557
- 558 Q: My understanding it was about 1 o'clock. Um, what I'm gonna ask you to do  
559 is just essentially tell me the story, start to beginning from the time that you  
560 first hear something going on on the radio...  
561
- 562 A: Okay.  
563
- 564 Q: ...to kinda the point that you are essentially relieved or kind of extracted from  
565 being involved in it.  
566
- 567 A: Sure. Um, I was at the substation. Um, in fact we - the whole shift was at the  
568 substation. We had just finished eatin' lunch. It was right around 1:00. I don't  
569 know - remember the exact time. I was on the phone doing some follow-up on  
570 another case. Um, I saw Deputy Wang leave the substation. Um, I didn't hear  
571 the call come out on the radio. Um, as I was getting off my phone call, um, I  
572 heard him ask for another unit. Um, at that point Deputy Lorenzatti got up and  
573 started to leave, which was his partner at the time. Um, within a - probably a  
574 few seconds at that point I heard him ask for code three cover. At that point I  
575 left the - I was the last person out of - out of the report writing room which is  
576 where we were all at at the time. Got in my car. Responded to his location  
577 code three. Um, basically took El Camino from the substation to where he was  
578 at. Um, as I came into view of the incident I saw at least two if not three patrol  
579 cars over in the southbound lanes of El Camino Real almost right in front of  
580 the bank right there. I'm drawin' a blank on the name of the bank but it used  
581 to be the first something or other. Forgot the name of the bank but there's a  
582 bank right there. Um, I came across the lanes. Pulled my patrol car in next to  
583 one patrol car and then be - behind a third patrol car. Um, as I exited my  
584 patrol car, um, I proceed - I - I saw a Sheriff's Office deputy, and I don't  
585 remember who it was, just the back of it, and then the suspect had came and

586 was basically in the number three lane of El Camino Real. Um, that point I  
587 came up and I realized that he had been Tased. Um, I saw the - the - the cords  
588 coming out from him leading to Deputy Wang's Taser.  
589

590 Q: Was he on the ground or was he...

591  
592 A: He was on the ground on his back at that point. Um, Deputy Lorenzatti and it  
593 was Sergeant Weidner were tryin' to convince him to - to roll onto his  
594 stomach. Um, one point, um, I saw somebody try to grab his hand and he  
595 flailed his hand away not lettin' 'em grab his hand. Um, when I got into view  
596 of him I was kinda concentrating on his - I believe it was his left hand but I  
597 could be wrong on the hand. But um, it had a prong - prong stuck into his - the  
598 - the top of his hand. Um, I don't recall what side it was on his hand.  
599

600 Q: Okay.

601  
602 A: Um, I saw it had some blood comin' out of it. Um, he was on the ground and  
603 at that point and wasn't physically resisting but wasn't complying either. He  
604 wasn't rolling over. Um, I - I - at that point I put gloves on. Um, 'cause I had a  
605 feelin' we were gonna put him in handcuffs. Um, as I was getting gloves on  
606 he started becoming more and more agitated. He started yelling. Um, tried to  
607 get a hold of his hand a couple times in order to see if I can turn him over and  
608 put him in handcuffs and he kept pullin' his hand away from me. Um, during  
609 that whole process he had started getting back onto his feet. Uh, as he got onto  
610 his feet I stepped back a little bit. I did deploy my ASP, um, to the open  
611 position. Um, somebody tried to grab him and he flailed away from that  
612 person, that deputy. I don't remember who it was. Um, he kinda broke free of  
613 that. He - he saw me and he started to work his way - woulda been south in  
614 direction and also across El Camino Real, kinda away from me at that point  
615 and I tried to parallel him.  
616

617 Q: One thing I should ask and pause you for just a second. I'm sorry to interrupt  
618 your train of thought.

619  
620 A: No worries.  
621

622 Q: But I probably should have addressed before. I - this is my fault. But you did  
623 watch some video...

624  
625 A: Uh-huh.  
626

627 Q: ...of this incident and what videos did you watch?

628  
629 A: I watched my dash cam video from my police car.  
630

631 Q: Okay.  
632  
633 A: Um, and then I watched I believe it was a cell phone video from somebody  
634 that was in the bank.  
635  
636 Q: Okay. And what I'm gonna ask you to do too as you're telling the story is if  
637 it's something that you remember, you know, physically remember from not  
638 watching the videos to tell me or just to go ahead and keep telling me the  
639 story. But if it's something that you only remember because you saw it on the  
640 video please tell me that that's where you know it from as we go.  
641  
642 A: Okay. Um, basically I re-, everything I saw on the video was stuff that I  
643 remembered...  
644  
645 Q: Okay.  
646  
647 A: ...already. I didn't...  
648  
649 Q: But just if anything comes out that you...  
650  
651 A: Okay.  
652  
653 Q: ...go ahead and remember that but I saw it in the video and this is what I saw.  
654  
655 A: Absolutely.  
656  
657 Q: Just - just so we can kinda differentiate.  
658  
659 A: Okay. Okay. Um, and like I said I saw him started to work, um, his way sorta  
660 like southeast I would get to say across lanes of El Camino. Um, I kinda  
661 paralleled him, keepin' him from running in my direction. As we got into the  
662 northbound lanes of, uh, El Camino Real, I believe it was the middle lane, um,  
663 at that point, uh, I think it was Deputy Wang, um, tried to approach him again  
664 to take him to the ground. Oh, let me back up. Um, in between that process at  
665 some point, um, I believe Deputy Wang, um, gave him another, uh, forget the  
666 technical term, but another - another - not a Taser deployment meaning the  
667 full shot but another shock from the initial...  
668  
669 Q: Another activation.  
670  
671 A: Another activation. That's the word I'm looking for. Sorry. Um, gave another  
672 activation. Um, that did bring him to the ground but only for a brief second or  
673 two and then he was able to fight through that and stand back up. At that -  
674 that's about the time I deployed my ASP. Um, deployed it meaning extending  
675 it and having it in my hand. Um, and that's when he started running across El

676 Camino or moving across El Camino. Um, we kinda followed him. As we got  
677 to the - the northbound lanes of El Camino Real, I believe it was the number  
678 two lane about, um, Deputy Wang had approached him again and tried to take  
679 him down. Um, at that point he appeared to be tryin' to tackle Deputy Wang  
680 like grabbing him around the waist. Um, Deputy Wang I'm pretty sure struck  
681 him at least once with his baton. Um, kinda broke free of that. He then turned  
682 and started going kind of in a southeasterly direction again, um, until Deputy  
683 DeMartini tackled him basically from the side or the back which caused him  
684 to fall to the ground. At that point, um, we kinda all converged on him and,  
685 uh, tried to take - take pieces of him, you know, his hands and his feet and  
686 stuff like that in to control so we can put him in handcuffs. Um, he was  
687 flailing around. At one point he got almost back to his back - onto his back  
688 again. Um, he was on side. Um, that point somebody deployed OC and I took  
689 a shot of it right - right - right in the face from about probably less than a foot  
690 away. Um, I couldn't see at that point. Uh, not wanting to grab another deputy  
691 or anything else I backed - pulled myself outta the - outta the tussle for him.  
692 Um, a passerby - it was actually a public works guy that happened to be on the  
693 roadway gave me a bottle of water. I put some water - put some water on my -  
694 on my eyes. Um, by that point I kinda got back - went back over to them. We  
695 had sort of controlled his hand by that point where they were placing him in  
696 handcuffs. Um, I did give somebody my handcuffs. Um, next thing I  
697 remember is he was handcuffed with two pairs of handcuffs, um, and he was  
698 kinda on his side. Um, I assisted in sitting him into a - to a upright position, to  
699 a sitting position, um, using my leg as kinda like a chair back. I kinda kept  
700 him up in the sitting position, um, for a minute - minute or so until I was  
701 relieved by incoming units that were coming and at that point I kinda backed  
702 away from him and got some more water and was tryin' to flush my eyes out.

703  
704 Q: Okay. I'm gonna go back to just some things in there.

705  
706 A: Uh-huh.

707  
708 Q: Could be something that you said that I may have missed at the time so I may  
709 end up asking you to repeat something that I might have missed. Um, in your  
710 responding to the scene did you ever hear a description of the person being put  
711 out?

712  
713 A: Not that I recall.

714  
715 Q: When you did arrive on scene there were already at least a few deputies  
716 present.

717  
718 A: At least three if not four, yeah.

719  
720 Q: Um, and they were already engaged...



721  
722 A: Correct.  
723  
724 Q: ...with this person? He was already on the ground at that point in time or...  
725  
726 A: Um, when I first saw him he was on the ground.  
727  
728 Q: Okay.  
729  
730 A: Um, whether he was there when I first pulled up or not I'm not sure.  
731  
732 Q: Is that how you were able to identify who...  
733  
734 A: Yeah, he was the person on the ground with the Taser probes comin' out of  
735 him.  
736  
737 Q: Okay. And you didn't know - or did you know anything about why he was  
738 being detained or what the situation was?  
739  
740 A: I - I had - no I did not. Not 'til after the fact.  
741  
742 Q: Okay. And as you got there to assist what were you trying to accomplish?  
743  
744 A: When I got there I was tryin' to take him into custody. Um, I mean obviously  
745 there was something going on with him and my partners, um, to the point  
746 where they Tased him. Um, I - I was tryin' to verbally talk to him. I tried to  
747 verbally talk to him a couple times. Told him to just - just to lay on his, you  
748 know, to lay on his stomach. Um, you know, you're gonna get Tased again, I  
749 think I told him if you don't lay on your stomach. Um, I tried to grab his hand  
750 a couple times, um, just to put 'em behind his back as we're trained and put  
751 him in handcuffs.  
752  
753 Q: All right. Um, tell me about what you saw with this guy. What did he - kinda  
754 what'd he look like, um...  
755  
756 A: He was a big person. Um, guessing he was 6' to 6'3". Um, I'm puttin' him at  
757 least 300 pounds. Um, I mean he was - he was a big person.  
758  
759 Q: And, um, how was he reacting? Was he saying anything? Was he...  
760  
761 A: The only thing - he was yelling. The only thing I physically remember him or  
762 - remember him saying verbatim was - was like, "Get 'em off me. Get 'em off  
763 me," or, "Get 'em outta me." I believe he was talking about the Taser prongs.  
764  
765 Q: Okay.

766  
767 A: That's the only thing I remember him saying and he was growling and  
768 grunting and that type of stuff but only words I remember hearing were - was  
769 that.  
770  
771 Q: Um, did you perceive anything about him by this behavior?  
772  
773 A: Um, at - at - at first I thought he was, uh, maybe kinda 5150, um, when I first  
774 saw him. Um, after - as I was interacting with him more and - and just by his  
775 strength and his - way he was fightin' off our devices is I believe he was under  
776 the influence of some sort of a controlled substance.  
777  
778 Q: And do you have experience in identifying people under the influence of a  
779 controlled substance?  
780  
781 A: Yeah, I've been to - been to the, um, the three-day school through I believe it  
782 was our Narcotics Task Force. Um, I've also had 23 years of experience  
783 dealing with people that are intoxicated.  
784  
785 Q: Have you ever seen this guy before?  
786  
787 A: No, not that I remember.  
788  
789 Q: Um, you described a point where he was tryin' to grab Officer Wang...  
790  
791 A: Uh-huh.  
792  
793 Q: ...around the - the waist. Where did you see his hands at? What was he doin'  
794 with his hands?  
795  
796 A: I - I didn't - wasn't really paying attention to his hands. I saw him lunge at  
797 Deputy Wang and grab - he was - he was in the area of his gun belt, um, when  
798 he tried to grab him. That's all I remember.  
799  
800 Q: Um, and I know you talked about it a little bit and I think I got sidetracked  
801 with my train of thought about the video at this point. But you talked about  
802 Officer Wang deploying his ASP.  
803  
804 A: Correct.  
805  
806 Q: And you - you thought that he took a swing?  
807  
808 A: I thought he did as he was either coming at him or after he kinda tried to grab  
809 on him.  
810

811 Q: Did you - but you didn't see it connect or you're just not sure?  
812  
813 A: I'm not sure if it connected or not.  
814  
815 Q: Okay. And what did you see that happened right after that? Was there  
816 anything?  
817  
818 A: Um...  
819  
820 Q: Was that about the point that he tried to wrap him up around the waist or -  
821 Officer Wang around the wa-, Deputy Wang around the waist?  
822  
823 A: I - I don't remember the order to be honest with you.  
824  
825 Q: Okay.  
826  
827 A: I - I - I don't remember the order.  
828  
829 Q: Did you see him physically striking Officer Wang - Deputy Wang?  
830  
831 A: Yeah he did strike him a couple times. I believe it was after he tried to grab  
832 him around the waist, um, Deputy Wang was able to kinda fight off that part  
833 of it and he did throw punches at him, uh, in about the face. I don't know how  
834 many made contact with his face or anything like that. Um, we were also  
835 dodging cars so I was worried about cars driving down El Camino at the time  
836 so I - I did look away a couple times to make sure I wasn't gonna get hit by a  
837 car.  
838  
839 Q: Right. Um, during I think kinda that last point when he moved into the  
840 northbound lanes of traffic...  
841  
842 A: Uh-huh.  
843  
844 Q: ...kinda towards the end point of all this. There's a CSO truck...  
845  
846 A: Correct.  
847  
848 Q: ...there. Did - did you see the CSO at this point as well?  
849  
850 A: Um, the first time I remember seeing the CSO was after - after he had went to  
851 the ground for the - for the last time before when we took him into custody.  
852 The CSO had got out of his truck or was - was there somehow and was  
853 actually trying to help us. Um, I did - I remember grabbin' him and sayin',  
854 "Hey, get out. Get outta here." And kinda pushed him back off. And that's  
855 about the time I got hit with OC.

856  
857 Q: And this is Joey Gonzales?  
858  
859 A: Correct.  
860  
861 Q: Okay. And at some point obviously these - the city worker that you've talked  
862 about or the public works worker was also present at least providing you  
863 water.  
864  
865 A: Yes. Right exactly.  
866  
867 Q: Did you see that they were present at some point prior to this or...  
868  
869 A: There was a work crew working on the sidewalk over in front of the bank.  
870 Um, I can't say if they were - I don't remember what agency they're from. I  
871 don't know if they...  
872  
873 Q: Okay.  
874  
875 A: ...were Public Works or if it was Cal-Trans. I saw work trucks over there  
876 (unintelligible)...  
877  
878 ((Crosstalk))  
879  
880 Q: Okay. So you don't act-, even the person that was providing you water you're  
881 not sure where they were from?  
882  
883 A: Um, I know - I know he was from Public Works only 'cause I've seen him  
884 before.  
885  
886 Q: Okay.  
887  
888 A: Um, but as far as the other crew I don't remember where they were from.  
889  
890 Q: Um, you talked about sitting him up, kinda holding him up with your leg at a  
891 point.  
892  
893 A: Correct.  
894  
895 Q: Was he saying anything at this point in time? How was he acting?  
896  
897 A: No, he wasn't saying anything. In fact at - at - when I first pulled him up, um,  
898 his head was down. I remember reachin' in try to find a pulse, um, and he - he  
899 came back up and pulled his head up so I knew he was still breathing. That's  
900 what I was concerned about when I first pulled him over. I wasn't sure if he

901 had - if he was passed out or what was goin' on 'cause his head was not up or  
902 flailing around like I would expect it to be after somebody that just put up a  
903 fight like he did.  
904

905 Q: Okay.  
906

907 A: Um, I remember tryin' to reach in to see if I can get a pulse. Um, at that point  
908 he lifted his head up so I - I didn't - I stopped tryin' to take a pulse because he  
909 was moving his head around. Um, I don't believe he said anything. Um, I  
910 mean I was talkin' to him. I was just tryin' to tell him to relax, breathe. Um,  
911 and - and that's - he never said anything to me from that point on.  
912

913 Q: Was he breathing at that point in time?  
914

915 A: He was breathing when - when I was first there when he had - had moved his  
916 head up, yes.  
917

918 Q: Okay. So when he was sitting.  
919

920 A: Yeah, that would've - yeah.  
921

922 Q: And at some point somebody relieved you?  
923

924 A: Correct.  
925

926 Q: At that point. And did you kinda see what was going on with him after that  
927 point or did you...  
928

929 A: No I kinda walked away 'cause I - like I said I took a pretty good shot of OC -  
930 the gel OC. Um, I was - really wasn't seein' that well. Um, I did get some  
931 more water and I kinda remember walkin' around to the front of the CSO  
932 truck and, uh, dousing more water on my - my face and stuff.  
933

934 Q: At some point in time did you see that, um, paramedics had arrived to treat  
935 him?  
936

937 A: I saw paramedics arrived. I saw when the fire engine pulled up. Um, I heard it  
938 and could see that from where I was at. Um, but I did see them working on  
939 him. Um, and then I remember looking over at some point, probably a few  
940 minutes after that, and - and I watched as they were startin' CPR on him.  
941

942 Q: Okay. Um, when they first arrived do you know was he still seated up at that  
943 point or...  
944

945 A: Yes.

946  
947 Q: He was when the firemen...  
948  
949 A: Well I - I...  
950  
951 Q: As far as you know.  
952  
953 A: As far as I know. He was seated up. Uh, I - I gave - I don't remember what - it  
954 was a Transit deputy. I don't remember which one that showed up. Um, there  
955 were several of them there. I don't remember which one took - took over for  
956 me but he took my position. Um, I believe he used the same technique or was  
957 at least when I walked away.  
958  
959 Q: Okay. Um, talk a little bit about you again.  
960  
961 A: Uh-huh.  
962  
963 Q: Um, do you wear any corrective lenses, any glasses, contact lenses or  
964 anything like that?  
965  
966 A: No.  
967  
968 Q: Okay. So you have good vision?  
969  
970 A: Um-hmm.  
971  
972 Q: And the lighting conditions?  
973  
974 A: It was 1 o'clock daylight.  
975  
976 Q: Was there anything ever kind of obscuring your visibility to this incident?  
977  
978 A: Uh, not until the point I got OC'd.  
979  
980 Q: Okay. Maybe some of the bodies when they were piled on top of things? Was  
981 it hard to see everything going on?  
982  
983 A: Yeah, I mean - yeah I mean there was cars goin' by and you know there was  
984 people that would step in front of me and stuff like that but...  
985  
986 Q: While he was down on the ground, that's kinda the end point...  
987  
988 A: Uh-huh.  
989  
990 Q: ...um, and you talked about everybody kinda tryin' to grab a limb...



991  
992 A: Right, uh-huh.  
993  
994 Q: ...essentially. Uh, where were you tryin' to grab?  
995  
996 A: Um, I - I was tryin' to basically control one of his arms and how the body was  
997 - I can tell you the direction of the body but what - if it was his right or left  
998 arm I couldn't tell you.  
999  
1000 Q: Okay.  
1001  
1002 A: Um, it would've been on the - the north - north side of how he was layin'.  
1003  
1004 Q: And you've described kind of similar where everybody else was...  
1005  
1006 A: Right.  
1007  
1008 Q: ...tryin' to grab something?  
1009  
1010 A: Yeah, um, uh, Deputy Wang was more - I would say more at probably his -  
1011 one of his shoulders, um, across from me on the body. Uh, Sergeant Weidner  
1012 was about his waistline across from me. Um, Deputy Lorenzatti was - was  
1013 next to me probably about his waist or maybe even a leg and Deputy  
1014 DeMartini as at his feet.  
1015  
1016 Q: Okay. Um, other than you did anybody else also get pepper sprayed that  
1017 you're aware of?  
1018  
1019 A: Yeah, I - I think I took the brunt of it. I think there was some reflection off my  
1020 face that hit Deputy Lorenzatti that was sittin' next to me and also Sergeant  
1021 Weidner I believe he said he got a little douse of it also.  
1022  
1023 Q: You could hear them talking about this during the incident?  
1024  
1025 A: Right. And it was all verbally.  
1026  
1027 Q: Yeah. Not afterwards though but this was during the incident?  
1028  
1029 A: Right, during the incident.  
1030  
1031 Q: Yes.  
1032  
1033 A: Yeah.  
1034  
1035 Q: Um, were there any other attempts at force used to - other than control when

1036 he was down on the ground as far as was he Tased again, was he - I mean you  
1037 described that he was obviously pepper sprayed at some point.  
1038

1039 A: Right. Uh, um, right. Um, he - he - I - I know he was Tased at... a time before  
1040 I got there. Um, I believe he had one more activation put on him sometime  
1041 around the time he either was getting to his feet or had just gotten to his feet.  
1042 Um, I - I believe that was the last time he was, uh, the Taser was deployed on  
1043 him. Um, at least from my knowledge. Um, I know Deputy Wang struck him  
1044 at least once with a, um, a baton or an ASP. Um, it was towards the lower  
1045 extremities. Where exactly it hit I'm not sure.  
1046

1047 Q: And was he upright or down on the ground at that point?  
1048

1049 A: He was upright at that point.  
1050

1051 Q: Okay.  
1052

1053 A: Um, and then other than that - other than the OC when he was, uh, on the  
1054 ground that's it.  
1055

1056 Q: No attempts to do like a carotid restraint or anything like that with him?  
1057

1058 A: No.  
1059

1060 Q: Okay. That you saw?  
1061

1062 A: That I saw, right. Not that I did or I saw.  
1063

1064 Q: Okay. Um, we talked a little bit about your vehicle being an assigned vehicle.  
1065 Is it a marked vehicle?  
1066

1067 A: Yes.  
1068

1069 Q: Okay. Um, what type of car?  
1070

1071 A: It's an SUV... Explorer.  
1072

1073 Q: What color?  
1074

1075 A: Uh, it's white with a big blue stripe on it.  
1076

1077 Q: With the sheriff's markings?  
1078

1079 A: Yeah, it's vehicle 37 is the number of it.  
1080

1081 Q: And it's equipped with a MAV video?  
1082  
1083 A: It's equipped with a MAV video, correct.  
1084  
1085 Q: Um, does that have the remote microphone?  
1086  
1087 A: It used to. Um, it - it - I went on vacation about a week ago and it disappeared  
1088 sometime while I was on vacation.  
1089  
1090 Q: And the remote microphone goes with the vehicle, correct?  
1091  
1092 A: Correct. Um, um, I believe - I did tell my sergeant about it that morning. I  
1093 waited - I was hopin' it was gonna show back up. Um, I told my sergeant  
1094 about it that morning actually and I believe he sent an email out that morning.  
1095  
1096 Q: Sergeant Weidner?  
1097  
1098 A: Weidner asking for a new one for my vehicle.  
1099  
1100 Q: Okay.  
1101  
1102 A: So yes it is equipped but no I did not have it that day.  
1103  
1104 Q: And normally you would wear that somewhere on your person?  
1105  
1106 A: On my body, correct.  
1107  
1108 Q: Where would you wear that normally?  
1109  
1110 A: Um, my vest has two - two loops about the button line. One I carry my radio  
1111 on the other one I usually clip that on to it.  
1112  
1113 Q: Okay. Um, other than the effects of the pepper spray was there any other  
1114 injuries that you sustained during this?  
1115  
1116 A: No.  
1117  
1118 Q: No cuts, scrapes, bruises?  
1119  
1120 A: No.  
1121  
1122 Q: Soreness?  
1123  
1124 A: No, not really.  
1125

1126 Q: Okay. Were your uniforms damaged or anything at all other than pepper spray  
1127 saturation?  
1128

1129 A: Um, just the pepper spray and water from - from me dumping it on my face.  
1130

1131 Q: No rips or tears that you're aware?  
1132

1133 A: Not that I remember, no.  
1134

1135 Q: I mean I know we're in possession of it now.  
1136

1137 A: Right, yeah not that I remember.  
1138

1139 Q: Okay. Um, I want to talk a little bit about some of your training...  
1140

1141 A: Okay.  
1142

1143 Q: ...in the past. We talked a little bit about your ability for 11550 evaluations or  
1144 DRE. But um do you have any training in, um, like CIT?  
1145

1146 A: Yes. I've been to CIT. Went to CIT school 2009 maybe, somewhere around  
1147 there.  
1148

1149 Q: And you've used the techniques from that school in your job since then?  
1150

1151 A: Yes.  
1152

1153 Q: And successfully?  
1154

1155 A: Yes.  
1156

1157 Q: Did you feel there was an opportunity to use any of those techniques during  
1158 this?  
1159

1160 A: Not by the time I got there.  
1161

1162 Q: And how come?  
1163

1164 A: Um, he was actively fighting. He was already had been tased. Um, I mean it  
1165 was - he - I tried to talk to him. He was - wasn't - he wasn't listening, wasn't  
1166 hearing or didn't want to talk.  
1167

1168 Q: Okay. Um, and you've also had training in defensive tactics?  
1169

1170 A: Yes.

1171  
1172 Q: Um, and that's something that's done regularly, right?  
1173  
1174 A: Yes.  
1175  
1176 Q: How frequently?  
1177  
1178 A: Um, I'm not sure. I go when I'm told. Um, about once a year but I...  
1179  
1180 Q: Approximately?  
1181  
1182 A: Yeah.  
1183  
1184 Q: That's fine. Um, tactical communications?  
1185  
1186 A: Um, I've...  
1187  
1188 Q: ...verbal judo...  
1189  
1190 A: Yeah I - I mean through the academy, um, probably a few if not several times  
1191 throughout my career.  
1192  
1193 Q: I think there's a video that POST...  
1194  
1195 A: ...Video that POST makes you watch the video what, once a year now or once  
1196 every other year now.  
1197  
1198 Q: And you do that?  
1199  
1200 A: I have, yeah.  
1201  
1202 Q: Um, are you a trainer in any of these various techniques or anything?  
1203  
1204 A: Uh, I am an FTO but not in any of those various techniques.  
1205  
1206 Q: Not like a Taser...  
1207  
1208 A: Right.  
1209  
1210 Q: ...instructor or...  
1211  
1212 A: No.  
1213  
1214 Q: ...ASP instructor or anything like that?  
1215

1216 A: No.  
1217  
1218 Q: Okay. Um, do you have any involvement with like hostage negotiations or any  
1219 of that?  
1220  
1221 A: No.  
1222  
1223 Q: Okay. Um, you talked a little bit about kind of the need to get him wrapped up  
1224 and get him into custody and some of the concerns you, yourself had about  
1225 traffic...  
1226  
1227 A: Right.  
1228  
1229 Q: ...coming by and stuff. Um, did you have any other concerns going on while  
1230 this was occurring, things that you were feeling, emotions that you were  
1231 feeling?  
1232  
1233 A: No, I was just - I was worried about getting him into custody for our safety,  
1234 for the general public's safety and - and actually his safety. Once we get him  
1235 in the cuffs he's - in my experience people calm down and are - are a little  
1236 more willing to, you know, think it's over.  
1237  
1238 Q: Okay. Um, do you think it was a situation where you could've backed away  
1239 and let him go?  
1240  
1241 A: No, I don't. Not at - not at the point where I got there.  
1242  
1243 Q: Can you explain a little bit of why?  
1244  
1245 A: Um, well he had physically attacked a deputy already. Um, there was very  
1246 busy traffic on the street. There was pedestrians on the street. Um, if he's  
1247 willin' to fight with the deputies he's not safe to be in the general public in my  
1248 opinion.  
1249  
1250 Q: Okay. We're gonna take, uh, kind of a break for a couple minutes here...  
1251  
1252 A: Okay.  
1253  
1254 Q: ...I'm gonna confer with my supervisors and stuff and let you guys kinda  
1255 confer real quickly again and...  
1256  
1257 A: Okay.  
1258  
1259 Q: ...I'll come back in. I may have a few questions. I may not. We'll see. I  
1260 probably will have a couple more just little follow up things.



1261  
1262 A: Okay.  
1263  
1264 Q: But I'm gonna leave the video running in here so you guys will probably want  
1265 to go outside to...  
1266  
1267 A: Okay.  
1268  
1269 A1: Okay.  
1270  
1271 Q: ...to confer and I'll just keep the door closed.  
1272  
1273 A: Okay.  
1274  
1275 Q: I just have a couple of very brief things and I also wanna give your attorney a  
1276 chance to kind of clarify and ask some things if he chooses to do so as well.  
1277 Um, you talked about, um, when I asked you the question about could you just  
1278 let - back away and let him go.  
1279  
1280 A: Uh-huh.  
1281  
1282 Q: Um, you talked about he had already committed an assault on an officer.  
1283 Which point are you talking about when he committed the assault on the  
1284 officer?  
1285  
1286 A: Um, I guess depends on when you're talking about backing away.  
1287  
1288 Q: Right. Um, well let's - I guess maybe we'll break it down a little bit.  
1289  
1290 A: Uh-huh.  
1291  
1292 Q: How about at the point that you first arrive could you have just backed away?  
1293  
1294 A: No because he had two Taser prongs sticking out of him and, uh, I mean he'd  
1295 al-, he'd already been Tased once so, you know, per our policy we needed to  
1296 get him medical help and everything else so...  
1297  
1298 Q: So there would be a need to detain him...  
1299  
1300 A: Correct.  
1301  
1302 Q: ...at that point. And that would've continued as he kinda kept getting up?  
1303  
1304 A: Correct.  
1305

- 1306 Q: Um, and then I assume the assault on the officer that you're talking about is  
1307 Deputy Wang?  
1308
- 1309 A: Deputy Wang correct.  
1310
- 1311 Q: And that's kind of at the end?  
1312
- 1313 A: That's kinda the end to the middle. The middle - towards - yeah, I guess it  
1314 would be more towards the end.  
1315
- 1316 Q: Where the whole thing ended...  
1317
- 1318 A: Correct.  
1319
- 1320 Q: ...that location?  
1321
- 1322 A: Yeah.  
1323
- 1324 Q: Okay. Um, let's go over just a little bit again of like when you first get there,  
1325 as you're pulling up...  
1326
- 1327 A: Uh-huh.  
1328
- 1329 Q: ...what exactly do you see? What do - what is it you see?  
1330
- 1331 A: When I first pulled up I just saw the patrol cars. I didn't see anybody. I was -  
1332 was assuming they were in front of the patrol cars. Um, as I pulled into where  
1333 I parked I saw - I saw a deputy - uh, the back of a deputy, I believe, so I kinda  
1334 knew they were in towards the front of the patrol cars. As I got out of my  
1335 patrol and kinda worked my way in between the other cars they kinda came  
1336 into - onto El Camino or more into my view on El Camino. I don't know if  
1337 they were...  
1338
- 1339 Q: So they were still kind of moving a little bit at that point?  
1340
- 1341 A: They were still moving. They kinda were moving - and I don't know if they  
1342 were on the sidewalk or not but from where the sidewalk would be into the  
1343 street.  
1344
- 1345 Q: Okay. And was everybody still kind of upright at that point?  
1346
- 1347 A: Um, the deputies were. Um, he was on his back by the time I came into view  
1348 of him.  
1349
- 1350 Q: So the first time you see him...

1351  
1352 A: See him he was on his back, correct.  
1353  
1354 Q: Um, and did you see the - the fact that the Taser wires were in him...  
1355  
1356 A: Yes I saw...  
1357  
1358 Q: ...by then or within seconds of that?  
1359  
1360 A: Within seconds. I saw the wires coming out of the Taser so I assumed that it  
1361 had been deployed and that's - I only saw one prong but I saw the prong that  
1362 hit him on the hand and I don't remember what hand it was. But it had stuck  
1363 right into the flat part of your hand right by your wrist.  
1364  
1365 Q: Did you hear the - the noise from the Taser?  
1366  
1367 A: No.  
1368  
1369 Q: At any point?  
1370  
1371 A: Um, I believe it was the second activation. I heard that one.  
1372  
1373 Q: Which was the second time he went to the ground?  
1374  
1375 A: Correct.  
1376  
1377 Q: Around the time that you described drawing your ASP?  
1378  
1379 A: Correct.  
1380  
1381 Q: Uh, you drew your ASP. You deployed it as far as extending it.  
1382  
1383 A: Correct.  
1384  
1385 Q: Did you ever use it?  
1386  
1387 A: No.  
1388  
1389 Q: Did you ever use your Taser?  
1390  
1391 A: No.  
1392  
1393 Q: Did you ever use your pepper spray?  
1394  
1395 A: No.

1396  
1397 Q: And obviously you never used your firearm.  
1398  
1399 A: Correct.  
1400  
1401 Q: And there's no other weapons that you have other than personal weapons.  
1402  
1403 A: Right I have a - I also have a secondary firearm in my pouch. I didn't use  
1404 either firearm.  
1405  
1406 Q: Um, did you ever punch or strike him or...  
1407  
1408 A: No, I did not.  
1409  
1410 Q: Okay. Just tried to physically...  
1411  
1412 A: Tried to physically grab him.  
1413  
1414 Q: ...restrain him. Uh, when he's down on the ground...  
1415  
1416 A: Uh-huh.  
1417  
1418 Q: ...um, did you see that the prongs were still in him at all or...  
1419  
1420 A: I - I did not see it.  
1421  
1422 Q: Okay. Okay. Um, is there anything else that during the course of this that we  
1423 haven't talked - that I haven't asked you a question about that you think we  
1424 should know about or that you want to talk about?  
1425  
1426 A: No.  
1427  
1428 Q: Okay. Then I'm gonna turn it over to your attorney here to ask any questions  
1429 that he sees.  
1430  
1431 A1: Just a couple short ones. Based on your 23...  
1432  
1433 A: Yes.  
1434  
1435 A1: ...years of training and experience did you do anything that would fall outside  
1436 policy you've been trained in?  
1437  
1438 A: No.  
1439  
1440 A1: Okay. Did you observe any of your fellow deputies do anything like that?

1441  
1442 A: No.  
1443  
1444 A1: Um, and during the time you were there, um, Deputy Wang is actually the  
1445 victim of an assault?  
1446  
1447 A: Correct.  
1448  
1449 A1: Okay. Um, from listening to what you've said so far it seemed - well let - let  
1450 me just break it up. Um, the gentleman that we've been discussing who was  
1451 on the ground when you arrived and had at least one Taser prong that you saw  
1452 in him, um, you at some point during this incident spoke with him?  
1453  
1454 A: I - I attempted to, yes.  
1455  
1456 A1: Yes. And you were trying to calm him, right?  
1457  
1458 A: Yes.  
1459  
1460 A1: And did you hear other deputies and the sergeants speaking to him also?  
1461  
1462 A: Yes.  
1463  
1464 A1: And were they also have the objective of trying to calm him and getting him  
1465 to comply?  
1466  
1467 A: Yes.  
1468  
1469 A1: Okay. Is there anything else you want to add?  
1470  
1471 A: No.  
1472  
1473 A1: That's all I have.  
1474  
1475 Q: All right. Perfect. I guess Deputy DeMartini is here now as well so I'm gonna  
1476 reset everything here.  
1477



**Investigation:**

On October 3, 2018, I was assigned as the primary investigator for the San Mateo County District Attorney's Office investigation into an Officer Involved Critical Incident (OICI) which occurred on that date involving deputies from the San Mateo County Sheriff's Office.

On October 5, 2018, I conducted an interview with Deputy John DeMartini of the San Mateo County Sheriff's Office. Deputy DeMartini was one of five (5) deputies who were involved in a use of force incident which included the deployment of both a Taser and pepper spray. The subject of the use of force, decedent Chinedu Okobi was later pronounced deceased at Mills-Peninsula Hospital. This incident occurred in the 1400 block of El Camino Real in the City of Millbrae. The interview with Deputy DeMartini was conducted at the San Mateo County District Attorney's Office and was documented through both audio and video recording. Also present during the interview was Attorney Gregory Thoming of Mastagni Holstedt, APC. During the interview, I confirmed with Deputy DeMartini he was providing a voluntary statement to the District Attorney's Office and he had not been ordered to provide a statement by any members of the San Mateo County Sheriff's Office.

Prior to the beginning of the interview, Senior Inspector Massey met with Gregory Thoming who advised us Deputy DeMartini was requesting he be allowed to review his Mobile Audio Video (MAV) footage and any civilian video footage prior to providing a voluntary statement in this matter (see Senior Inspector Massey's supplemental report for further details). Thoming reviewed all the available MAV footage and civilian video footage at the District Attorney's Office prior to meeting with Deputy DeMartini. Thoming then reviewed Deputy DeMartini's MAV footage and the available civilian video footage at the District Attorney's Office with Deputy DeMartini prior to the interview. During the interview, I confirmed with Deputy DeMartini he had only viewed the two (2) videos prior to our interview.

**Interview with Deputy John DeMartini (paraphrased and not verbatim):**

Deputy DeMartini stated he has worked for the San Mateo County Sheriff's Office for seventeen (17) years. Deputy DeMartini began his career with the San Francisco Sheriff's Department, where he worked as a Deputy Sheriff for approximately four and a half (4.5) years. Deputy DeMartini said he had no prior law enforcement background prior to being employed by the San Francisco Sheriff's Department. Deputy DeMartini served in the United States Army for approximately four (4) years but was never deployed to any conflicts or combat situations. As a member of the San Mateo County Sheriff's Office, Deputy DeMartini stated he has been assigned to the Corrections, Transportation and Patrol Divisions over the course of his career. Deputy DeMartini said he was additionally assigned to the Civil Division at the San Francisco Sheriff's Department for a short period of time. Deputy DeMartini said he is currently assigned to the Millbrae Patrol Bureau, where he has been assigned since October of 2017. Deputy DeMartini identified his primary assigned patrol beat as being the "Eichler Highlands" which is the area near highway 92 and highway 280 in unincorporated San Mateo County.

Deputy DeMartini and I discussed the equipment he wore on his person on October 3, 2018. Deputy

**CONTROLLED DOCUMENT**

Prepared By: 80205 DRAPER, JAMIE	Date: 10/12/2018	Approved By: 80240 WARREN, JOHN	Date: 12/18/2018
-------------------------------------	---------------------	------------------------------------	---------------------





DeMartini said he was not wearing an external ballistic vest carrier and all his equipment was carried on his duty belt. Deputy DeMartini said his departmental issued firearm was in a holster on his right hip, and he carried spare magazines, a set of handcuffs and a key holder along the front of his belt. Deputy DeMartini said he carried his Taser on the left hip with his ASP (collapsible baton) and police radio to the rear of the Taser. Deputy DeMartini said he was wearing a short-sleeved standard Sheriff's Office wool police uniform with his name tag and badge affixed to the chest and Sheriff's Office patches on each shoulder. Deputy DeMartini said he does not carry a secondary firearm or any other equipment other than what he described as being on his duty belt.

Deputy DeMartini told me October 3, 2018 was an overtime shift for him and he was scheduled to work 6:00 AM to 6:00 PM. Deputy DeMartini said October 3, 2018 would have been his third (3<sup>rd</sup>) consecutive day working as October 1, 2018 and October 2, 2018 had been his regularly scheduled work days where he had worked 6:00 AM to 6:00 PM out of the Millbrae Patrol Bureau. Deputy DeMartini described his time off after his normal shift on October 2, 2018 prior to starting his shift on October 3, 2018 as uneventful. During those hours off work, Deputy DeMartini said he did not consume any alcohol and was not on any medications which would impair his abilities. Deputy DeMartini described his shifts on both October 2, 2018 and October 3, 2018 as uneventful prior to the incident which was the subject of this interview. Deputy DeMartini said he did not have any stressful calls on October 3, 2018 prior to the incident. Deputy DeMartini noted his beat in the "Eichler Highlands" is so far away from Millbrae that it does not typically make sense for him to respond to cover Deputies on calls in the Millbrae area. Deputy DeMartini did not recall going to any other calls for service on October 3, 2018 and noted the "Eichler Highlands" beat is typically a "very quiet beat".

On October 3, 2018, Deputy DeMartini said he was in Sheriff's Office vehicle #16 which is a fully marked Ford Taurus patrol vehicle. Deputy DeMartini said he sometimes drives vehicle #16 and other times he will drive Sheriff's Office vehicle #13 when it is available, because it is a marked Ford Explorer (SUV) which he finds easier to get in and out of. Deputy DeMartini stated vehicle #16 was equipped with Mobile Audio Video (MAV); however, the body-worn microphone for the vehicle was missing. Deputy DeMartini said the body-worn microphone has been missing from vehicle #16 since at least October 2017 when he was assigned to the Millbrae Patrol Bureau. Deputy DeMartini said he has mentioned it's absence to supervisors in the past, but it had not been replaced. Deputy DeMartini said his assigned supervisor for the shift on October 3, 2018 was Sergeant David Weidner and he identified his normal assigned supervisor as Sergeant Daniel Guiney.

I asked Deputy DeMartini if he received a full night's sleep prior to beginning his shift on October 3, 2018. Deputy DeMartini said he had received a full night's sleep and said he typically goes to sleep at approximately 10:30 PM and wakes up by approximately 3:30 AM on the mornings he works. Deputy DeMartini confirmed this was his sleep cycle before starting his shift on October 3, 2018. Deputy DeMartini said he reports directly to the Millbrae Patrol Bureau for each shift and typically arrives at the substation by 5:00 AM to prepare for his shift. Deputy DeMartini noted he has to come in early for his

**CONTROLLED DOCUMENT**

Prepared By: 80205 DRAPER, JAMIE	Date: 10/12/2018	Approved By: 80240 WARREN, JOHN	Date: 12/18/2018
-------------------------------------	---------------------	------------------------------------	---------------------



shift to avoid traffic during his commute. Deputy DeMartini said he was assigned as a solo Deputy for his shift as is typical of a patrol assignment at the San Mateo County Sheriff's Office.

I asked Deputy DeMartini to walk me through the incident which occurred in the 1400 block of El Camino Real on October 3, 2018. I asked Deputy DeMartini to start with the point he first became aware of the radio traffic up to the point he was relieved at the scene. Deputy DeMartini said he got to the Millbrae Police substation at approximately noon to eat his lunch. After finishing his lunch, Deputy DeMartini said he was checking Emails on a computer in the report writing room. Deputy DeMartini explained that due to the placement of his radio, the volume knob will sometimes get inadvertently turned down when he sits in arm chairs. Deputy DeMartini said he heard something being broadcast over the air but heard it from Deputy Bryan Watt's radio since his was turned down and Deputy Watt was nearby him. Deputy DeMartini asked Deputy Watt what the radio traffic was about, and Deputy Watt told him Deputy Joshua Wang was asking for an additional unit. Deputy DeMartini said he turned his radio back up, but did not respond right away because Deputy Wang's beat partner, Deputy Alyssa Lorenzatti got up and left the room to go cover Deputy Wang. Deputy DeMartini said he and Deputy Watt started to walk out to their patrol vehicles when they heard Deputy Wang then ask for "code 3 cover". Deputy DeMartini said Sergeant Weidner came out to his vehicle at this point and all three of them began to respond, "code 3" to Deputy Wang's location from the Millbrae Substation.

Deputy DeMartini said Deputy Wang put out a description of the subject which Deputy DeMartini recalled as being "a black male with bags". Deputy DeMartini said when he arrived in the area, he observed a subject walking southbound on El Camino Real and said he and Deputy Lorenzatti both exited their vehicles to attempt to contact the subject. Deputy DeMartini said they tried to talk with the subject, though he could not recall exactly what he and Deputy Lorenzatti were saying other than something similar to "can we talk to you" and "let me see your hands". Deputy DeMartini said at one point he tried to grab the subject by a wrist to try and place him in a control hold, but the subject pulled away leaving Deputy DeMartini with a "handful of his sweater". Deputy DeMartini said he was holding on to the sweater sleeve and the subject was able to pull completely out of the sweater and began to walk out into El Camino Real. Deputy DeMartini also recalled the subject had set his bags down at some point prior to going into the roadway. Deputy DeMartini said he tried again to grab the subject, but the subject pulled away from him again and then Deputy Wang deployed his Taser. Deputy DeMartini said the Taser deployment by Deputy Wang caused the subject to go to the ground, where Deputy DeMartini and the other deputies on scene began giving the subject commands to turn over on his stomach so they could handcuff him. Deputy DeMartini said the subject was not paying attention, was attempting to pull the Taser "leads" out of his body and was kicking out his legs at Deputy DeMartini and the other deputies. Deputy DeMartini recalled attempting to grasp the subject's ankles, to try and prevent the subject from kicking, but he was unable to hold on to the subject.

Deputy DeMartini said the subject was able to get back up on his feet and began to run eastbound across El Camino Real into traffic. Deputy DeMartini recalled a second Taser deployment causing the subject

**CONTROLLED DOCUMENT**

Prepared By:  
80205 DRAPER, JAMIE

Date:  
10/12/2018

Approved By:  
80240 WARREN, JOHN

Date:  
12/18/2018





to fall to the ground a second time. Deputy DeMartini said the subject was somehow able to get back up on his feet again. After the subject got to his feet, Deputy DeMartini recalled seeing Deputy Watt had brought his ASP out. He did not believe Deputy Watt ever struck the subject with the ASP. Deputy DeMartini said the subject then began to run eastbound across El Camino Real again and recalled the subject being between he and Deputy Wang. Deputy DeMartini said he saw Deputy Wang now had his ASP out as well, but because the subject was in between he and Deputy Wang, he did not see if Deputy Wang struck the subject with the ASP or not. Deputy DeMartini said he recalled thinking in his mind that if the subject were to grab the ASP from Deputy Wang, he was going to be able to get it away from Deputy Wang "because of the sheer size of the guy". Deputy DeMartini felt he needed to try and see if he could knock the subject to the ground to prevent him from trying to grab Deputy Wang's ASP. Deputy DeMartini did what he described as a "shoulder check" (tackle) which caused the subject to either trip or fall. Deputy DeMartini said this may have caused the subject to also run into Deputy Wang because Deputy DeMartini said he, the subject and Deputy Wang all fell to the ground together. Deputy DeMartini described them as being "behind the truck" on El Camino Real trying to gain control of the subject. Deputy DeMartini said he was trying to grab the subject's legs and control them, but the subject kept kicking and the other deputies were trying to get the subject's arms behind his back to place him in handcuffs. Deputy DeMartini said the subject was still fighting with them and someone (unknown to him who) deployed some pepper spray which affected some of the other deputies. Deputy DeMartini noted they now had "blind deputies trying to control the guy".

Deputy DeMartini said while he was attempting to control the subject's legs, he recalled seeing Community Service Officer (CSO) Joey Gonzales and yelling out for CSO Gonzales to go get water for the affected deputies so they could flush their eyes and "maybe be able to see at least". Deputy DeMartini said that while CSO Gonzales was retrieving the water, they were able to finally get one arm behind the subject and Deputy DeMartini was able to place one handcuff on him. They then linked a second set of handcuffs together, due to the size of the subject's shoulders, and Deputy DeMartini was able to get the second handcuff on the subject's other arm. Deputy DeMartini said once the subject was handcuffed, he and the other deputies turned the subject up onto his side, so he was facing southbound on El Camino Real and then ultimately moved him up in to a sitting position on the ground. Deputy DeMartini said Deputy Bryan Watt was standing behind the subject using his legs as a backrest to support the subject upright. Deputy DeMartini noted that Deputy Watt had been blinded by pepper spray so he relieved him and continued to support the subject upright while Deputy Watt flushed his eyes out with water. Deputy DeMartini said he continued to support the subject in an upright seated position while waiting for the arrival of paramedics, whom Deputy DeMartini said had already been summoned to the scene. Ultimately, Deputy DeMartini said he was relieved by another deputy (he was unsure which one) and was asked by Sergeant Weidner to go take photographs of the scene and get statements from possible witnesses. Deputy DeMartini said he was away from the area of the location where the subject was detained for quite a while and when he returned, medics had placed the subject on a gurney and were loading him into an ambulance.

**CONTROLLED DOCUMENT**



I asked Deputy DeMartini how the subject was acting once he was being propped up in a seated position. Deputy DeMartini said the subject was not alert, but he could hear him breathing. Deputy DeMartini said the subject had his head facing downward so he lifted the subject's head back to assist the subject in breathing better and recalled checking the subject for a pulse. Deputy DeMartini said he felt a pulse but could not be completely certain now that what he was feeling was the subject's pulse or his own since he had "just been wrestling around with the guy".

Deputy DeMartini said when he first arrived on the scene and first saw the subject, the subject was walking on the sidewalk. Deputy DeMartini did not recall ever hearing Deputy Wang broadcast a clothing description and believed only a physical description had been provided. I asked Deputy DeMartini what indicated to him the subject he observed was the same subject Deputy Wang was attempting to contact. Deputy DeMartini explained he could see Deputy Wang further north on the same side of El Camino Real and Deputy Wang had broadcast the subject was walking southbound away from him and toward the incoming units. Deputy DeMartini added his belief the subject was the only other person in the area as well. Deputy DeMartini said Deputy Alyssa Lorenzatti was the first deputy he saw attempt to contact the subject, but said he was not able to see exactly what attempt Deputy Lorenzatti made to detain the subject due to the fact the subject was between him and Deputy Lorenzatti at the time. Deputy DeMartini said he saw her attempt to grab the subject, but he could not see where on the subject she tried to grab. I asked Deputy DeMartini what the subject did in response to Deputy Lorenzatti's attempt to grab him and Deputy DeMartini said "he was pulling away from everybody". Deputy DeMartini went on to say the subject had already "thrown his bags" to the ground before they had got to him which told him, based on his own experience "somebody is getting ready to use their hands. They don't want to be incumbered" and had in his mind that the subject was possibly getting prepared to fight.

I asked Deputy DeMartini if he heard the subject say anything as they attempted to contact him. Deputy DeMartini said the subject was saying something, but he could not remember what was being said. I asked Deputy DeMartini if the subject was down on the ground face down or face up after the first Taser deployment took him to the ground. Deputy DeMartini said, "He was supine. He was face up". Deputy DeMartini recalled seeing one Taser probe in the subject's torso and one in the back of the subject's hand. Deputy DeMartini pointed to the right side of his own chest and the back of his left hand as he described the locations to me. Deputy DeMartini reiterated his belief the Taser was deployed a total of two (2) times and the second deployment was a reactivation of the Taser with the probes still attached from the first deployment. Deputy DeMartini described these two (2) activations as the two (2) times the subject fell to the ground, but added he was making an assumption the Taser was activated the second time by the reaction of the subject and him falling to the ground as he did not recall hearing the "clacking" sound of the Taser during the second perceived deployment.

I asked Deputy DeMartini to describe the physical appearance of the subject to me. Deputy DeMartini described the subject as a black male who was approximately 6'3" to 6'4" in height and weighed "in the

**CONTROLLED DOCUMENT**

Prepared By: 80205 DRAPER, JAMIE	Date: 10/12/2018	Approved By: 80240 WARREN, JOHN	Date: 12/18/2018
-------------------------------------	---------------------	------------------------------------	---------------------





CONTROLLED DOCUMENT

threes”, referring to the subject as having been over three hundred (300) pounds. Deputy DeMartini further described the subject as “a large guy”. Deputy DeMartini said when he first got up to the subject, the subject’s eyes were “wide open” and “his pupils were pretty pinned out”. I asked Deputy DeMartini if he felt the subject was possibly suffering from some sort of mental illness or if he was possibly under the influence. Deputy DeMartini stated to me “one or the other or both. I would say”. I asked Deputy DeMartini how the subject was reacting during the Taser deployment. Deputy DeMartini said the subject at first was reacting as if the Taser was effective, but when he was on the ground the subject made attempts to “pull the probes out”. Deputy DeMartini said the Taser deployment “was effective in that he...he went down, but it wasn’t effective in that, like you know ‘I didn’t like the way that felt so I’m gonna comply’ type thing” and added “he just kinda shrugged it off”. I asked Deputy DeMartini if this was consistent behavior from other Taser deployments he had seen and Deputy DeMartini said, “In the few tasings I’ve seen, no”. Deputy DeMartini went on to state normal persons, not under the influence or having mental health issues, generally will comply after having a Taser utilized on them. I asked Deputy DeMartini if he ever deployed any of his own less-lethal options during the incident and he told me he did have his Taser out at one point in time after he had taken the subject to the ground and they were trying to get him in handcuffs. Deputy DeMartini said he did not think he ever turned the Taser on and he returned it to his holster because they had the subject contained on the ground. Deputy DeMartini described the time period where he returned the Taser to the holster as being after “everyone had been pepper sprayed”. I asked Deputy DeMartini if he was affected by the pepper spray. Deputy DeMartini said Deputy Lorenzatti was in front of him and “took the brunt of it” but did describe feeling some effects of it near his left eye but said he could still see.

Deputy DeMartini said he did not believe he had ever had any contact with the subject before and did not recall ever seeing him on the streets or when he worked inside the jail, nor did he recognize him as anyone he had ever seen walking around “Millbrae proper”. I asked Deputy DeMartini if he ever saw the subject “strike” or “physically assault” any of the other involved deputies. Deputy DeMartini said “I didn’t see that. No”. Deputy DeMartini said he did observe physical injuries on Deputy Wang’s face, but said the subject was between he and Deputy Wang just before Deputy DeMartini took the subject to the ground. Deputy DeMartini said he could see the subject advancing toward Deputy Wang and demonstrated to me the subject was flailing his hands toward Deputy Wang, but he could not see past the subject to see what exactly had occurred. I asked Deputy DeMartini about any injuries he sustained, and he described abrasions on both hands, his right elbow and both knees and said he knew he sustained the injuries because of going to the ground with the subject.

I had Deputy DeMartini describe the actions of the other involved deputies once they were on the ground during the final struggle with the subject. Deputy DeMartini described the other deputies as all attempting to gain control of the subject, primarily the subject’s arms so they could place him in handcuffs. Deputy DeMartini said he did not believe the subject’s arms were underneath him on the ground but were not behind his back either. Deputy DeMartini described the subject as a “very strong guy”. Deputy DeMartini confirmed he was the one who placed the handcuffs on the subject because

Prepared By: 80205 DRAPER, JAMIE	Date: 10/12/2018	Approved By: 80240 WARREN, JOHN	Date: 12/18/2018
-------------------------------------	---------------------	------------------------------------	---------------------



**CONTROLLED DOCUMENT**

everyone else had just been pepper sprayed and he was the only one who could see. Deputy DeMartini said he did not notice if any of the taser probes were still in the subject when he placed him in handcuffs. I asked Deputy DeMartini if there was any use of other less-lethal options other than the single pepper spray deployment during the final struggle to get the subject handcuffed. Deputy DeMartini said he did not believe anything other than physical attempts to control the subject were used and said he never observed the carotid or vascular neck restraint being utilized on the subject at anytime. I asked Deputy DeMartini if the subject was yelling while they were struggling on the ground. Deputy DeMartini said the subject was still "being vocal" but he could not remember what the subject was saying.

I spoke with Deputy DeMartini regarding his training. Deputy DeMartini said he had not ever attended a course designed to aid in the recognition of subjects who are under the influence of a controlled substance but does have experience in dealing with persons who are under the influence during his career and is generally aware of the signs and symptoms of persons who are under the influence. Deputy DeMartini said he has attended Crisis Intervention Training (CIT) and said he went through the course approximately four (4) or five (5) months prior to this incident. Deputy DeMartini said he has used some of the techniques he learned in CIT effectively since attending the course. Deputy DeMartini did not believe the techniques would have been effective in this incident as the subject was so "agitated to the point where it wouldn't have sunk in. I don't think he would have listened". Deputy DeMartini said he has maintained his POST mandated perishable skills such as defensive tactics and attends update training as assigned to do so by the San Mateo County Sheriff's Office.

I asked Deputy DeMartini if he believed this was a situation where he and the other involved deputies could have "walked away" rather than attempt to detain the subject. Deputy DeMartini said he did not believe so and went on to cite the subject's demeanor, the fact the subject was an on-going danger to himself and possibly a danger to the general public given the fact the subject was walking in and out of a very high traffic area of El Camino Real at a busy time of the day. Deputy DeMartini said he was not certain as to what exactly had transpired between the subject and Deputy Wang prior to his arrival, but based upon his own observations of the subject, he felt the subject was likely a danger to himself and needed to be evaluated for a mental health or a "5150" hold. Deputy DeMartini said the subject's large size, the fact he was "very" strong and they had great difficulty in attempting to control the subject were also a concern to him as he felt that if the subject were able to get away from them, he could possibly cause injuries to the involved deputies, to himself and to members of the public.

After a short break, I spoke with Deputy DeMartini regarding his vision. Deputy DeMartini told me he wears glasses for reading only and had them on the top of his head during the incident until they were knocked off during one point in the altercation. Deputy DeMartini described the scene as well-lit due to it being mid-day and said his vision was not impaired by the effects of the pepper spray during the final portion of the struggle to get the subject handcuffed. Deputy DeMartini described the only point where his ability to view what was occurring was obscured as being when they were all upright and the subject was between he and Deputy Wang.

Prepared By:	Date:	Approved By:	Date:
80205 DRAPER, JAMIE	10/12/2018	80240 WARREN, JOHN	12/18/2018





At the culmination of my interview, I allowed Gregory Thoming to ask any questions he might have for Deputy DeMartini. Thoming asked Deputy DeMartini if, based upon his twenty-three (23) years in law enforcement, if Deputy DeMartini felt his actions, the actions of his fellow deputies, and the actions of his sergeant in this incident were appropriate. Deputy DeMartini stated his belief they were.

**DISPOSITION:**

Attach to original report.

**Disposition:**

**CONTROLLED DOCUMENT**

Prepared By:  
80205 DRAPER, JAMIE

Date:  
10/12/2018

Approved By:  
80240 WARREN, JOHN

Date:  
12/18/2018

**INTERVIEW WITH DEPUTY JOHN DEMARTINI**

**Q=Inv. Jamie Draper**

**A=Deputy John DeMartini**

**A1=Greg Thoming**

1  
2  
3  
4  
5  
6  
7  
8  
9  
10  
11  
12  
13  
14  
15  
16  
17  
18  
19  
20  
21  
22  
23  
24  
25  
26  
27  
28  
29  
30  
31  
32  
33  
34  
35  
36  
37  
38  
39  
40  
41  
42  
43  
44  
45

A: This is where they chain you up to when they're waterboarding you - on this table.

A1: (Unintelligible).

Q: Okay. Um, yeah, just before we start real quick we'll do the - kinda identifying ourselves for the record - 'cause the video - tape is rolling. So, uh, today's date is October 5th, 2018 at 12:18 pm. I'm Inspector Jamie Draper with the DA's Office.

A1: Uh, Greg Thoming with Mastagni for Deputy DeMartini this afternoon.

A: Hi, Deputy John DeMartini, San Mateo County Sheriff's Office.

Q: Um, and before we start I just wanna confirm with you that this is a situation where it's a voluntary interview. You're here voluntarily to provide us a statement and nobody from your office has ordered you to provide and statement and that you've conferred with your attorney?

A: Yes.

Q: Okay. Um, it's a little spiel I gotta give, uh, each one, but for a lot of what I'm gonna be asking - I'm gonna be referring a checklist here to make sure that I ask certain questions that we need to ask. So, there will be times where I make not be making eye contact and looking down and I don't wanna seem like I - rude - I'm just making sure that we check everything off and, you know, that even if I'm assuming eye contact - I'm not saying stop talking.

A: Yeah, mm-hm.

Q: And you can still continue to finish your thoughts and things like that. So, just so you know. Um, we're gonna start it off by asking kinda more primary background questions. Um, some general questions. For instance start with the first one is - how long have you been in law enforcement?

A: I've been in law enforcement about 23 years.

Q: Okay. And has that all been with the Sheriff's Office?

46 A: No.  
47  
48 Q: Okay. How long have you worked for the Sheriff's Office?  
49  
50 A: This is my 17th year.  
51  
52 Q: Okay. And where did you work previous to that?  
53  
54 A: San Francisco Sheriff's Office.  
55  
56 Q: Okay. And how long were you there?  
57  
58 A: Four and a half-ish.  
59  
60 Q: Okay. Any other agencies?  
61  
62 A: No.  
63  
64 Q: Okay. Um, was that all as a deputy with those agencies?  
65  
66 A: (Unintelligible).  
67  
68 Q: 'Cause...San Francisco doesn't have COs...  
69  
70 ((Crosstalk))  
71  
72 Q: Yeah, that was my thought. Okay. So you have been a deputy that entire time?  
73  
74 A: Correct.  
75  
76 Q: Um, what assignments have you worked during the course of your career?  
77  
78 A: Jail, Transportation, Patrol.  
79  
80 Q: Okay. No other specialty assignments or anything over the years?  
81  
82 A: Out in San Francisco I was in Civil for a while, yeah.  
83  
84 Q: Okay. So, evictions and things like that?  
85  
86 A: Yeah.  
87  
88 Q: Okay. And where are you currently assigned?  
89  
90 A: I'm assigned to the Millbrae Police Bureau.

91  
92 Q: Okay.  
93  
94 A: And, uh, 40 Beat.  
95  
96 Q: Yep. And how long have you been assigned there?  
97  
98 A: Since ...I got out...well I got out in July of '17 that I TDY'ed to the Jail for  
99 two months. So, technically – October of '17.  
100  
101 Q: So it's October of '17 you've been assigned to Millbrae?  
102  
103 A: Correct.  
104  
105 Q: Okay. After a brief temporary assignment to the jail. 40 Beat is that, uh, like  
106 Eichler Highlands area?  
107  
108 A: The Eichler's.  
109  
110 Q: Okay. But you respond or report to the Millbrae...  
111  
112 A: Yes.  
113  
114 Q: ...Bureau for...  
115  
116 A: We connected to Mir- to Millbrae.  
117  
118 Q: Okay.  
119  
120 A: That's my station.  
121  
122 Q: Do you have any secondary or outside employment...  
123  
124 A: No.  
125  
126 Q: ...as a law enforcement - okay. Never attend schooling or anything?  
127  
128 A: No.  
129  
130 Q: Uh, are you right handed or left handed?  
131  
132 A: Right.  
133  
134 Q: Okay.  
135

136 A: Well actually both, but, I write with my left and I do everything else with my  
137 right. So...  
138  
139 Q: S- so you're firearm is on your right?  
140  
141 A: Gun side is my right.  
142  
143 Q: Okay. That would be - your dominate hand as far as shooting and things like  
144 that?  
145  
146 A: Correct.  
147  
148 Q: Okay. Um, which kinda brings me to the next set of questions is about your  
149 equipment. Um, do you carry a - an outer vest carrier or...  
150  
151 A: No.  
152  
153 Q: Okay, so it's all in your duty belt essentially?  
154  
155 A: Correct.  
156  
157 Q: What items do you carry on your duty belt and where are they positioned?  
158  
159 A: Carry my, uh, firearm - my right hip. Um, (unintelligible) next to that -  
160 handcuffs to the left of the buckle, key holder, uh, Taser, ASP, radio.  
161  
162 Q: Yeah. And so the Taser is on your weak side - the left hand side?  
163  
164 A: Correct.  
165  
166 Q: Um, tell me about the uniform that you were wearing on the date of this  
167 incident that we're here - which is a Wednesday I think.  
168  
169 A: Uh, it was a short sleeve Sheriff's Office lightweight blue class B uniform.  
170  
171 Q: And the class B is the wool's as opposed to the BDUs?  
172  
173 A: Correct, yeah.  
174  
175 Q: Okay.  
176  
177 A: I think these one's are - technically they're half and half. I got the wool -  
178 whatever the other mix is.  
179  
180 Q: Oh, blend.

181  
182 A: Yeah.  
183  
184 Q: But it's not the BDU inform?  
185  
186 A: Correct.  
187  
188 Q: Okay. And it has full insignia's on it?  
189  
190 A: Name tag, badge - patches, yeah.  
191  
192 Q: Patches on the sleeves? Did it have anything on the back?  
193  
194 A: No, not this one.  
195  
196 Q: Okay.  
197  
198 A: Only BDUs.  
199  
200 Q: Okay. And the BDUs say Sheriff on the back?  
201  
202 A: Correct.  
203  
204 Q: Yeah. Um, on Wednesday was this your normal, uh, assigned patrol shift?  
205  
206 A: No, I was on overtime.  
207  
208 Q: You were working an overtime shift, okay. What is your - what were your  
209 hours that day?  
210  
211 A: 6:00 am to 6:00 pm.  
212  
213 Q: Okay. And had you worked the day pri - prior to this?  
214  
215 A: Yes. (Unintelligible).  
216  
217 Q: Okay. And what were you assigned to?  
218  
219 A: Uh, 40 Beat.  
220  
221 Q: So the same beat, is that correct?  
222  
223 A: Uh, actually that was 60...  
224  
225 ((Crosstalk))



226  
227 Q: Okay, but still to Millbrae - still to Patrol?  
228  
229 A: Correct.  
230  
231 Q: Um, same hours?  
232  
233 A: Correct.  
234  
235 Q: Was that an overtime shift or was it (unintelligible)...  
236  
237 A: No, that was my regular day.  
238  
239 Q: That was your regular shift? So that had been your Friday...  
240  
241 A: Correct.  
242  
243 Q: ...and - and then you were working a day of overtime.  
244  
245 A: Yep.  
246  
247 Q: Okay. How many days had you worked consecutively at that point?  
248  
249 A: Mmm, Monday - Tuesday.  
250  
251 Q: Okay.  
252  
253 A: The - the first two days of our regular shift.  
254  
255 Q: And you have rotating days off, right?  
256  
257 A: Correct.  
258  
259 Q: Okay. I just know that there's a ton of overtime being worked.  
260  
261 A: I work a lot.  
262  
263 Q: So, people are working a lot of overtime right now.  
264  
265 A: Yeah.  
266  
267 Q: So, sometimes it can be their Monday but they've worked seven - eight days  
268 straight so we gotta kinda clarify it.  
269  
270 A: Actually had a shift scheduled for yesterday too, but, it got cancelled.

271  
272 Q: Yeah. Um, when you got off your shift on Tuesday...  
273  
274 A: Mm-hm.  
275  
276 Q: ...your normal regular shift, um, uneventful? Or was there anything interesting  
277 going on outside of work?  
278  
279 A: The shift or when I got off?  
280  
281 Q: When you got off?  
282  
283 A: No - went home.  
284  
285 Q: Okay. Um, did you have anything to drink - alcohol - when you were home?  
286 No, you didn't? Um, do you take any medications or anything that would have  
287 impaired your abilities?  
288  
289 A: Nope. Nothing...  
290  
291 Q: You're not prescribed any medications? Okay. Um, the previous shift - the  
292 Tuesday shift - was that a regular shift? Was anything stressful about it? Was  
293 it just a routine shift?  
294  
295 A: Regular shift, yeah.  
296  
297 Q: Mm-kay. Now the shift of Wednesday which you started at 6:00 am?  
298  
299 A: Correct.  
300  
301 Q: Up till about 1:00 when this incident occurred - how was that shift?  
302  
303 A: Um, for me it was uneventful. I spent most of it on the 40 Beat. Some of it in  
304 the office doing some last minute report stuff.  
305  
306 Q: Any stressful calls at all?  
307  
308 A: Nope.  
309  
310 Q: Any r- responding for code three cover or anything like that?  
311  
312 A: Not prior to this one.  
313  
314 Q: Okay, that - so that was the first one. It sounds like there were a couple other  
315 calls that day...

316  
317 A: Mmm.  
318  
319 Q: ...but you were not involved in those ones?  
320  
321 A: There was a call but I was so - I was so far up on the 40 Beat it wouldn't have  
322 made any sense to go down there.  
323  
324 Q: Okay.  
325  
326 A: Yeah.  
327  
328 Q: We talked a little bit - I mean we went over most of your equipment on your  
329 belt.  
330  
331 A: Right.  
332  
333 Q: Um, do you carry any other items not on your belt. Like, a knife or...  
334  
335 A: Secondary firearm? Nothing.  
336  
337 Q: Nothing, okay. I have some questions now about your, uh, your patrol vehicle.  
338 Is it your normal assigned vehicle or...  
339  
340 A: Um, technically for the 4- for Boy 40 that is the car, but it varies. Sometimes  
341 I'll take the 13 SUV just 'cause I can get in and out of easier.  
342  
343 Q: Do you remember which vehicle number this was that day?  
344  
345 A: 16.  
346  
347 Q: 16?  
348  
349 A: It was the Taurus.  
350  
351 Q: Okay. And 13 is a...  
352  
353 A: SUV.  
354  
355 Q: SUV.  
356  
357 A: Expedition, yeah.  
358  
359 Q: Okay.  
360

361 A: But, yeah, someone else had it or something's going on with it. Probably just  
362 come back from motor pool.  
363  
364 Q: Okay. So, 13's kinda the more, uh, regular one, but...  
365  
366 A: It depends.  
367  
368 Q: Okay.  
369  
370 A: You know, usually I take the 13.  
371  
372 Q: Okay.  
373  
374 A: Yeah.  
375  
376 Q: Are both of those vehicles equipped with MAV?  
377  
378 A: Yes.  
379  
380 Q: Okay. And you were in 16 this day?  
381  
382 A: Correct.  
383  
384 Q: Um, and obviously it had MAV (unintelligible), um, does it have the - the  
385 remote microphone?  
386  
387 A: Nope.  
388  
389 Q: Oh, uh, is it supposed to and it's missing or...  
390  
391 A: It's supposed to. I - I would imagine it's been missing since I got there and it's  
392 been brought up a couple times.  
393  
394 Q: Since October?  
395  
396 A: At least - at least since then.  
397  
398 Q: Okay, but you're aware of it (unintelligible)?  
399  
400 A: Correct.  
401  
402 Q: Okay. And you've brought it up to supervisors...  
403  
404 A: Mm-hm.  
405

406 Q: ...several times?  
407  
408 A: Myself and other people.  
409  
410 Q: Okay. Who was your, uh, direct supervisor for this shift?  
411  
412 A: It was Dave Weidner.  
413  
414 Q: Is he your normal supervisor?  
415  
416 A: No.  
417  
418 Q: Okay. Who's your normal supervisor?  
419  
420 A: Dan Guiney.  
421  
422 Q: Okay. When you came off of your Tuesday shift, um, and before starting your  
423 overtime shift - 6:00 am Wednesday morning, um, did you sleep?  
424  
425 A: Yes.  
426  
427 Q: And how much time did you sleep roughly?  
428  
429 A: Uh, from - I usually go to bed around 8:30 - wake up at 3:30.  
430  
431 Q: Okay. What time do you usually get to the Millbrae substation?  
432  
433 A: Probably around 5:00.  
434  
435 Q: And that's where you direct report to, correct?  
436  
437 A: Correct.  
438  
439 Q: Okay.  
440  
441 A: I get there 5:00 am. It's only because where I live is - I gotta beat traffic.  
442  
443 Q: Okay. Bit of a commute? Um, do you normally have a partner with you or are  
444 you a solo?  
445  
446 A: We're solo.  
447  
448 Q: And that is typical of the Sheriff's Office, correct?  
449  
450 A: Correct.

451  
452 Q: You said there were no eventful calls during the Wednesday shift. Um, what  
453 type of calls did you handle at that point?  
454  
455 A: Oh my God. Like, oh, I can't think of any on Wednesday prior to this.  
456  
457 Q: The Eichler Highlands Beat is a fairly...  
458  
459 A: It's very quiet.  
460  
461 Q: Very quiet beat, yes.  
462  
463 A: Yeah.  
464  
465 Q: Okay. Especially on day shift I would assume?  
466  
467 A: Yes. I mean I might of ha- I can't remem- it was uneventful. So...  
468  
469 Q: Okay. So, nothing that would stick out in your mind?  
470  
471 A: No.  
472  
473 Q: Then - what I'm gonna do now is kind of focus on the actual incident.  
474  
475 A: Okay.  
476  
477 Q: Um, so starting at about 1:00 when this is dispatched. What I would like you  
478 to talk to me about is when you first became aware of it, what you first heard  
479 on the radio...  
480  
481 A: Okay.  
482  
483 Q: ...and walk me through the entire incident up to the point where you're kind of  
484 relieved and pulled out of it.  
485  
486 A: Okay.  
487  
488 Q: Um, and then we'll - I might interrupt you periodically to ask some questions  
489 but for the most part I'm gonna let you tell your story and I'll try to ask the  
490 questions...  
491  
492 A: Mm-hm.  
493  
494 Q: ...afterwards. But before we get into that I wanna talk about the fact that prior  
495 to coming in here you did have a chance to look at some video?



496  
497 A: Yes.  
498  
499 Q: And what videos did you watch?  
500  
501 A: I watched, uh, the video from my MAV video and I guess one of the citizen's  
502 videos.  
503  
504 Q: The cell phone video?  
505  
506 A: Right.  
507  
508 Q: Okay. Um, as we're going through the story, uh, there's gonna be some things  
509 that you remember distinctly as happening.  
510  
511 A: Mm-hm.  
512  
513 Q: And there's gonna be some things that may have been - that you didn't  
514 remember or that you just kinda saw for the first time on the video. If it's  
515 something that going from your memory - that's great. If it's something that  
516 you remember now because of the video I would like you to tell me...  
517  
518 A: Mm-hm.  
519  
520 Q: ...that's it from the video, um, as we go forward. And - and that's my only  
521 kind of question with that. So, if you can go ahead and tell me.  
522  
523 A: Yeah, I got to the Millbrae substation, oh, noonish to eat my lunch. So I sat in  
524 there and did my lunch. Um, got up, went to the report writing room, sat down  
525 at a computer - I think I was looking at emails, something innocuous, um, for  
526 a bit. Um, I mighta been looking at the TRAK fliers... s- something.  
527  
528 Q: Right.  
529  
530 A: Um, m- sometimes when I sit down in chairs my radio knob hits the armchair  
531 and gets turned down. So I heard something - not mine, 'cause it was turned  
532 down from, uh, Bryan Watt's. So I asked him, "Hey, wa- what did he just  
533 say?" It was - I guess Wang. He said, "Oh, he's asking for additional - an  
534 additional unit." So I said, okay, so, I turn my radio back up and his partner -  
535 Lorenzatti I think had already left after hearing it. And Bryan and got and we  
536 were leaving. And as were walking out we heard it upgraded to code three  
537 cover. So, we go to our cars, I see Sergeant Weidner leave and get in his car.  
538 Bryan leaves - Sergeant Weidner then me. We're code three to his location.  
539 We get to the location, um, he's putting out the description of the individual -  
540 a black male with bags. Um, get there and I see the individual walking down

541 southbound ECR. Uh, I get out - Lorenzatti gets out and go and contact him. I  
542 think we're talking, hey, s- you know, doing (unintelligible), you know, let me  
543 talk to you, what's going on. And then let me see your hands, I think was said  
544 - I can't remember. Um, at one point - I think I reached to grab him by the  
545 wrist a- and attempted to control hold - didn't work. He pulls out and I end up  
546 with a handful of his sweater. And so now I got his sweater sleeve and he  
547 comes out of the sweater and starts g- walking out on ECR. So I put the  
548 sweater down. M- he's also throwing his bags down - his duffel bags. And,  
549 uh, tried to gain control again. He's just - tore away at some point. Um,  
550 Deputy Wang deployed his Taser. The individual goes to the ground. Um,  
551 trying to give more, i- commands to turn over so we can cuff him. He's not  
552 paying attention, he's trying to pull his - the leads out, um, kicking. So at one  
553 point I try to kinda grab his ankles to keep him from kicking everybody. But, I  
554 wasn't able to. He gets up again and starts running into - into where traffic  
555 was on ECR eastbound I believe. Um, I think he gets another tase and he goes  
556 down again. At some point he gets back up. Um, I think Bryan had his ASP  
557 out. Um, I don't think he s- hit him with hit. I can't remember. He starts  
558 running eastbound across ECR again. And from my recollection I think at that  
559 point Wang is in - kinda in front of him. It's the suspect and then me and  
560 Wang had his ASP out. I didn't see him take a swing or anything.  
561 (Unintelligible) between - he was between me and him. And at some point, in  
562 my mind I was thinking if this guy grabs that ASP from Wang he's gonna get  
563 it. You know, 'cause the sheer size of the guy. So, I said he needs - I need to  
564 see if I could knock him to the ground. So I did. I kinda shoulder checked him  
565 and, uh, either he tripped or fell and I think it - I'm not sure but I think at the  
566 same time he ran into Wang and he fell - then I fell - that's where I got all  
567 these...

568  
569 Q: Okay.

570  
571 A: Um, then his - that's - he was - moved behind the truck - middle of ECR  
572 trying to control - I was trying to control his legs 'cause he was still kicking.  
573 And everyone else was trying to get his hands out from underneath him  
574 behind his back to cuff him. He was still fighting with us. Um, at some point  
575 someone deployed some pepper spray. I'm not sure who it was. But, other  
576 deputies got affected. So now we have blind deputies trying to control the  
577 guy. And, so, I was still controlling his legs and I told, um, I think it was the  
578 SRO - Joey.

579  
580 Q: Okay.

581  
582 A: I said, Hey, go get some water in that - there's a restaurant, go get some  
583 bottles of water for these guys so they can flush their eyes out so they could  
584 maybe see at least. So, he goes off - does it. As he gone I think we finally get  
585 one arm out free and I put one cuff on - linked it with another set of cuffs

586 'cause of his size and cuffed it with the other arm. He comes back with the  
587 water. They were s- dousing their eyes. We turn him on his side. So now he's  
588 facing southbound...

589

590 Q: Okay.

591

592 A: ...with his face. And, uh, then we put him in a sitting position. Everyone was  
593 still washing out their stuff and Bryan is blinded with the pepper spray, he has  
594 got his - his leg behind his back to prop him as he's sitting up.

595

596 Q: The subject?

597

598 A: Correct. I, uh, at some point I went over to relieve Bryan so he could wash his  
599 eyes out, so, I'm holding him. Um, at that point, I - I think prior to that medics  
600 were called. They were - I heard 'em incoming - the sirens. Um, and someone  
601 else - I can't remember who - took over for me and I was told to go get  
602 statements and look for video cameras and whatnot. So I was away from that  
603 particular scene for quite a while.

604

605 Q: Okay.

606

607 A: And then by the time I came back to the scene medics where there and they're  
608 putting him on a gurney, he was going.

609

610 Q: Okay. At the point when he was, um, being propped up by you, or, well...

611

612 A: Mm-hm.

613

614 Q: ...first Deputy Watt...

615

616 A: Mm-hm.

617

618 Q: ...and then - then you - how was he acting at that point? Was he awake - was  
619 he alert - was he...

620

621 A: He wasn't alert. Um, I could hear him breathing. Um, at one point I think - so  
622 I could help him breathe better I - I kinda raised his head up a little bit. 'Cause  
623 he was down this way so his chin was kinda like this. So I raised his head up  
624 and I'm - I'm assuming he was breathing. I tried checking his carotid and I  
625 was getting a pulse. I can't be honest and say it was - I don't know if it was  
626 his I was feeling or mine - 'cause I was just wrestling around with the guy.  
627 But it was something going on there.

628

629 Q: Mm-kay.

630

631 A: So, that's pretty much it.  
632  
633 Q: Mm-kay. When you - you talked about first kinda getting there and you saw  
634 him walking southbound...  
635  
636 A: Correct.  
637  
638 Q: ...on ECR. Where was he?  
639  
640 A: Mmm.  
641  
642 Q: You know, in the roadway or...  
643  
644 A: No, he was on the sidewalk at that point, yeah.  
645  
646 Q: He was on the sidewalk, okay. Um, and did you see, like, the clothing he was  
647 wearing and everything...  
648  
649 A: Yeah.  
650  
651 Q: ...at that point? Uh, had you heard a clothing description from Officer Wang  
652 when you were responding or just a physical description?  
653  
654 A: I think it was just a physical - I can't be a - I can't be sure though.  
655  
656 Q: Mm-hm. How did you know that this was the - the person? I mean what told  
657 you that this was the guy...  
658  
659 A: Well he was - Wang was - it was - Wang was up further north m- on Santa  
660 Helana making a turn. He was telling us, oh, that's - he's walking southbound  
661 down ECR. He was the only one...  
662  
663 Q: Over his radio he was...  
664  
665 A: ...I think he was the only one there.  
666  
667 Q: Over his ra- radio he was...  
668  
669 A: Correct.  
670  
671 Q: ...telling you this? Okay. Uh, who was the first person to try and make contact  
672 with him when you were there? Was it - was it you - was it Lorenzatti?  
673  
674 A: I think it was Lorenzatti.  
675

676 Q: Okay.  
677  
678 A: Yeah.  
679  
680 Q: Did you see her try to detain him or...  
681  
682 A: I did. Uh, not - he - she was on the other side - the opposite side from me.  
683 But...  
684  
685 Q: Okay.  
686  
687 A: ...yeah, I think she - I - I didn't see exactly how she did it, but, yeah.  
688  
689 Q: But she did make some attempt...  
690  
691 A: Yeah.  
692  
693 Q: ...to - to grab him or...  
694  
695 A: Correct.  
696  
697 Q: Um, did you see where she was trying to grab?  
698  
699 A: No.  
700  
701 Q: Okay. What did you see him do?  
702  
703 A: Uh, he was pulling away from everybody. And he'd already thrown his bags  
704 down - even - before we even got to him.  
705  
706 Q: Mm-kay.  
707  
708 A: Um, which in my experience means someone's getting ready to use their  
709 hands. You know, they don't wanna be encumbered.  
710  
711 Q: Yep.  
712  
713 A: Um, so that was also in my head.  
714  
715 Q: Possibly like to fight?  
716  
717 A: Correct.  
718  
719 Q: Okay. Um, was he saying anything?  
720

721 A: I can't remember. He was saying something but I can't remember what he was  
722 saying.  
723  
724 Q: Okay. Was it that you just can't recall what he said or was it not something  
725 that you could understand?  
726  
727 A: I can't recall.  
728  
729 Q: Okay.  
730  
731 A: Yeah.  
732  
733 Q: Um, you talked about once he's on the ground the first time where the Taser  
734 has been deployed and he's...  
735  
736 A: Correct.  
737  
738 Q: ...down on the ground. Was he face down - face up?  
739  
740 A: Oh, he was supine, he was face up.  
741  
742 Q: Okay. And that's when you guys were trying to...  
743  
744 A: Get control...  
745  
746 Q: ...get a hold of him and (unintelligible).  
747  
748 A: Correct.  
749  
750 Q: Could you see at that point that the probes were in him?  
751  
752 A: Yeah, I saw there was one - I (unintelligible) I'm not sure if there's one is in  
753 his - his torso - I'm pretty sure. I know one was in his hand.  
754  
755 Q: Okay. Like the back of his hand?  
756  
757 A: 'Cause I saw one in the back of his hand.  
758  
759 Q: Okay.  
760  
761 A: Wh- which, yeah, uh, that made a good connection or not. But...  
762  
763 Q: Um, I think you described two time where you saw the Taser used or  
764 activated?  
765



766 A: Correct. But in this time and I think he - with the probe still in he - he was  
767 tased. He just reactivated the trigger.  
768  
769 Q: And that's when he had gotten back up?  
770  
771 A: Up originally. Started running into traffic and then went back down.  
772  
773 Q: So he was up and down twice...  
774  
775 A: Right.  
776  
777 Q: ...at that point and then - then...  
778  
779 A: And - and - and that's just my assumption. I don't think I heard the clacking  
780 of the Taser. But, I mean his legs locked up and he just went over. So...  
781  
782 Q: Okay, so the way he fell...  
783  
784 A: Correct.  
785  
786 Q: Okay. Um, what can you tell me about the physical description of this guy?  
787  
788 A: Oh, black male, I'm gonna say 6'3" - 6'4" ish. Um, probably in the 3s, yeah.  
789  
790 Q: So - so a very big guy.  
791  
792 A: Yeah. He was a large guy. Um, when I got out of the - when I got - initially  
793 got to him and was looking at him in the face, um, his eyes were wide open  
794 and it looked like his pupils were pretty pinned out. So, that's not average  
795 looking sort of eyes.  
796  
797 Q: Okay. Do you feel like he was possibly suffering some mental illness or under  
798 the influence or...  
799  
800 A: One or the other or both. I - I would say.  
801  
802 Q: Yeah. How was he reacting to the Taser deployment? Was he acting like it  
803 was working or...  
804  
805 A: At first he did and then like I said when he was on the ground he was trying to  
806 pull the probes out. So...  
807  
808 Q: Mm-kay. And...  
809  
810 A: It was effective in that he - he went down. But, it wasn't effective in that, you

811 know, I didn't like the way that felt, so I'm gonna comply kinda thing.  
812  
813 Q: Okay.  
814  
815 A: He just kinda shrugged it off.  
816  
817 Q: Okay. Is that something that you are - have typically seen?  
818  
819 A: Um, in the few tasings I've seen - no, generally when they get tased first -  
820 depending on what's - the mental or, you know, anything else on board is  
821 considered - but, just normal average people - generally they're gonna comply  
822 after being tased.  
823  
824 Q: Mm-kay. Um, did at any point - did you ever bring out any of your other less  
825 lethal weapons?  
826  
827 A: Yeah, when we were originally over at - at the, uh, by the truck when he  
828 finally went down - I had my Taser out but I re- re-holstered it.  
829  
830 Q: Okay. So you never deployed it...  
831  
832 A: I never - yeah deployed it. I don't think I ever turned it on.  
833  
834 Q: Okay. And why'd you put it away?  
835  
836 A: Because there - we had him under control and it was sufficient - at that point.  
837  
838 Q: Yeah. Was he cuffed at that point or just you had him...  
839  
840 A: I th- not - not yet - he wasn't cuffed yet. But...  
841  
842 Q: But people were on top of him.  
843  
844 A: Right, everyone had just been pepper sprayed, so...  
845  
846 Q: Okay. So, you had it out at that point...  
847  
848 A: Yeah.  
849  
850 Q: ...that the pepper spray was deployed?  
851  
852 A: Right.  
853  
854 Q: Okay. And did the pepper spray affect you or...  
855

856 A: Very minor. I had ...Lorenzatti was higher than me...I think she took the  
857 brunt of it. I got a little bit just on the side of my eye. But...  
858

859 Q: Okay.

860

861 A: ...I could still see.

862

863 Q: Had you ever seen this guy before?

864

865 A: I don't think so.

866

867 Q: Okay.

868

869 A: I don't think so.

870

871 Q: So, no prior interactions with him?

872

873 A: Not with me, no.

874

875 Q: Okay. Um, and your pre- pretty familiar with that Millbrae area and the  
876 location?  
877

878 A: I had been there for a while, but it's (unintelligible)...

879

880 Q: Okay.

881

882 A: ...I would imagine - I haven't seen him in the jail and I worked the jail. I don't  
883 recognize him. I recognize him from Millbrae proper walking around.  
884

885 Q: Okay. And I think that - I think from what you said the only time you saw the  
886 paramedics treating him was - as they were already...  
887

888 A: Correct.

889

890 Q: ...leaving with him or getting ready to leave with him.

891

892 A: Right. They showed up and I went to go do my - what I was told to do.

893

894 Q: Okay.

895

896 A: So I was off scene.

897

898 Q: At the point that you left that area he was still sitting upright?

899

900 A: Correct.

901  
902 Q: And still breathing to the best of your knowledge?  
903  
904 A: I don't - I would imagine so - I don't know.  
905  
906 Q: To the best of your knowledge he was?  
907  
908 A: Yeah.  
909  
910 Q: The last time you had checked?  
911  
912 A: Yes.  
913  
914 Q: Okay. Um, you talked about the, uh, the CSO that was there...  
915  
916 A: Mm-hm.  
917  
918 Q: ...Joey Gonzales.  
919  
920 A: Mm-hm.  
921  
922 Q: Uh, did he get involved in trying to help you guys detain this guy?  
923  
924 A: I don't think so.  
925  
926 Q: He was there pretty early on though - is his truck was...  
927  
928 A: Mm-hm.  
929  
930 Q: ...parked there. Did you ever see, um, this guy strike any of the other deputies  
931 or physically assault any of them?  
932  
933 A: I didn't see that, no.  
934  
935 Q: Okay.  
936  
937 A: Like I say, the only one I know that any kind of injuries was Wang. But I  
938 (unintelligible)...  
939  
940 Q: So you saw some physical injuries on him?  
941  
942 A: Afterwards. 'Cause Wang was - he was between me and Wang so he was  
943 kinda taking up the space I couldn't really see around him.  
944  
945 Q: Okay. And so you couldn't see around...

946  
947 A: I know he was going after him. There was hands and things. So, which is why  
948 I thought, God, don't let him get this ASP out of Wang's hands, you know.  
949  
950 Q: And this is about the point that you...  
951  
952 A: Yes.  
953  
954 Q: ...took him to the ground?  
955  
956 A: Yes.  
957  
958 Q: Okay.  
959  
960 A: At least I think it was me. I don't know. I know I - I ran into him. But...  
961  
962 Q: Okay. Was there ever an opportunity where you or any of the other officers  
963 were able to identify yourself as police officers to him?  
964  
965 A: Verbally?  
966  
967 Q: Yes.  
968  
969 A: Uh, I don't remember. I mean ...rolled up in marked police cars in full  
970 uniform, so...  
971  
972 Q: And was the emergency equipment...  
973  
974 A: Oh, yeah.  
975  
976 Q: ...on on the vehicles?  
977  
978 A: Oh, yeah.  
979  
980 Q: And functioning properly?  
981  
982 A: Yeah. Yeah, MAV doesn't come on unless you hit the lights, so.  
983  
984 Q: Okay. And you have some scrapes and scrapes and abrasions that you talked  
985 to...  
986  
987 A: (Unintelligible) here, elbow and knees, Mm-hm.  
988  
989 Q: And you believe those happened kinda at the end point when he went to the  
990 ground?

991  
992 A: Oh, I know that's when it happened.  
993  
994 Q: Okay. When you went to the ground with him?  
995  
996 A: Correct.  
997  
998 Q: Or kinda during the struggle?  
999  
1000 A: When I went to the ground with him.  
1001  
1002 A1: Okay. And just so the record's clear - when you said here are you talking  
1003 about your hand?  
1004  
1005 A: Uh, this one - this...  
1006  
1007 Q: It looks like the forearm.  
1008  
1009 A: Yeah, and through here.  
1010  
1011 A1: Okay.  
1012  
1013 A: And my knees.  
1014  
1015 Q: Yep. Did that cause any damage to your uniform?  
1016  
1017 A: Yeah.  
1018  
1019 Q: Um, what happened to your uniform then?  
1020  
1021 A: Uh, my knee and my right knee got a scuff. I don't think all - went all the way  
1022 through.  
1023  
1024 Q: Okay.  
1025  
1026 A: 'Cause looks like it's about ready to.  
1027  
1028 Q: Okay.  
1029  
1030 A: Huh.  
1031  
1032 Q: When he was on the ground. Once he had gone to the ground - whether you  
1033 took him to the ground or somebody else did. Um, what was everybody else  
1034 doing? You talked about holding his legs...  
1035

1036 A: Yeah.  
1037  
1038 Q: ...for the most part.  
1039  
1040 A: Uh, I think - I think most people were just trying to hold him in place from  
1041 flaying and kicking and trying to get up again. You know, accompanied with  
1042 trying to get his arm out so we could place handcuffs on him.  
1043  
1044 Q: So did he have his arms underneath his body or...  
1045  
1046 A: I can't remember. I - I don't - I don't think so. I think he's just a strong guy.  
1047 And we couldn't...  
1048  
1049 Q: They weren't behind him though?  
1050  
1051 A: I don't think so.  
1052  
1053 Q: Okay. And you describe putting the handcuffs on and s- was it you that put the  
1054 handcuffs on him?  
1055  
1056 A: Yes, 'cause everyone else had just been pepper sprayed.  
1057  
1058 Q: Okay.  
1059  
1060 A: So I was the only one who could see.  
1061  
1062 Q: Okay. Uh...  
1063  
1064 A: So they had one set on and then I got my set out and double linked it and then  
1065 someone was able to get his other arm up and I think it was only one click.  
1066  
1067 Q: Oh...  
1068  
1069 A: So, not sure.  
1070  
1071 Q: Okay. Um, were the t- were you able to see if any of the Taser prongs were  
1072 still in at that point?  
1073  
1074 A: I didn't get - notice.  
1075  
1076 Q: Okay. Like his hand one?  
1077  
1078 A: I didn't notice.  
1079  
1080 Q: Okay. Other than the pepper spray being deployed down on the ground - was



1081                   there any other deployment of anything - either Taser or ASP...  
1082  
1083    A:                I don't think so.  
1084  
1085    Q:                ...carotid restraint or anything.  
1086  
1087    A:                I think it was just the pepper spray - there wasn't carotid at all.  
1088  
1089    Q:                Okay. You didn't see anybody put...  
1090  
1091    A:                I didn't see anything, yeah.  
1092  
1093    Q:                And certainly, you were at his legs, so...  
1094  
1095    A:                Correct.  
1096  
1097    Q:                Okay. Was he still yelling at this point or was he kind of quiet at this point?  
1098  
1099    A:                Can't remember. He was being vocal but I don't know what he was saying.  
1100  
1101    Q:                Yeah. So he was making some...  
1102  
1103    A:                Yes.  
1104  
1105    Q:                ...some sort of noises? During your career obviously had to take a lot of  
1106                    training classes...  
1107  
1108    A:                Hm.  
1109  
1110    Q:                ...and things like that. So I wanna talk to a little bit about some of those ones  
1111                    that you've taken. Have you taken any classes to recognize persons under the  
1112                    influence - like a DRE class or 11550?  
1113  
1114    A:                I haven't taken 11-5 or DRE.  
1115  
1116    Q:                Okay. You've worked in a custodial setting quite a bit...  
1117  
1118    A:                Yeah.  
1119  
1120    Q:                ...and on the streets.  
1121  
1122    A:                Yeah.  
1123  
1124    Q:                Do you have experience dealing with persons who are under the influence?  
1125

1126 A: Yes.  
1127  
1128 Q: Okay. And you're familiar with the signs and symptoms of somebody who is  
1129 under the influence?  
1130  
1131 A: Uh, gen- in general, yes.  
1132  
1133 Q: Okay. Not to do an evaluation of them but...  
1134  
1135 A: Correct.  
1136  
1137 Q: ...enough to make a perception?  
1138  
1139 A: Correct.  
1140  
1141 Q: Okay. Um, have you had any training in CIT?  
1142  
1143 A: Yes.  
1144  
1145 Q: Okay. How long ago was that if you remember?  
1146  
1147 A: Oh, four or five months ago.  
1148  
1149 Q: Oh, so very recently.  
1150  
1151 A: Yeah.  
1152  
1153 Q: Okay. And is it something that you've been able to use so far in your daily  
1154 patrol activities?  
1155  
1156 A: Um, yeah.  
1157  
1158 Q: Some of the techniques?  
1159  
1160 A: Yeah.  
1161  
1162 Q: And have you found them to be effective where you've effectively used them?  
1163  
1164 A: Uh, yeah.  
1165  
1166 Q: Mm-kay. Do you feel they could have been employed in this circumstance?  
1167  
1168 A: Probably not.  
1169  
1170 Q: And how come?

1171  
1172 A: Uh, I think that he was (unintelligible) - I don't think it would have been  
1173 effective. I mean he was very, uh, I don't know what the right word to use -  
1174 um, agitated?... to the point where I don't think he would of - it wouldn't have  
1175 sunk in. Yeah, I don't think it would - he would of listened.  
1176  
1177 Q: Okay. Um, you've had defensive tactics or...  
1178  
1179 A: Mm-hm.  
1180  
1181 Q: ...arrest and control technique...  
1182  
1183 A: Yes.  
1184  
1185 Q: ...training? And how often do you do that?  
1186  
1187 A: Uh, whenever the Sheriff's Office - whenever they're scheduled I think it's  
1188 twice a year.  
1189  
1190 Q: Twice a year?  
1191  
1192 A: Tw- I think so.  
1193  
1194 Q: Okay. Um, tactical communications or verbal judo...  
1195  
1196 A: Right.  
1197  
1198 Q: ...training over the years as well?  
1199  
1200 A: I haven't had that in quite a while, but I've had it.  
1201  
1202 Q: There's a video I think that they make you watch...  
1203  
1204 A: Yeah.  
1205  
1206 Q: ...periodic - have you had that?  
1207  
1208 A: Probably.  
1209  
1210 Q: Okay. Any training in first aid or anything like that?  
1211  
1212 A: Yes.  
1213  
1214 Q: Just your standard law enforcement first aid or any additional training?  
1215

1216 A: Just standard law enforcement.  
1217  
1218 Q: Okay, so no special paramedic classed or tactical medical...  
1219  
1220 A: No.  
1221  
1222 Q: ...or anything like that. Okay. Um, to carry the Taser you have to go through  
1223 some training.  
1224  
1225 A: Correct.  
1226  
1227 Q: Um, I assume you've been through that training. Um, did y- have you ever felt  
1228 the effects of the Taser?  
1229  
1230 A: No.  
1231  
1232 Q: Okay. So you were not in one of those classes where they made you get tased?  
1233  
1234 A: No. They stopped that.  
1235  
1236 Q: Yes. Unfortunately I was in one of those classes.  
1237  
1238 A: No.  
1239  
1240 Q: Um, prior to law enforcement did you have any military experience or  
1241 anything?  
1242  
1243 A: Yes.  
1244  
1245 Q: Okay. How long were you in the military?  
1246  
1247 A: Four years.  
1248  
1249 Q: Okay. Any combat experience?  
1250  
1251 A: No.  
1252  
1253 Q: Okay. So no situations where lethal force or anything like that would have  
1254 been used? What branch of the military were you in?  
1255  
1256 A: Army.  
1257  
1258 Q: Okay. Any other kinda quasi-law enforcement related employment, like,  
1259 security guard or loss prevention or...  
1260

1261 A: Mm-mm.  
1262  
1263 Q: ...anything like that? Okay. So military then straight into San Francisco  
1264 Sheriff's?  
1265  
1266 A: Well I worked for Walgreens for a while, but...  
1267  
1268 Q: Okay. As like a cashier or...  
1269  
1270 A: Yeah.  
1271  
1272 Q: Okay. When you were first getting on scene and seeing this guy walk  
1273 southbound on El Camino, um, it sounds like you and Lorrenzatti got there  
1274 pretty close to the same time...  
1275  
1276 A: Mm-hm.  
1277  
1278 Q: ...from what you're describing to me. Uh, what were you guys trying to do  
1279 with him?  
1280  
1281 A: Trying to...  
1282  
1283 Q: What was your goal?  
1284  
1285 A: ...to detain him.  
1286  
1287 Q: Okay. And why?  
1288  
1289 A: Because he was the subject of, uh, Deputy Chan calling for a code three cover.  
1290 So...  
1291  
1292 Q: Mm-kay. And you already talked a little bit about why you knew that he was  
1293 the person.  
1294  
1295 A: Right.  
1296  
1297 Q: Uh, would this have been a situation you think you could of just walked  
1298 away?  
1299  
1300 A: I don't think so.  
1301  
1302 Q: And how come?  
1303  
1304 A: Um I think based on his demeanor at the time he would probably been an  
1305 ongoing danger to himself number 1 and possibly also the public at large.

1306 Given the fact he was walking in and out of the traffic on El Camino Real at 1  
1307 o'clock in the afternoon. So...

1308  
1309 Q: A high traffic area.

1310  
1311 A: Very.

1312  
1313 Q: And that's from the very first encounter - you didn't feel...

1314  
1315 A: Correct.

1316  
1317 Q: ...it was a situation that you could back away.

1318  
1319 A: Correct.

1320  
1321 Q: And as it progressed, um, did you still feel that - that he needed to be  
1322 detained?

1323  
1324 A: Yes.

1325  
1326 Q: Okay. And how come?

1327  
1328 A: Uh, well, my initial thought was because I felt, like I said, he was a danger to  
1329 himself - other people and probably should be evaluated for 5150. Um, I  
1330 wasn't quite sure what happened between him and Wang earlier in the call  
1331 'cause I wasn't there.

1332  
1333 Q: Right.

1334  
1335 A: So, it was just pretty much that whole conglomeration of situations.

1336  
1337 Q: Okay. Did you have any concerns in regards to his size while you guys were  
1338 trying detain him?

1339  
1340 A: Absolutely. That was one of the first things that crossed my mind when I  
1341 rolled on scene was his size.

1342  
1343 Q: One of the first observations you noted to...

1344  
1345 A: Absolutely.

1346  
1347 Q: Okay. Um, in addition to the size was he also strong?

1348  
1349 A: Very strong.

1350

1351 Q: Somebody that you had difficulty getting control of?  
1352  
1353 A: Absolutely.  
1354  
1355 Q: Okay. Uh, what did you fear would happen if you couldn't get control of him?  
1356  
1357 A: Um, that people were gonna get injured - us and possibly him.  
1358  
1359 Q: Okay. I think we'll use this time to take the break for a few minutes.  
1360  
1361 A: Okay.  
1362  
1363 Q: You can confer with him for a few seconds...  
1364  
1365 A: Sure.  
1366  
1367 Q: ...out of here while I keep the video rolling and I'll confer with my, uh,  
1368 supervisors and then we'll probably come back in here for a few more just  
1369 kinda clean up questions.  
1370  
1371 A: Okay. Oh, my goodness.  
1372  
1373 Q: Again you can just go out that door.  
1374  
1375 A: Okay, yeah.  
1376  
1377 A: Leave this door?  
1378  
1379 Q: I'm gonna close this one...  
1380  
1381 A: Oh.  
1382  
1383 Q: ...yeah. (Unintelligible).  
1384  
1385 ((Crosstalk))  
1386  
1387 A: Sorry.  
1388  
1389 A1: No - no worries.  
1390  
1391 Q: Okay. So, really from my checklist the only questions that I really didn't ask  
1392 which actually should have been obvious with glasses on and on your head is  
1393 about your vision. So obviously you do wear corrective lenses.  
1394  
1395 A: Uh, yeah. For reading mostly.



1396  
1397 Q: For reading mostly.  
1398  
1399 A: Yeah.  
1400  
1401 Q: Um, did you have those on your head during the incident or was it sunglasses?  
1402  
1403 A: I had these on, uh, momentarily until they went flying.  
1404  
1405 Q: Right, I - I actually saw you pick 'em up...  
1406  
1407 A: Yeah.  
1408  
1409 Q: ...and put them back on in the video. I wasn't...  
1410  
1411 A: (Unintelligible).  
1412  
1413 Q: ...sure if it was glasses or...  
1414  
1415 A: Yeah.  
1416  
1417 Q: Okay. Um, the lighting conditions at the time out there?  
1418  
1419 A: Daylight - overcast m- I think - I think it was overcast.  
1420  
1421 Q: Okay. But, pretty clear?  
1422  
1423 A: Yeah.  
1424  
1425 Q: And anything that was obstructing your vision or anything at any time during  
1426 this?  
1427  
1428 A: Um, no I didn't get any of the pepper spray. So, (unintelligible).  
1429  
1430 Q: And nothing was in between you and th...  
1431  
1432 A: And who?  
1433  
1434 Q: ...the action? So to speak...  
1435  
1436 A: Um, no.  
1437  
1438 Q: The activities that were going on?  
1439  
1440 A: No.

1441  
1442 Q: Okay. So you had a clear view of everything that was going on?  
1443  
1444 A: Pretty clear, except for the times where he was in front of me and Wang it was  
1445 kinda...  
1446  
1447 Q: So then you couldn't see what Wang was...  
1448  
1449 A: Couldn't see him.  
1450  
1451 Q: Okay. Okay, well that's the only questions I have. So why don't I turn it over  
1452 to him.  
1453  
1454 A1: Just a couple, um, Deputy based on your 23 years of law enforcement  
1455 experience and your training - your actions on the date of this incident were  
1456 appropriate?  
1457  
1458 A: Yes.  
1459  
1460 A1: And the actions you observed of your fellow deputies and sergeant were  
1461 appropriate?  
1462  
1463 A: Yes.  
1464  
1465 A1: That's all I have.  
1466  
1467 Q: Okay. So unless there's anything else that you can think that you didn't  
1468 mention that I didn't ask?  
1469  
1470 A: Nope.  
1471  
1472 Q: Okay. Well I think we're good.  
1473  
1474 A: Okay.  
1475  
1476 Q: Just step on out of here and I'll stop the equipment.  
1477



**Investigation:**

On October 4<sup>th</sup>, 2018, at 1:30 PM, I interviewed SMCSO Deputy Joshua Wang in the interview room of the San Mateo County District Attorney's Office. The interview was recorded to a DVD. Present in the room was also Deputy Wang's legal counsel, Attorney Zeb Davis, of Mastagni Holstedt. The following is a summary of my interview of Deputy Wang:

Wang began the interview by confirming this was a voluntary interview, of his own free will, and that he had not been ordered to participate in the interview.

I then asked Wang some background questions and he responded in summary as follows:

Wang is a Deputy with the San Mateo County Sheriff's Office, assigned badge #1100, and has been employed there since February of 2018, assigned solely to Patrol. Prior to that he was employed as a peace officer by the San Francisco Police Department for a little over 4 years. His only other related law enforcement experience prior to SFPD was as a non-sworn, police volunteer for the San Carlos Police Department, assisting with tasks such as marking abandoned vehicles and parking enforcement.

Wang worked later in the Patrol Division for SFPD, assigned to the Specialist Team which is a unit that responds to critical incidents in progress, assists SWAT with high risk search warrants, and as a security detail for various gatherings and protests. He has no significant background in martial arts or combat sports and no military experience. He is right handed, using his right hand for most tasks on a daily basis.

I asked Wang to describe his attire on October 3, 2018, the date of the incident in question. He said he was wearing a long-sleeve, wool uniform shirt, with SMCSO patches on both shoulders, metal badge, metal nametag, leather "duty belt", long wool uniform pants and black "Danner" boots. His radio microphone was clipped to the front of his shirt and he had the audio microphone for his vehicle MAV (Mobile Audio Video) clipped to his right shoulder. He was wearing his firearm and holster on the right hip of his duty belt, which was also equipped with a keychain clip, OC "pepper" spray, two pair of handcuffs, his patrol radio, a collapsible baton, 2 additional firearm magazines, and his Taser X26, which was holstered to his left hip for a "non-dominant hand draw".

Wang explained that he was on-duty on October 3, 2018, working from 6:00 AM to 6:00 PM, which is his normal shift. He worked an overtime shift on October 2, 2018, at the Millbrae sub-station, working the same shift hours, which he identified as "Team 2". He told me nothing "high stress" or out of the ordinary occurred during the overtime shift. He said he slept about 6 hours the night prior to the incident in question. He did not consume any alcohol on October 3, 2018, prior to his shift. He does not currently take any prescription medication.

On October 3, 2018, Wang got dressed in his uniform at about 5:30 AM and attended morning briefing where they discussed patrol issues within the City of Millbrae. He said he felt "fine" at the start of the

**CONTROLLED DOCUMENT**

Prepared By: 80251 DECKER, RICK	Date: 10/12/2018	Approved By: 80240 WARREN, JOHN	Date: 12/17/2018
------------------------------------	---------------------	------------------------------------	---------------------



shift and was looking forward to vacationing with his wife in the near future.

I then asked Deputy Wang to provide me a complete, uninterrupted account of the incident itself, inviting him to speak at his own pace, with the intention of describing the events as they transpired in chronological order. I also invited his counsel to interrupt at any time if need be as he explained what occurred from beginning to end. The following is a summary of that account:

Wang was driving SMCSO marked patrol vehicle #10, which is a Ford, Explorer, traveling southbound on El Camino Real in Millbrae, approaching the intersection with Millwood Drive. He observed a male walking eastbound on Millwood, across El Camino Real, crossing 3 lanes of traffic "walking in the intersection when he was not permitted to do so." Wang explained he knew this because he could see that the northbound facing traffic signal for southbound traffic was green. The male then stepped up onto the center median of the roadway. Wang said he decided to make a "traffic enforcement stop and contact him."

Wang activated his emergency overhead lights and made a U-Turn, pulling alongside the male who was now walking northbound. He described the male as an "African American male, large in stature, carrying numerous bags." Wang rolled his driver's side window down and told the male, "Something along the lines of, 'Hey I need to talk to you' or 'Hey, stop, hold on.'" The male ignored Wang and continued to walk northbound along El Camino Real. Wang then accelerated past the male, stopped and tried to exit his vehicle to contact the male on foot. He said the male was now walking within the actual roadway, creating a hazard for oncoming traffic. He told me, "I was bound to this subject now...he's walking in traffic. He may get struck by a vehicle or cause an accident."

Wang then notified SMCSO Communications that he was trying to stop a pedestrian within the roadway and needed assistance, believing he would need additional assistance to safely contact the male in the busy roadway, given the high volume of traffic at that time. He said the male continued northbound on El Camino Real, sometimes walking within the northbound lanes, then sometimes on the median, and occasionally veering into the southbound lanes as well. Wang said traffic was starting to back up because of the hazard. He added, "Cars were maneuvering to avoid hitting him and he just continued to walk in traffic", and, "It seemed like he had no regard for his own safety or the safety of the people that were (driving) in the roadway.

Wang continued by saying the male walked within the roadway for an "extended period of time," creating a more "exigent public safety matter," and continued to ignore Wang who kept his overhead emergency vehicle lights activated the entire time. Wang called for more assistance, recalling that he clarified with the communications dispatcher at the time that he was not "in pursuit" of the subject, but was instead forced to complete several U-turns to maintain a visual observation of the male.

At one point Wang accelerated away from the male, anticipating that he needed to make another U-turn

**CONTROLLED DOCUMENT**

Prepared By: 80251 DECKER, RICK	Date: 10/12/2018	Approved By: 80240 WARREN, JOHN	Date: 12/17/2018
------------------------------------	---------------------	------------------------------------	---------------------



CONTROLLED DOCUMENT

to re-approach the male again by traveling southbound on El Camino Real. He proceeded southbound on El Camino Real and noticed multiple SMCSO vehicles approaching "Code 3" from the opposite direction, seemingly responding to his call for assistance. The male started walking southbound on El Camino Real towards the vehicle for Deputy Alyssa Lorenzatti. Wang watched as Lorenzatti exited her vehicle and made a "forceful" hand motion towards the subject that to Wang indicated she was either ordering the male to the ground or ordering him to drop the bags in his hands. Lorenzatti was accompanied by Deputy John DeMartini. Wang indicated that he became "even more worried" because the subject was clearly larger in size and stature than both deputies and he "may be able to overpower" both of them, "if the altercation became physical."

Wang accelerated his vehicle to close ground and assist with contacting and possibly detaining the subject. As he approached he saw both deputies grab for the subject's arms and he responded by pulling away from their grasp, "flinging his hands in the air." Wang then exited his car and ran towards them. He grabbed the male's right hand and tried to secure it to the small of the subject's back in a "control hold", expecting to handcuff the male. However, he stated, "I wasn't physically able to place his right hand behind his back because his level of resistance was much stronger than my level of force and I could tell quickly I wasn't going to be able to control him myself."

Wang backed away from the subject to create distance between them, "because I wasn't physically able to control him." Wang admitted he was "getting a little scared...I'm not a big guy, I'm not a really strong guy but in most of my prior law enforcement encounters when I've had to physically restrain someone I'm usually able to gain control of one of their arms using both of my arms."

Wang stepped back while the male was still standing in the roadway and un-holstered his Taser, believing he would need to "try another force option beyond physical control." He released the thumb safety for the device and aimed it at the male's chest. He then warned the male, "If you don't comply (or) get on the ground you are going to get Tased." The male ignored the command and Wang deployed his Taser. He said, "I remember hearing the pop and...I hoped it would be enough to gain compliance from him." He added, "It seemed like it had an effect on him...I think he fell to the ground and I notified dispatch we had deployed a Taser." He then requested that a paramedic unit "stage" because of the Taser deployment, per SMCSO policy.

Wang said that the other deputies on the scene moved in and tried unsuccessfully to physically detain and/or handcuff the male while he was on the ground. The male continued to resist and Wang gave a second order for the male to "get on the ground and get on his stomach." He added, "He refused to comply and I activated my Taser for a second time." (*The X26 Taser is only loaded with one probe cartridge at a time so Wang is referring to activating the already deployed probes a second time, believing they were still in contact with the male.*) Wang said the male was "still very much agitated, speaking incoherently, excited," and still ignoring orders to roll over and lay on his stomach to be handcuffed. Wang deployed his Taser a third time. He said, "I remember thinking 'I hope this it...I

Prepared By:  
80251 DECKER, RICK

Date:  
10/12/2018

Approved By:  
80240 WARREN, JOHN

Date:  
12/17/2018





hope he realizes we can't just walk away'...I hoped he would just give up and surrender."

Wang watched as Deputy Bryan Watt now moved in and tried again to place the male in a control hold to be handcuffed but, "he was trying to pull away from Deputy Watt. I could tell he was still resisting at this point and so I believe I deployed my Taser a fourth time." The male continued to ignore orders from multiple officers and, "Was eventually able to get to himself to his feet on his own. He stood up and began to run eastbound (into) the northbound lanes of traffic."

Wang said, "At that point, I realize the Taser has been totally ineffective and...I'm going to have to resort to another means of force to detain him."

Wang said he dropped his Taser as the male ran within the traffic lanes. He removed his expandable baton and repeated the same orders to the male. He said, "Again, he made no physical or verbal indicators that he would comply." Wang said, "At this point I'm thinking, 'How are we going to be able to detain this guy? I've seen firsthand how strong he is...He never gave a window of opportunity for CIT training or dialogue...never acknowledged who we were or that he was open to trying to work this out verbally. "

Wang expanded his baton with his right hand and told the male, "Get on the ground." The male ignored the order and Wang swung his baton towards the male's lower leg, but missed. He said, "At that point I felt him tackle me...He grabbed on to me and pulled me to the ground...I saw something out of the corner of my eye and felt a hot stinging pain on the left side of my face. I didn't black out but knew something had hit me on the face." *In the various available videos of the event it appears at this point in the altercation that the male struck Wang in the face once if not multiple times.*

Wang then described how he was now on the ground and he could feel the male pulling on his duty belt, recalling the sensation that the male was pulling him "in one direction" by his duty belt. Wang thought, "If he reaches for my gun, I might be in a very bad situation. I felt scared that I couldn't stop (him) ...nothing I had done so far leading up to this had made him change his behavior or acknowledge my presence."

Wang said he recalled trying to stand up and trying to punch the male in self-defense, but, "I recall the motion of swinging my fist but don't remember ever feeling anything come into contact with my fist." Wang was not sure if his punch connected or if he missed. Wang remembered he then took out his OC spray and deployed it once he obtained "a clear view" of the male's face. He said, "Immediately upon deploying the OC I heard other deputies scream in pain," realizing he had missed the male with the OC. He then placed the container back in its holster.

Wang said, "At some point I remember looking or standing up and seeing he was handcuffed." Wang said the male was still thrashing about and that the deputies were still trying to prevent him from getting

CONTROLLED DOCUMENT

Prepared By: 80251 DECKER, RICK

Date: 10/12/2018

Approved By: 80240 WARREN, JOHN

Date: 12/17/2018



up. He remembered hearing the male "making noises" as one of the deputies confirmed that he was still breathing. Wang again called for paramedics and recalled getting "So frustrated" because it seemed to take them a long time to arrive.

The deputies then sat the male up and Wang used his knees to hold the male in a seated position. He watched as several other deputies seem to be washing OC spray out their eyes. He said, "Then someone told me, 'Hey Josh, go sit down.'" Wang was relieved of his duties and sat down on the tailgate of a nearby truck. He felt exhausted and was only able to speak in a low volume. He said, "I felt a wave of emotions and tried to process everything that had just happened."

Wang added that he eventually noticed CPR was being done on the subject and then Wang himself was escorted to an ambulance after realizing he was bleeding. He later learned that the subject had died and then it "really set in." *It should be noted that during his interview the cadence and level of detail regarding Wang's recollection of what occurred seemed to be sporadic after the point in the altercation when he was struck in the head.*

Once Wang completed his uninterrupted account of the incident, I asked some specific clarifying questions regarding the account he had just provided. Wang's responses are summarized here:

Wang confirmed for me that his patrol vehicle was clearly marked with SMCSO insignias on both doors, as well as overhead lights and the words "Sheriff" on both doors.

I asked Wang if he recognized the male from any prior contacts, crime alerts, or related law enforcement information and he replied, "No." At the time of this interview. Wang still did not know the decedent's name, now identified as Chinedu Valentine Okobi.

Wang said that after he made his first U-turn to contact Okobi, Okobi was no longer in the roadway and was instead on the sidewalk. He said that when he tried to get Okobi to stop by yelling, "Hey I need to talk to you," Okobi did not reply or even look at him. I asked him if he felt he gave Okobi a lawful order. He paused and then replied, "I think I said, 'Stop. I got to talk to you,'" while he had his overhead lights activated. *A review of the MAV footage from Wang's vehicle indicates that Okobi responded with, "What do you want?" (See supplemental prepared by Inspector Raffaelli.)*

I recalled for Wang an earlier statement when he felt "this was something more," after Okobi first ignored his order to stop. Wang said it was based on prior experiences when "people don't stop right away," when he pulls alongside them, which is why he deliberately accelerated past Okobi, into his line of sight, and stopped his car. He said that was when Okobi averted contact with him by walking back into traffic and on to the center median. Wang added, "At this point he had (indicated) that he was going to try to evade me," and that's why he called for more assistance.

CONTROLLED DOCUMENT

Prepared By:  
80251 DECKER, RICK

Date:  
10/12/2018

Approved By:  
80240 WARREN, JOHN

Date:  
12/17/2018





Wang estimated he made "numerous U-turns" trying to contact Okobi until additional officers arrived on scene to assist him.

Wang said that when he first tried to physically detain Okobi, he grabbed his right wrist, intending to place his arm behind his back. He elaborated, "When I say that, he (Okobi) easily overcame that, I mean he pulled his arm away from my grasp." He did not recall if Okobi said anything when he resisted.

I asked Wang to elaborate on the initial efforts to restrain Okobi. He described how Deputies Lorenzati and DeMartini had tried to control Okobi's arms first, but he pulled away from them. It was after that when Wang himself first tried to control Okobi's right arm, but Okobi pulled away from Wang as well. I asked Wang why he wanted to handcuff Okobi and he replied, "His behavior was unpredictable. He would not acknowledge any of my commands. He had already displayed indications that he was trying to evade by creating distance between myself and him and based on his physical stature, in order to prevent him from escaping...or attacking us I felt safer having him in handcuffs before we try to engage in some kind of meaningful dialogue."

I asked Wang how he ascertained that he could not physically control Okobi and he replied, "Based on the ease of which he was able to pull away from my grasp." Wang also remarked how apparent it was to him that Okobi was a large man, about 6'00 tall, about 250 lbs. *It should be noted that Okobi's stature at the time of death was approximately 6'3", 337 lbs.*

Wang was unsure if Okobi was looking at him when he first warned him that he was going to Tase him, but he was certain Okobi was facing him and only about 8 feet away, and still walking southbound on El Camino Real within the lanes of traffic, when he deployed the Taser.

I asked Wang if Okobi had a physical reaction to being Tased the first time and he replied, "I saw his body tense up and I think he fell to the ground." Wang and the other deputies continued giving Okobi orders as he was still on the ground and after the first Taser activation had ended. Okobi continued to resist as the two deputies tried again to handcuff him. Wang gave Okobi orders, yelling, "Get on your stomach now," and warned him he would be Tased again if he did not comply.

I asked Wang about the second use of the Taser, which he clarified was the re-activation of the previously deployed probes, by pulling and releasing the trigger. I asked what physical reaction Okobi had to the second Taser deployment and he replied, "Nothing." Wang said he had no idea if the probes were still in contact with Okobi, or in any position to be effective, but he recalled that Okobi had no physical reaction to this second deployment. He said Okobi continued to physically resist the deputies, recalling that Deputy Watt tried again to physically detain Okobi, but was unsuccessful.

I asked Wang then if he had any idea if the probes were still in contact with Okobi, or in any position to be effective, prior to the 3<sup>rd</sup> deployment, which was a re-activation of the same probes and he replied, "I

CONTROLLED DOCUMENT

Prepared By:  
80251 DECKER, RICK

Date:  
10/12/2018

Approved By:  
80240 WARREN, JOHN

Date:  
12/17/2018



CONTROLLED DOCUMENT

don't." He did not recall seeing the Taser wires at all.

I asked Wang how far Okobi was from him prior to the 3rd Taser activation. Wang said he was "about 6 to 8 feet" away and still on the ground, lying on his back, "moving...it wasn't a motion like he was trying to comply with my order to roll over on his stomach...he was flailing." He continued to order Okobi to "get on his stomach" just before activating his Taser a 3rd time. He pulled and released the trigger of the Taser (allowing for a 5 second pulse) and he saw that Okobi started to get up off the ground. He could not remember if Okobi showed any symptoms of being Tased during this third activation and was unsure if Okobi got off the ground during or just after the 5 second pulse from this third activation.

Wang said that once Okobi got up he still had no idea if the probes of the Taser were engaged or if they were in contact with Okobi. He recalled seeing a "clump" of copper wires, but did not know if the probes were attached once Okobi successfully stood up. He said Okobi, "was still uncompliant (once he got up)...his body language never indicated he was surrendering or giving up." Wang said Okobi was again resisting efforts to be physically restrained, pulling away from Sergeant Weidner and Deputy Watt.

I asked Wang about his position in relationship to Okobi's position just prior to his fourth Taser activation. He said Okobi was "gaining distance between us, starting to run eastbound (within the lanes of) El Camino." Wang recalled the deputies following and "yelling" at Okobi but he could not recall specifically what orders they were giving Okobi. *Wang remained uncertain during the interview if he actually activated the Taser a fourth time, but at this moment when he believed he may have, he had NO recollection of Okobi reacting to being affected by the Taser in any way.* He added that after reviewing his MAV video prior to the interview, he recalled hearing the "clicking" of his Taser during this moment as Okobi walked away from him and an unknown person told Wang to "turn it off."

Wang confirmed that he completed his certified, 40 hour training in Crisis Intervention while he was a member of the San Francisco Police Department, but added that he "never had a chance" to use the training in this situation.

I asked Wang to elaborate on his unsuccessful attempt to strike Okobi in the legs with his baton. I asked him his justification for the attempt and he replied, "My justification was prior use of force had been ineffective, his level of resistance had increased since the initial contact and was escalating and I was still trying to affect a detention...affect an arrest...and lower levels of force were ineffective and I believe I needed to transition to another use of force."

I asked Wang if he believed Okobi was a danger to himself or the community and he replied, "Yes, him running in the roadway represented a danger to himself, a danger to the community...and in addition to committing the crimes (resisting arrest), establishing his mental wellbeing was a factor...and there maybe the criteria to justify a mental health detention or mental care for an altered state of mind."

Prepared By: 80251 DECKER, RICK	Date: 10/12/2018	Approved By: 80240 WARREN, JOHN	Date: 12/17/2018
------------------------------------	---------------------	------------------------------------	---------------------



CONTROLLED DOCUMENT

Upon further questioning about being struck in the face, Wang said he believed Okobi had struck him with his hand, knocking Wang to the ground. Wang said, "I remember feeling a force over my body, pushing me in some direction."

I spoke to Wang about his trying to punch Okobi after he had been punched and knocked to the ground. Wang believed he missed Okobi with both punches, saying he felt no pain in his hand then or today, adding, "The fact that I don't feel any pain in my hand at all makes me think that I must not have connected with him." I asked him for his justification for trying to punch Okobi in the face and he replied, "At that point I had utilized physical control which was ineffective in terms of control holds, I had utilized my Taser which was ineffective, I had utilized my baton which was ineffective, partly because I missed, and at that point I didn't have any other force options...I felt like all of his actions and aggressions was specifically towards me and I felt a sense of hopelessness...(He thought) I don't know what I have to do to get him restrained..." He recalled again someone was "tugging" on his duty belt after he was down, but "I don't know if he was grabbing at my gun." He later added he was unsure if it was Okobi that was tugging at his belt.

I asked Wang when if ever he feared for his safety and he replied, "I felt like I couldn't stop him...it was a sense of hopelessness, a sense of fear." Wang admitted his memory of what happened after being punched in the head was "cloudy".

I asked Wang what he meant earlier in the interview when he said that Okobi was "writhing back and forth" after being handcuffed. He clarified, "He was still moving...still moving his body around...still requiring us to maintain active control of him...once the handcuffs went on it wasn't like he immediately surrendered." I asked if Okobi's breathing was ever restricted and he replied, "No."

I asked Wang specifically if a carotid restraint or headlock was ever used on Okobi and he replied, "No." He added, "Neither myself nor any other deputy had any hand near his face or neck other than when I tried to punch him (and missed)."

I asked Wang if he was injured as a result of the altercation. He said his right knee is "sore and stiff", his neck is "sore", has face hurts (there was a visible injury presumably from being punched) and he had pain to his right wrist. He explained that he was treated and released from the hospital in about an hour.

I asked Wang if he had previously deescalated other situations using his CIT training. He recounted an incident about a month ago when a female had attacked her mother and he was able to build a rapport with her verbally, allowing the female to be placed on a 5150 W&I hold without further incident or physical altercation.

I asked Wang when he was qualified to carry the Taser since joining the SMCSO and he said it was

Prepared By:  
80251 DECKER, RICK

Date:  
10/12/2018

Approved By:  
80240 WARREN, JOHN

Date:  
12/17/2018



about a month ago after an 8 hour training course presented by a department Taser instructor.

At the conclusion of the interview, I asked Wang if he wanted to add anything that perhaps we had not yet spoken about. He paused and said, "It's not something that you can answer but it's just what's going on in my head. I just can't figure out why this happened. I don't know why he (Okobi) did that. I don't know anything about him. I've never seen him before, never had any prior contacts with him. I don't know if he did it...I just don't know why it went to shit so quickly and why it turned out like this...there was no communication between me and him. It would be easier to understand (what happened) if he just said 'fuck you'." Wang seemed at a loss to understand the reason behind Okobi's behavior and his physical resistance to the deputies involved in the event.

**Disposition:**

Attach to Original Report

**CONTROLLED DOCUMENT**

Prepared By:  
80251 DECKER, RICK

Date:  
10/12/2018

Approved By:  
80240 WARREN, JOHN

Date:  
12/17/2018



**INTERVIEW WITH DEPUTY JOSHUA WANG**

**Q=Insp. Rick Decker**

**Q1=Zeb Davis**

**A=Deputy Joshua Wang**

1  
2  
3  
4  
5  
6  
7 Man: Okay.  
8  
9 Q: Now that we got all the electronics squared away. Okay. It is Thursday  
10 October 4. It is 1:30 pm. Um, we're going to go ahead and do some  
11 introductions. My name is Rick Decker. I'm an inspector with the San Mateo  
12 County District Attorney's Office.  
13  
14 A: My name is Joshua Wang. I'm a Deputy Sheriff for the San Mateo County  
15 Sheriff's office.  
16  
17 Q1: And I'm Zeb Davis I'm with the Mastagni Holstedt Law Firm.  
18  
19 Q: Okay, thank you. So the first thing officer I want to confirm is that you, uh -  
20 uh, you're here voluntarily.  
21  
22 A: Correct.  
23  
24 Q: Okay, correct. And no one has ordered you to be here?  
25  
26 A: No.  
27  
28 Q: Okay. So you're here by your own free will?  
29  
30 A: Correct.  
31  
32 Q: Okay. Um, so what we're gonna do is - is in this county there is a protocol.  
33 There are some questions I will ask. Not all of them may apply. I try to catch  
34 the ones that don't apply, but if I spit out a question that makes absolutely no  
35 sense, just answer the best you can.  
36  
37 A: Okay.  
38  
39 Q: Um, again some of this does not apply to the situation. Uh, during the  
40 interview I will make reference to the incident, which is makes - obviously the  
41 - the thing that we're here to talk about.  
42  
43 A: Okay.  
44  
45 Q: Um, but I'll - I'll use that term when I say - when I'm asking you, like, prior

46 to the incident, after the incident. That kind of thing.  
47  
48 A: Okay.  
49  
50 Q: Um, some of this is a little bit of background information as far as, um, where  
51 you were mentally and physically before-hand, afterward - that kind of thing.  
52 Some of it is pretty basic as far as your attire and that kind of thing.  
53  
54 A: Okay.  
55  
56 Q: Okay? Um, again if you have any questions whatsoever, if you need any  
57 verification, you're welcome to ask. Uh, if you need to take a break, take a  
58 break. This is all done at your own pace from beginning to end. If you need to  
59 step outside and take a break, water, restroom, whatever. Again if I ask  
60 anything that you feel you need to confer with your council, just let me know.  
61 Again you'll - we'll step out - out of the recorder room and you can have  
62 some privacy next door.  
63  
64 A: Okay.  
65  
66 Q: Okay? All right. So we're gonna start with some easy stuff. What's your full  
67 name?  
68  
69 A: Joshua. Middle name is two - two names. L-E-E.  
70  
71 Q: Mm-hm.  
72  
73 A: Space. J-O-O-N-G. My last name is W-A-N-G.  
74  
75 Q: Okay. And what is your badge number?  
76  
77 A: 1100.  
78  
79 Q: 1100. And you're with the San Mateo County Sheriff's Office?  
80  
81 A: Correct.  
82  
83 Q: Okay. How long have you been employed there?  
84  
85 A: Since February 26th of 2018.  
86  
87 Q: Okay. Were you employed anywhere in law enforcement before then?  
88  
89 A: Uh, I was.  
90

91 Q: Okay.  
92  
93 A: I worked for the San Francisco Police Department as a police officer.  
94  
95 Q: Okay.  
96  
97 A: I graduated from the academy May of - May 5th of 2013.  
98  
99 Q: Okay.  
100  
101 A: And, um, I was employed there all the up until I was hired by San Mateo  
102 County.  
103  
104 Q: Okay. And did you work with anyone else as far as law enforcement before  
105 that?  
106  
107 A: Uh, I volunteered for the San Carlos Police Department. Um, this was around  
108 2008 to 2009. It was, uh, one day a week kind of...  
109  
110 Q: Okay.  
111  
112 A: ...volunteer.  
113  
114 Q: You say you were a volunteer. Were you, uh, reserve or were you someplace  
115 else?  
116  
117 A: I was a volunteer. Unpaid.  
118  
119 Q: Unpaid?  
120  
121 A: Unpaid.  
122  
123 Q: Okay.  
124  
125 A: Um...  
126  
127 Q: Did you have any law enforcement related duties, or just...  
128  
129 A: Um, I wrote parking tickets. I towed some abandoned vehicles. I set up  
130 electronic sign boards. Um, I think I took cars to the car wash. Um, marked  
131 abandoned vehicles.  
132  
133 Q: Okay.  
134  
135 A: That was about the extent of my duties.



136  
137 Q: So then, uh, I have to do the math. So in terms of being a sworn police officer,  
138 how many years has it been for you?  
139  
140 A: Uh, a little over five.  
141  
142 Q: Okay. And then whether it be SFPD or the Sheriff's Office, what assignments  
143 have you had?  
144  
145 A: Uh, so I'll start with San Francisco. Um, after the academy I, um, I did FTO at  
146 Tenderloin Station. I did my year of probation at Northern Station, and I was  
147 assigned to Mission Station for my permanent assignment.  
148  
149 Q: Okay.  
150  
151 A: Um, I - I was in patrol the whole time I was in San Francisco.  
152  
153 Q: Okay.  
154  
155 A: I was - I was, um, a part of the San Francisco Police Department Specialist  
156 Team. Which is, um, ancillary duties in addition to patrol. Um, you respond to  
157 - the typical duties include responding to critical incidents in progress. Um,  
158 helping SWAT serve high risk search warrants. Um, extra security for, um,  
159 protests and demonstrations and things like that.  
160  
161 Q: Okay. And now outside your employment with the sheriff's office. Are you  
162 employed in any other way?  
163  
164 A: No.  
165  
166 Q: Do you make...  
167  
168 A: No.  
169  
170 Q: Nothing else?  
171  
172 A: No.  
173  
174 Q: Okay. Uh, and then outside of the training provided by the Sheriff's Office.  
175 Do you have any - are you currently doing any secondary education?  
176  
177 A: No.  
178  
179 Q: Okay. How 'bout like, uh, any kind of hobbies, sports, anything like that?  
180

181 A: Uh, I like to exercise - work out. I like to travel.  
182  
183 Q: Okay. And do you have any military background?  
184  
185 A: I don't.  
186  
187 Q: Okay. Any background in martial arts or anything as far as hand-to-hand?  
188  
189 A: Uh, I did martial arts when I was a little kid.  
190  
191 Q: Okay.  
192  
193 A: That's, uh...  
194  
195 Q: Okay.  
196  
197 A: When I was in San Francisco I - I went to one class of, like, Brazilian -  
198 Brazilian Jiu Jitsu.  
199  
200 Q: Okay.  
201  
202 A: Um, one of the officers up there owns a dojo or - and I - I went for one class...  
203  
204 Q: Okay.  
205  
206 A: ...and that was it.  
207  
208 Q: Okay - okay. And, uh, in terms of, uh, do you have a dominant hand? Right  
209 handed? Left handed?  
210  
211 A: Um, right handed.  
212  
213 Q: Okay and then so I assume you do most everything right hand.  
214  
215 A: Yes.  
216  
217 Q: Write - okay, yeah.  
218  
219 A: Yeah.  
220  
221 Q: Okay. Now let's start with your attire of the day of the incident. We'll call  
222 yesterday. Um, walk me through whatever direction you're comfortable. Head  
223 to toe. Toe to head - what you were wearing yesterday when you were on  
224 duty.  
225

226 A: Okay. I'll start from head-to-toe.  
227  
228 Q: Okay.  
229  
230 A: I was wearing, um, a long sleeve, um, wool, um, blue uniform shirt. Um, I had  
231 my badge displayed on the left side of my chest. Um...  
232  
233 Q: Is that a, um, metal badge? Cloth badge?  
234  
235 A: It's a metal badge.  
236  
237 Q: Metal badge? Okay.  
238  
239 A: It's either brass or gold.  
240  
241 Q: Okay.  
242  
243 A: I'm not sure. Um, I had two, um, San Mateo County Sheriff's office patches  
244 on each of my arms, right below the shoulder. Um, I was wearing, uh, my  
245 name tag - a metal name tag- on the right side of my chest. Um, I was wearing  
246 a - a duty belt. Like a Sam Brown basket weight belt, with all of my issued  
247 equipment. I was wearing, um, my long - long wool pants. They're dark blue  
248 in color.  
249  
250 Q: Okay.  
251  
252 A: Um, and I was wearing black - black Danner boots.  
253  
254 Q: Okay. Is this what you would describe as a Sheriff's office patrol uniform?  
255  
256 A: Correct.  
257  
258 Q: Okay. Um, and then did you have anything else on you? Did you have, like, a  
259 necktie anything like that?  
260  
261 A: Uh, no necktie. I was wearing my, um, radio microphone...  
262  
263 Q: Okay.  
264  
265 A: ...wrapped around my back, through my shoulder and clicked onto the front of  
266 my chest.  
267  
268 Q: Okay.  
269  
270 A: And, um, I was wearing the, uh, microphone to my vehicles, um, MAV device

271 I believe on my left, uh, or my right shoulder.  
272  
273 Q: Okay. Uh, any - any turtle neck with any department markings? Anything like  
274 that?  
275  
276 A: Uh, no.  
277  
278 Q: Okay. And now if you start you said you're right handed.  
279  
280 A: Correct.  
281  
282 Q: So I'm gonna assume your - your firearm holster's on your right hip?  
283  
284 A: Correct.  
285  
286 Q: Okay so whatever direction you're coming from, walk me around your Sam  
287 Brown, as far as what you have equipped on that belt.  
288  
289 A: Okay. So starting in the middle working, um, my clockwise. The first thing is  
290 a tourniquet, uh, a tourniquet in a tourniquet holder. Um, next to that is my,  
291 um, OC spray in a, uh, OC holder. Um, next to that is what's called a Zak  
292 Tool. It's like a key-chain clip that I can clip keys on quickly. Um, next to that  
293 is my firearm in - in a holster. Um, next to that - as you continue around back  
294 is one set of handcuffs in a holder, next to that is another set of handcuffs in a  
295 holder. Um, next to that is my radio - my department issued radio in a radio  
296 holder. Um, next to that is my, uh, department issued expandable, or  
297 collapsible baton. Next to that is my, um, department issued Taser in a holder.  
298 Next to that are two magazines for my fire arm.  
299  
300 Q: Okay. And your Taser. What - what manner is that set to be drawn?  
301  
302 A: Uh, it's set to be drawn for a non-dominant hand draw.  
303  
304 Q: Okay. So if you would be...  
305  
306 A: Left hand.  
307  
308 Q: ...left hand draw.  
309  
310 A: Correct.  
311  
312 Q: Um, and then, uh, goes without saying, but yesterday you were on duty...  
313  
314 A: Correct.  
315

316 Q: Is that a normal day for you? An over-time day?  
317  
318 A: It was a normal day.  
319  
320 Q: Okay. And then describe to me in terms of what - what is your shift calendar?  
321 How often do you work each week?  
322  
323 A: So, um, the San Mateo County Sheriff's Office works in a four team schedule.  
324 Team's one and two are day shift schedules. Teams three and four are - are  
325 night shift schedules. Um, Team One and Two work from 0600 to 1800. And  
326 I'm on team one. So I work from 0800 to 1600 on my regular work days.  
327  
328 Q: Okay.  
329  
330 A: And the days that I work, um, rotates every week.  
331  
332 Q: Okay.  
333  
334 A: So, um, so one week I'll work, um, Monday, Tuesday. I'll be off Wednesday,  
335 Thursday, and then I'll work Friday, Saturday, Sunday. And then the  
336 following week I would work Wednesday, Thursday, and then, uh, and then -  
337 I'm sorry. I'd work Wednesday, Thursday, and be off Friday, Saturday,  
338 Sunday.  
339  
340 Q: Okay. So for yesterday - on the day of the incident. Uh, had you, uh, where  
341 was that in your work week? Was that...  
342  
343 A: That was the first day of my regular work week.  
344  
345 Q: Okay. So I assume you were off the day before?  
346  
347 A: I worked an over-time shift the day before.  
348  
349 Q: Okay. Tell me about the over-time shift the day before.  
350  
351 A: Uh, the over-time shift, um, I was assigned out of the Mill- Millbrae  
352 Substation. I was assigned to the Boy 40 beat.  
353  
354 Q: Okay.  
355  
356 A: Which is, uh, includes the Eichler Highlands of, uh, San Mateo County.  
357  
358 Q: Okay. So on the day before when you worked over-time with the Boy 40 beat.  
359 What was your shift? What was the schedule?  
360

361 A: I worked from, uh - uh, team two schedule. Which works - is 0600 to 1800  
362 hours.  
363  
364 Q: Okay. So did you get off at normal time?  
365  
366 A: I did.  
367  
368 Q: 1800 hours?  
369  
370 A: Correct.  
371  
372 Q: Okay. And then the night before the shift in question. Uh, how much sleep did  
373 you get?  
374  
375 A: Uh, let's see. Probably went to sleep around 10:30 to 11 o'clock. And I wake  
376 up at 4:30 in the morning. So 10, 11, 12, 1, 2, 3 - that's 6 hours.  
377  
378 Q: 6 hours? Is that normal for you/  
379  
380 A: Yes.  
381  
382 Q: Okay. The night before, uh, whether it was with dinner or not. Did you have  
383 any alcohol to drink the night before?  
384  
385 A: Uh, the night before on...  
386  
387 Q: The night between - between your overtime shift...  
388  
389 A: Correct.  
390  
391 Q: ...at Millbrae and yesterday's shift.  
392  
393 A: I did.  
394  
395 Q: Okay.  
396  
397 A: I did have alcohol.  
398  
399 Q: Okay. And that was the night before?  
400  
401 A: Correct.  
402  
403 Q: Okay. What did you have to drink?  
404  
405 A: I drank two Micheladas and a Coors light.

406  
407 Q: Okay. And, um, and then, uh, you went to bed you said around...  
408  
409 A: Around 10 to 11:00.  
410  
411 Q: Okay.  
412  
413 A: 10:30.  
414  
415 Q: And then when you got up at 4:30 until your shift began yesterday 8:00 am  
416 did you have any alcohol?  
417  
418 A: At 6:00 am.  
419  
420 Q: Sorry, 6:00 am.  
421  
422 A: Yeah.  
423  
424 Q: Yesterday's shift started at 6:00 am?  
425  
426 A: Uh, yeah. 0600 to 1800...  
427  
428 Q: Okay.  
429  
430 A: ...is my shift time.  
431  
432 Q: And did you have any alcohol from the time you woke up...  
433  
434 A: No.  
435  
436 Q: ...to when you started your shift? Okay. Uh, do you take any medication?  
437 Anything over the counter anything?  
438  
439 A: Uh, I take a supplement.  
440  
441 Q: Okay.  
442  
443 A: I think - my wife tells me to take it. Some kind of...  
444  
445 Q: I think we all have those.  
446  
447 A: Yeah.  
448  
449 Q: Okay.  
450



451 A: Um...

452

453 Q: Just something health related?

454

455 A: Yeah.

456

457 Q: Okay.

458

459 A: But no - no medication.

460

461 Q: Okay. Um, and then, when you woke up at 4:30. Tell me just in summary,

462 what did you do prior to your shift?

463

464 A: Um, I woke up. I got out of bed. Uh, I went and used the bathroom - took a

465 dump, I guess. Um, brushed my teeth, washed my face, put on my clothes,

466 packed my - packed my lunch and food for the day. Um, got dressed and

467 drove to the station.

468

469 Q: Okay. Uh, did you do anything significant or anything out of the ordinary

470 prior to your shift?

471

472 A: No.

473

474 Q: Before getting on uniform? Okay. Um, and then about what time did you start

475 putting on your uniform for you shift?

476

477 A: About 5:30.

478

479 Q: Okay. So for yesterday's shift...

480

481 A: Mm-hm.

482

483 Q: ...which again began at 6:00 am.

484

485 A: Mm-hm.

486

487 Q: Uh, who is your direct supervisor?

488

489 A: Uh, Sergeant Dave Weidner.

490

491 Q: Okay. Um, and did you have any kind of a morning briefing?

492

493 A: Yes.

494

495 Q: Okay. What - what, uh, talk about anything significant during morning

496 briefing?  
497  
498 A: Nothing - nothing abnormal. Um, talk about what happened the shift before.  
499 Things that are going on in the Millbrae - in our - in our patrol area. Any, uh,  
500 emails the captain sent out. Um, nothing - nothing abnormal.  
501  
502 Q: Okay. And let me back up for your over-time shift. Anything significant  
503 happen during that shift?  
504  
505 A: No.  
506  
507 Q: Any - any significant use of force? Any stressful - high stress calls?  
508  
509 A: No.  
510  
511 Q: Nothing out of the ordinary? Okay. Uh, so regarding the incident we're going  
512 to talk about from morning briefing to that. Anything significant happen  
513 there? Any calls out of the - you know anything unusual? High stress? Any  
514 use of force?  
515  
516 A: Um, earlier - prior to the incident in question. Um, another deputy requested a  
517 code 3 cover, so I responded code 3 - which is lights and sirens. Um, and a  
518 most expedient manner. Um, code 3 driving is not extremely rare, but it's also  
519 - I don't - but it's also not a daily routine.  
520  
521 Q: Okay.  
522  
523 A: So, um, that was kind of significant.  
524  
525 Q: Okay any other - any other notable calls you handled before this? During -  
526 during yesterday's shift?  
527  
528 A: No.  
529  
530 Q: Okay.  
531  
532 A: Prior - prior to the incident, no.  
533  
534 Q: No. Okay. Um, and then, uh, how were you feeling physically yesterday when  
535 you - when you started your shift?  
536  
537 A: I felt fine.  
538  
539 Q: Felt fine?  
540

541 A: I felt good.  
542  
543 Q: Okay and, uh - uh, emotionally, mentally, any issues? Anything on your  
544 mind?  
545  
546 A: Um, no. My wife and I have some vacation planned so I was lookin' forward  
547 to those. I was kind of, you know?  
548  
549 Q: Counting the days.  
550  
551 A: Counting the days and hours, yeah.  
552  
553 Q: Fair enough. Okay. And now, uh, where were you, um, when you got, um,  
554 where were you just before this incident started. Like the last call you handled  
555 or the last proactive thing you did. Whatever it was.  
556  
557 A: Um, the last call prior to the incident would have been probably much - much  
558 earlier in the morning. There was - there was a big lag in terms of calls for  
559 service. I responded code 3 to assist another deputy, and I don't believe I  
560 handled - I don't believe I handled any other service up until the incident.  
561  
562 Q: Okay - okay. So now this is the point in the - the discussion so I'm going to let  
563 you - in your mind's eye, whatever you decide that is for the time frame of  
564 this. I want you to start when - in your opinion when this incident began.  
565  
566 A: Okay.  
567  
568 Q: I want you to walk me through kind of a narrative, um, portrayal of what  
569 happened.  
570  
571 A: Okay.  
572  
573 Q: Up until the point when you would consider it to be over, or done or you  
574 know, when it ended essentially for you.  
575  
576 A: Okay.  
577  
578 Q: Um, again I'm not gonna do my very best to interrupt - to not interrupt you.  
579  
580 A: Okay.  
581  
582 Q: Obviously your counsel's more than welcome to interrupt you if he needs fit.  
583 But the goal here is that you can just provide an uninterrupted account of what  
584 happened.  
585

586 A: Okay.  
587  
588 Q: Uh, if you miss something, feel free to back up.  
589  
590 A: Okay.  
591  
592 Q: Just tell me you're backing up so I can keep track of the chronological, uh,  
593 events. Again, don't pay attention to me keeping notes.  
594  
595 A: Okay.  
596  
597 Q: And if at any point again you feel you need to confer with council, let me  
598 know and we'll take a break, and you can step outside. Okay?  
599  
600 A: Okay.  
601  
602 Q: Okay. Go ahead.  
603  
604 A: Um, I was driving mark patrol vehicle number 10. It's not my usual patrol  
605 vehicle. My usual patrol vehicle is car number 3. That's a marked Ford  
606 Taurus. Um, but that - my - my regular patrol vehicle had been sent to the  
607 shop for maintenance, so I was driving marked patrol vehicle number 10. It's  
608 a Ford Explorer. Um, I was logged into the MDT. I was logged into the - the  
609 MAV device. The - my microphone was activated. Everything was as it  
610 should be. Um, I was driving south bound on El Camino Real in Millbrae  
611 approaching the intersection of El Camino Real and Millwood when I started  
612 approaching the intersection, I saw someone, which looked to me like a male.  
613 Um, walking east bound on Millwood through - crossing El Camino across,  
614 um, three lanes of traffic. And from my perspective, it looked like the male  
615 had stepped into the intersection, almost walking into the intersection of  
616 Millwood and El Camino Real. Um, when he was not permitted to do so and I  
617 base that upon the fact that, I saw a green light facing me making - leading me  
618 to believe that I could lawfully proceed through the intersection. Um, and  
619 there was a pedestrian standing in the road way at the time. Um, as I got closer  
620 to the intersection, the subject stepped onto the median. Um, and I - I was  
621 almost adjacent to the suspect. Um, just sort of based upon my observed, uh,  
622 my observation that this person may have violated the California vehicle code,  
623 and in that I was not assigned to a call for service, and I was in patrol, in my  
624 assigned beat. Um, I decided that I would make a traffic enforcement stop of  
625 that subject and contact him. Um, I activated my overhead emergency lights,  
626 so I could conduct a U-turn and safely without, uh, getting struck by cars  
627 traveling north bound on El Camino Real. Once the intersection was clear, I  
628 made the U-turn and I pulled up alongside the same subject I had seen in the  
629 road way. Um, he was walking north bound on El Camino Real, on the east  
630 side of the sidewalk. Um, I saw that he was an African American male. Fairly

631 large in stature, holding numerous bags. Um, my usual approach into when I  
632 want to stop pedestrians when I'm in a patrol vehicle is to pull up alongside  
633 them, roll down my window and verbally contact them and let them know that  
634 I intend to stop them and that - and that I need to talk to them. So I pulled up  
635 alongside the subject, I rolled down my window and I said something along  
636 the lines of, "Hey, I need to talk to you." Or "Hey, stop hold on for a minute."  
637 Just let him know that he - I didn't want him to continue walking. Um, he  
638 continued to walk north bound on El Camino. Um, so I accelerated quickly to  
639 give myself a little bit of a gap so I had time to pull my car over to the curb,  
640 exit the vehicle, and approach the person before, um, and still give myself a  
641 little bit of reactionary gap. Um, at that point after I accelerated, I saw the  
642 subject continue to walk and he was now walking in the road way to my left,  
643 and still walking north bound on El Camino Real. Um, I know El Camino  
644 Real to be a, uh, heavily trafficked road way, with, um, multiple lanes of  
645 traffic. Cars traveling at speeds of 35 miles per hour or more, typically. Um, at  
646 that point I thought this - this simple detention had turned into something  
647 more. I thought I was - I was bound to this subject now. I couldn't just drive  
648 away and say, "Hey, next time don't do that." I thought I can't just drive  
649 away. Now he's walking in traffic. He may get struck by a vehicle. Um, he  
650 may cause an accident. A car my swerve to avoid colliding with him. So I  
651 continued to maintain a visual observation of the subject. Um, I notified  
652 county communications that, um, I was trying to effect a stop of a pedestrian  
653 and that - and that I would need additional help to do so. I didn't think - I  
654 didn't think I would be able to safely stop the subject, while be mindful of  
655 traffic flowing in both the northbound and southbound direction. Um, and so I  
656 - I request another unit. The subject continued to walk in and out of traffic.  
657 Still north bound on El Camino. Sometimes he would walk into the south  
658 bound El Camino lane, sometimes he would walk on the median. Um, I could  
659 see that cars were backing up. Cars were maneuvering to - maneuvering to  
660 avoid hitting him, and he just continued to walk in traffic. It seemed he had no  
661 regard for his own safety or the safety of the people that were in the roadway.  
662 Um, after - after what I felt like was an extended period of time. I - it seemed  
663 like he was gonna continue - continue walking in the road way. And, um, I  
664 thought, now this is exigent public safety matter so I - I requested more - more  
665 units to come code 3, as quickly as possible. Um, and this whole time my  
666 overhead emergency lights were activated and I was - I was - some - someone  
667 asked if I - dispatch asked if I was in pursuit of the subject. And at first I  
668 didn't know how to explain to them that I wasn't in pursuit of him, and that I  
669 was just trying to maintain a visual observation of him until more units could  
670 arrive. Um, I didn't want them to think it was some kind of, um, high speed  
671 pursuit or anything like that. I just wanted to let them know. So I told them,  
672 um, I wasn't in pursuit of him. I wasn't even behind him really at that point. I  
673 was just kind of paralleling him and maintaining visual observation. Based  
674 upon his behavior, this required me to conduct numerous U-turns on El  
675 Camino - sometimes driving against traffic. Um, and at one point due to the -

676 the medians on El Camino I had to proceed northbound away from the subject  
677 to the next intersection to make a U-turn so I could come back to keep a visual  
678 of the - of the subject who was continuing to just walk in the road way. Um,  
679 so as I - as I conducted a U-turn and started driving back southbound towards  
680 the subject, I saw in the distance multiple emergency vehicles, which I  
681 presumed were sheriff's deputies come in code 3. I saw, um, I saw Deputy  
682 Lorenzatti driving a Ford Taurus, which I know to be her regular vehicle. Um,  
683 driving northbound in the south bound, um, - she was driving northbound, in  
684 the southbound lanes of El Camino Real. I saw another - I believe a Ford  
685 Taurus, which is - was another marked vehicle. Um, approach and I saw, um,  
686 the subject walking southbound on El Camino, um, towards Deputy  
687 Lorenzatti. And I saw Deputy Lorenzatti quickly exit her vehicle. I saw her  
688 motioning with her hands, pointing to the ground, in a forceful manner. And I  
689 believed that she was ordering the subject to, um, surrender and either place -  
690 place the bags he was holding on the ground or place himself on the ground.  
691 Um, while that was happening, I saw Deputy John DeMartini approaching the  
692 subject. Um, I saw that the two of them were both physically smaller in size  
693 than the subject. Um, I saw - and - and they were both shorter than the subject,  
694 and they were significantly less - less heavy as the subject. Um, at that point I  
695 - I became - I was - I became even more worried. Um, based on the subject's  
696 size, um, I thought that he may be able to physically over-power both Deputy  
697 DeMartini and Deputy Lorenzatti if - if altercation came to, uh, escalated to  
698 some type of physical altercation. I saw both Deputy Lorenzatti and  
699 DeMartini standing there and the - the distance between them and the subject  
700 was closing. Um, and based upon that I accelerated through kind of a sea of  
701 cars to get closer, so I could get out of my car and assist them in detaining the  
702 subject. Um, as - as I was getting closer, I saw them try - try and take physical  
703 control of the subject. It looked like they were trying to grab the subject's  
704 arms in an attempt to control his hands. And I saw that he was able to over-  
705 come their - their attempts to physically control him, and they were not able to  
706 control his hands and he flung his arms in the air. Um, didn't seem like there  
707 was much they could do to stop him. So I exit my patrol vehicle. I ran towards  
708 them. I try - I grab a hold of the subject's right hand, and I tried to pull it  
709 behind his back into a handcuffing position. Um...Once I believe that - once is  
710 - if I can get his right hand behind his back, I could use, um, pain compliance  
711 control hold. Like a bent wrist - bent wrist lock to, um, get him to comply and  
712 put his left hand behind his back, and then we could handcuff him. I wasn't  
713 physically able to place his right hand behind his back, he was - he was - his  
714 level of resistance was much stronger than my level of force, and I could tell  
715 quickly that I wasn't going to be able to physically gain control of him myself.  
716 Um, at that point I thought, um, I need to create distance between myself and  
717 him in order to protect myself because I'm not - I wasn't physically able to,  
718 uh, control him. Um, that - I felt - I - I was getting a little scared. Um, I felt  
719 that, um, I'm not a big guy - I'm not a really strong guy, but in most of my  
720 prior law enforcement encounters where I have to physically restrain

721 someone, I'm usually able to gain control of one of their arms, using both of  
722 my arms. Um, so I thought I need to create distance and back away from him.  
723 I stepped back. At this point he was still standing in the roadway of El Camino  
724 Real. I thought I should try another force option beyond physical control and I  
725 unholstered my holster, using my non-dominant hand. I deactivated the safety  
726 of my Taser and shined the, um, the red dot - the flashlight - on his chest. Um,  
727 and I told him, and I gave him a verbal command and said, "If - if you don't  
728 comply. Or if you don't get on the ground, then you'll get Tased." My sole  
729 purpose for wanting him on the ground was it may be easier to place him in  
730 handcuffs and get control of his hands. Um, after I gave the verbal warning he  
731 did not comply. He did not lower himself to the ground. Um, and I pulled the  
732 trigger of my Taser and, um, shot him with my Taser. Um, I remember  
733 hearing the pop sound from the Taser and I felt a lot of anticipation because I  
734 was - I was hoping that it would work. I had never deployed a Taser on a live  
735 person before. Um, and I hoped that it would - it would be enough to gain  
736 compliance from him. Um, it seemed like it had some type of effect on him.  
737 Um, I could tell that he felt some discomfort, um, I think he fell to the ground  
738 at that point. And I notified dispatch that we had deployed a Taser and I  
739 wanted to keep the radio channel clear in case we needed to broadcast  
740 emergency traffic. I believe I requested a - a medic to stage due to our policy  
741 and due to the fact that he may be injured as a result of the Taser deployment.  
742 Um, once he was on the ground other deputies had arrived on scene, um, I  
743 could see that they were trying to get physical control of his hands, try to get  
744 him to place his hands behind his back. They were unsuccessful, and I believe  
745 that the Taser prongs were still attached to the subject, and I ordered him  
746 again to get on the ground - to get on his stomach, so we could place him in  
747 handcuffs. He refused to comply, and I activated my Taser for a second time.  
748 Um, I broadcast to dispatch, just to keep them continually apprised to what  
749 was going on. That he was continuing - continuing to resist and I deployed my  
750 Taser a second time. Um, at this point he was on his back, laying on - on the  
751 roadway of El Camino Real. We were all, um, standing - standing around him  
752 almost in a circle waiting for him to - my initial plan was that - at some point  
753 he's going to roll over onto his stomach into a prone position and with enough  
754 people while he's placed in that position we'll be able to place his hands  
755 behind his back and handcuff him, because that was my top priority. Um, he  
756 refused to comply. I gave him more commands to roll over on his stomach. He  
757 was still very much agitated. He was speaking incoherently. He was moving,  
758 he was, um, very excited. And I deployed my Taser, um, for a third time.  
759 While I was still giving him commands to roll over on his stomach and I - I  
760 remember thinking I hope - I hope this is it - I hope this is the deployment - I  
761 hope he realizes that - that we can't just walk away. We can't walk away, we  
762 have to do something, and I hope that he would finally just give up and  
763 surrender and say, "I'm going to do what they were telling me to do and roll  
764 over on my stomach." But, um, he refused to do it again. I saw - I think it was  
765 deputy Bryan Watt grab his left arm and try to physically place his hand



766 behind his back. Um, he was trying to pull his arm away from Deputy Watt. I  
767 could tell that he was still resisting at this point. And so I believe I deployed  
768 my Taser a fourth time, and I notified dispatch. Um, he never gave any verbal  
769 in- indications that he would submit. Um, he never made any physical  
770 movements indicating to me that he was going to submit or comply with our  
771 instructions. Um, and I could just - I remember hearing multiple people telling  
772 him roll over. Get on your stomach - get on your stomach. He was eventually  
773 able to get himself to his feet on his own. He stood up and he began to run  
774 eastbound on El Camino towards the northbound lanes of traffic. And at that  
775 point, um, I thought that I - I thought that the Taser's been totally ineffective.  
776 Um, and there was no - and I am going to have to resort to another means of  
777 force in order to detain him. Um, as he was running across El Camino I  
778 transitioned to - I dropped my Taser. I transitioned to my baton. I - I expanded  
779 my baton and I got closer to him, and I kept telling him, "Get onto the ground.  
780 Get onto the ground." He never - again he never made any verbal indicators  
781 that he would comply. He never made any physical indicators that he would  
782 comply. Um, and at this point I started thinking, how - how are we going to be  
783 able to detain this guy? Um, he's - we've all seen - I've seen first-hand how -  
784 how physically strong he is. He wasn't - I never felt any point up until now or  
785 at any point during the whole incident that there was any window of  
786 opportunity to sort of engage in some like CIT training, or engage him in  
787 dialogue. He never really acknowledged who we were or acknowledged that,  
788 um, he may be open, um, to trying to work this out verbally. Um, so I  
789 expanded my baton. I told him to get on the ground. He refused to comply. I -  
790 I swung my baton, I was aiming for his knees, um, and I swung it with my  
791 right - I had the baton in my right hand. I swung it, um, swung the baton  
792 towards him. I missed, and at that point, I felt him tackle me after I missed. He  
793 had almost used the opportunity in which I was not facing him to grab onto  
794 me and kind of pull me to the ground. Um, while he did that, I saw something  
795 out of the corner of my eye, and I felt like a hot stinging pain on - on the left  
796 side of my face. Um, I didn't black out, but I knew something had hit me on  
797 the face. Um, and now he - now - at this point he was on the ground and I was  
798 on the ground. Um, I could feel that, uh, I felt that he was pulling on my duty  
799 belt. And I felt - I felt my waist and the bottom half of my body almost being  
800 pulled in one direction. And I didn't know what he was trying to do. Um, I  
801 had a friend who worked for the San Francisco Police Department who was  
802 physically over-powered in a similar situation, and, uh, my friend me told me  
803 that, you know, he thought he may have to shoot the person that was attacking  
804 him. And the thought came into my mind that, um, if he reaches for my gun I  
805 may be - I might be in a very bad situation in which, I'm on the ground and  
806 he's physically stronger than me. Um, I felt scared knowing that I couldn't - I  
807 couldn't stop him. I was trying as hard as I could to just get him to comply,  
808 and nothing I had done so far leading up to this had made him change his  
809 behavior or made him acknowledge my presence or - or the fact that he - he  
810 needed to listen to what we were telling him to do. Um, I - I - I tried to stand

811 up, and I know I struck him in the head - or I decided I was going to punch  
812 him. So stood up. I remember swinging my fist towards his head twice. And I  
813 - I remember the motion of swinging my fist, but I don't remember ever  
814 feeling anything coming into contact with my fist. And I don't - I wasn't sure  
815 if I actually hit him or I missed - or if I hit and through all the adrenaline, I  
816 didn't even realize that my hand, uh, even contacted him. That still didn't get  
817 him to comply, um, I was pulling on his arms trying to put his hands behind  
818 his back. I heard other - I know other deputies were nearby. They were trying  
819 to do the same thing. Um, and I still felt he was trying to resist, um, I wasn't  
820 sure if he was going to try and pull at my belt again. At that point I used my  
821 right hand, I reached down. I withdrew my, uh, OC spray. Um, I looked at  
822 him. I saw I had a clear view of his face, and I deployed a 1 second burst of,  
823 uh, OC spray to his face. Um, immediately upon deploying the OC, um, I  
824 heard other deputies scream in pain. I didn't hear him scream in pain, I didn't  
825 see any indication that he felt pain or discomfort as a result of that. Um, I felt  
826 some splash back into my face. Remember hearing someone say, "Stay in it.  
827 Stay in it." And I - I put my OC spray back into the holder. Um, and at some  
828 point, I - I - at some point I remember looking or standing up and seeing that  
829 he was handcuffed. And I don't - I don't know who placed him in handcuffs. I  
830 knew that they weren't my handcuffs that were on him. Um, in that he was  
831 now - his hands were restrained behind his back, but he was continuing - and  
832 he was on his stomach in a prone position and he was continuing to move - or  
833 writhe his body back and forth. And I remember still someone saying, "Stay  
834 on him - stay on him." And I thought that someone else observed that if we  
835 didn't try to hold him down that he was going to be able to get up again. So I -  
836 I was kneeling down, I was holding on - now I was on the left side of his  
837 body. I was holding his left arm down. Um, I heard other deputies saying that  
838 they had been pepper sprayed, and that they had felt the effects. And I  
839 thought, okay now that we had finally got him in handcuffs, but he's still  
840 continuing to move his body around. He's still so - so strong that we can't - I  
841 thought, you know, this is the best we can do. Just hold him until maybe more  
842 help arrived. Um, uh, I remember someone asking check for a pulse, make  
843 sure he's breathing. I started to but someone else - I saw someone else's hand  
844 go up to this, um, carotid artery. They said, "Yeah. He's still breathing. He's  
845 still fine." I heard him making noises, um, and so I - I took - I wasn't listening  
846 to radio traffic at that point, so I took - I decided I was going to make sure that  
847 medics were coming. Um, grant- seeing as how, um, I had Tased him, I had  
848 punched him, I had tried to hit him with my baton and I pepper - or OC  
849 sprayed him. Um, I wanted medics to get in there and make sure he was okay  
850 based upon all that force that we had just, um, affected on him. Um, dispatch  
851 told me medics were on the way. I remember looking up and to see if cars  
852 from - trying to proceed north on El Camino. I don't remember seeing any -  
853 any flashing red lights. Um, I was getting frustrated, um, I looked - I looked to  
854 my left at that point to look at southbound traffic. I remember not seeing any  
855 red lights or an ambulance, and I was - I was getting so frustrated because I

856 had thought I had requested an ambulance or medics right after I had Tased  
857 him, and it felt like a whole 5-10 minutes had gone by since - since then, and  
858 there were still no medics on scene. Um, at that point we rolled the subject  
859 over while he was handcuffed onto his side. Um, someone said check for a  
860 pulse again, someone checked they said he - he still - he still has a pulse. Um,  
861 we sat him up, um, we sat him up. I was using my left knee and another  
862 deputy was using their body or their knee to hold him upright. Um, other  
863 deputies were using water to flush out their eyes. Someone was passing out  
864 towels. Um, and someone told me, "Hey, Josh. Go sit down." And I sat - there  
865 was a - a pick-up truck. Uh, the tailgate was pulled down, so I sat down on the  
866 truck. Um, I was physically exhausted. I could - I couldn't even really speak.  
867 People were talking to me and I - I responded. I didn't know why, but my  
868 voice was just very low in volume. Um, and I just felt sort of a whole wave of  
869 emotions going through me like, um, like I was trying - trying to process  
870 everything that just happened. And - and, um, I went back to the person - or  
871 the subject. I think I helped hold him up a little bit longer. Um, I - everything  
872 else was kind of a whirlwind. I don't remember when the medics got there. I  
873 remember looking and seeing that they were doing CPR on him and I thought,  
874 that's not good. He - you know. If they're doing CPR on him he may - he may  
875 have lost his pulse and was in physical distress, and I started to think, um, I  
876 started to think if the medics had gotten there sooner, this wouldn't have  
877 happened. Um, and then someone told me, "Dude you're bleeding." And I  
878 didn't realize I was bleeding, and then I walked by a car on scene and I  
879 remember looking in the reflection. I remember seeing blood on the left side  
880 of my face. And I - I just thought I - I can't believe what just happened. I can't  
881 believe that - that this guy now needs CPR. I had gotten hurt and I was just  
882 sort of in disbelief about what had happened. Um, and then I went into -  
883 someone told - I went into an ambulance. Um, some people were saying get  
884 your picture taken. You need to have your picture taken. You need to go to the  
885 hospital. Um, so I went in the ambulance, and there was a lot of people trying  
886 to figure out what to do, and then I eventually - someone said take off your  
887 duty belt. Take off your uniform, you're gonna go to the hospital. So I did  
888 that. I gave it to Sergeant Trickett. The ambulance took me to the hospital,  
889 um, let me go back. Prior to leaving for the hospital someone asked what  
890 hospital are you taking him? Someone said Peninsula I think, and they said oh  
891 the - the subject's there. And they made it sound like I shouldn't go there, and  
892 I didn't quite understand why. Um, I didn't - I didn't quite understand why. I  
893 thought if he needs medical care, send him to the best hospital. If I need  
894 medical care, send me to the best hospital or the closest hospital. Just get - get  
895 me to the hospital, get him to the hospital. I don't - I don't see what the  
896 problem is. I don't know why we're kind of fussing over where we go. Um, so  
897 then I said, I don't have a problem with it. Just take - take me to the hospital.  
898 So then they took me to the hospital. Um, I went there, doctor said I needed  
899 some small stitches on my face. Told them about my injuries. Um, then at  
900 some point a bunch of Sheriff's Deputies and Sergeants came in. They just

901 said they just wanted to check on me, make sure I was doing, okay. Um, and  
902 then, uh, I was told that the DSA had gotten rooms at the Weston, and I  
903 wasn't sure why we would need to go to the Weston but, um, but my DSA rep  
904 drove me to the Weston. Met with the attorney's, um, my wife came. Talked -  
905 talked to people. They - they all asked if I was feeling okay. Um, and then that  
906 - that's when it really set in that - that - that person had - the subject had died.  
907 Um, no one at the hospital would tell me, um, so then it really set in that okay,  
908 this is a homicide. And so we kind of made arrangements about the scheduling  
909 and things like that. And then, uh, I went home and that was the conclusion of  
910 the incident.

911  
912 Q: Okay. Thank you. Okay. Uh, I know that was kind of involved for you. Do  
913 you need to take a break?

914  
915 A: I'm - I'm all right.

916  
917 Q: Okay. Just checking... Okay, so let me walk you back a little bit to the  
918 beginning and we'll gradually make our way through this. So you started  
919 saying you were in a marked patrol vehicle. You're in car 10 it's a Ford  
920 Explorer. In what way is it marked?

921  
922 A: It's, uh, painted black. The doors are painted white, um, it says Sheriff  
923 alongside - both sides of the car. Um, I think it's in reflective lettering too.  
924 Below that it says San Mateo County in black, block letters. Back of the car  
925 has a sheriff logo and says sheriff.

926  
927 Q: Okay.

928  
929 A: And it has, uh, emergency lights.

930  
931 Q: Okay. Now put me in your perspective. If I'm southbound on ECR coming to  
932 Millwood. Okay? And I'm looking out your windshield...

933  
934 A: Mm-hm.

935  
936 Q: Okay? Which direction out - if I'm you - or you want to show me and I'll  
937 mirror you. Which way do you see him first?

938  
939 A: So, um...

940  
941 Q: And don't worry about north or south...

942  
943 A: Okay.

944  
945 Q: ...just straight perspective.

946  
947 A: I saw him walking from my right to my left.  
948  
949 Q: Okay. So he's walking from your right to your left?  
950  
951 A: Right.  
952  
953 Q: Would you eventually at that moment get close enough to see his face, uh, in  
954 any way where you could, like, describe him?  
955  
956 A: No.  
957  
958 Q: Okay. Uh, at any moment do you recognize him from anything before this?  
959  
960 A: No.  
961  
962 Q: Okay. Do you remember any prior contact with him?  
963  
964 A: No.  
965  
966 Q: No? Remember seeing him on any alert, TRAK flier, anything?  
967  
968 A: No.  
969  
970 Q: Okay. So from this point of contact, you believe this is someone you've never  
971 had contact before?  
972  
973 A: Correct.  
974  
975 Q: Okay. Uh, have you since heard his name?  
976  
977 A: No.  
978  
979 Q: Okay. You said - so you see him, he goes from your right to your left...  
980  
981 A: Correct.  
982  
983 Q: And you said you pulled beside him. Okay what do you mean by that?  
984 Where's your car I relationship to him?  
985  
986 A: So I had - by that point now I was facing a - a red signal light, so I was  
987 stopped at - directly in the number one lane at the intersection of El Camino  
988 Real and Millwood, heading southbound.  
989  
990 Q: Mm-hm.

991  
992 A: He was now standing on the median that divides northbound and southbound  
993 El Camino.  
994  
995 Q: Okay. So you're at the red light, where is he in relationship to you?  
996  
997 A: To my left.  
998  
999 Q: Okay so he's right here?  
1000  
1001 A: Maybe not directly to my left, but maybe at my 7 o'clock - 8 o'clock position.  
1002  
1003 Q: Okay. So he's out - he's out your driver's side window?  
1004  
1005 A: Correct.  
1006  
1007 Q: Okay. How far away you think he is?  
1008  
1009 A: Uh, maybe 5 to 10 feet.  
1010  
1011 Q: Okay. So now you're waiting there to make a U-turn?  
1012  
1013 A: Correct.  
1014  
1015 Q: Okay. So you make a U-turn...  
1016  
1017 A: Correct.  
1018  
1019 Q: Now you're coming back. Do you remember what he does next, in terms of  
1020 what direction he goes next?  
1021  
1022 A: After I had made the U-turn he was walking on the sidewalk, northbound on  
1023 El Camino Real. And I positioned - I pulled my patrol vehicle over to the right  
1024 alongside the curb, so I could be alongside him.  
1025  
1026 Q: Okay. And this is after the U-turn?  
1027  
1028 A: Correct.  
1029  
1030 Q: Okay. It's at that moment in your statement you said, "I thought it was  
1031 something more." Explain to me - expand on that for me.  
1032  
1033 A: Uh, I didn't say I thought it was something more at that point. I rolled down  
1034 my window...  
1035

1036 Q: Okay.  
1037  
1038 A: And I told him, "Hey I have to talk to you for a minute." I wanted to make  
1039 verbal contact with him.  
1040  
1041 Q: Okay. What - what, if anything, does he indicate that he heard you or  
1042 recognize you or he - does he do anything to acknowledge your presence?  
1043  
1044 A: No.  
1045  
1046 Q: Okay. Does he make eye contact with you?  
1047  
1048 A: I don't remember.  
1049  
1050 Q: Okay. That's a perfectly good answer. Um - um, does he ever - when you're -  
1051 do you remember exactly order you gave him? Like I just need to talk to you.  
1052 Or did you give him any with you - as you would describe as a - a lawful  
1053 order that, you know, he's being detained?  
1054  
1055 A: I think - I think I said, "Hey stop. I got to talk to you."  
1056  
1057 Q: Okay. Are your lights on?  
1058  
1059 A: Yes.  
1060  
1061 Q: Okay. Um, and then - maybe that was when you start thinking this is  
1062 something more.  
1063  
1064 A: Right.  
1065  
1066 Q: Expand on that for me.  
1067  
1068 A: Um, based on the fact that he - he didn't make any acknowledgement that he  
1069 heard me or that he was going to comply...  
1070  
1071 Q: Mm-hm.  
1072  
1073 A: ...and he continued to walk. That's why I thought it might be something more.  
1074  
1075 Q: Okay. And what do you mean by that?  
1076  
1077 A: More than just a simple pedestrian stop.  
1078  
1079 Q: Okay.  
1080



- 1081 A: Where I pull alongside, I give them a command, I tell them to stop or they  
1082 stop. And then I exit my car and contact them.  
1083
- 1084 Q: Okay. What - what is your opinion of his demeanor at that point? Do you feel  
1085 like he's evading you? He's not paying attention? He didn't hear you? What  
1086 do you think's happening? If you had to speculate about his end of it.  
1087
- 1088 A: My speculation would be based on some prior experiences in which the same  
1089 thing has happened.  
1090
- 1091 Q: Mm-hm.  
1092
- 1093 A: Um, when I pull up alongside someone and tell them I need to talk to them -  
1094 in prior law enforcement experience, I've had people that continue walking  
1095 and they don't stop right away. And my - what I typically do is, I accelerate  
1096 my car rapidly and I pull up alongside the curb ahead of them, so I have time  
1097 to get out of the car and try and contact them in person, not from inside my  
1098 vehicle.  
1099
- 1100 Q: Okay.  
1101
- 1102 A: So that's what I tried to do with him when he continued to walk.  
1103
- 1104 Q: Okay. And what did he do that prevented that contact from happening?  
1105
- 1106 A: What...so I accelerated my car and I pulled up alongside the curb and I saw at  
1107 that point that he had walked from the - the sidewalk - the eastern sidewalk of  
1108 El Camino Real. Walked onto the lanes of traffic of El Camino Real. And now  
1109 he was walking on the median of El Camino.  
1110
- 1111 Q: Okay. And then I think it's that moment that you decided that, um, you were  
1112 gonna call for some more units.  
1113
- 1114 A: Correct.  
1115
- 1116 Q: Okay. And in to regards to that subject, what is it about his physical demeanor  
1117 that you - you flip a switch and realize, "I'm gonna need more units?"  
1118
- 1119 A: It - one it was based upon the fact that he was physically large in stature. That  
1120 was - that was one aspect. Two - the second was that he was holding multiple  
1121 bags in his possession. And I didn't know - I didn't know what was in the  
1122 bags. And three it was based upon the fact that he - in my opinion - at this  
1123 point he had made pre-indicators that he was gonna try and evade me.  
1124
- 1125 Q: Mm-hm.

1126  
1127 A: And not allow himself to be detained.  
1128  
1129 Q: Okay. Um, so then you describe how - I guess - I think you're in your car and  
1130 you see DeMartini and Lorenzatti, and now he's going towards them?  
1131  
1132 A: This was after I had conducted numerous U-turns and...  
1133  
1134 Q: Right - right.  
1135  
1136 A: ...was broadcasting...  
1137  
1138 Q: Right.  
1139  
1140 A: Yeah.  
1141  
1142 Q: So then you said he's going towards them.  
1143  
1144 A: Correct.  
1145  
1146 Q: Are they in their cars?  
1147  
1148 A: At this point I was driving southbound on El Camino.  
1149  
1150 Q: Okay.  
1151  
1152 A: I saw their - their marked patrol vehicles approach, with their lights and sirens  
1153 on. And I saw them stop their vehicles. I saw both of them exit their vehicles,  
1154 and I saw that he was continuing to walk towards them.  
1155  
1156 Q: Okay.  
1157  
1158 A: Um, and that's when I saw Deputy Lorenzatti motioning with her hands,  
1159 making quick motions with her hands. It almost looked like she was pointing  
1160 to the ground or pointing at him, like she was trying to emphasize what she  
1161 was telling him.  
1162  
1163 Q: Okay. As far as you can tell, is he looking at her?  
1164  
1165 A: Yes.  
1166  
1167 Q: Okay, in relationship to her. She's - she's out of her car, correct?  
1168  
1169 A: Correct.  
1170

1171 Q: Okay. Where's her car?  
1172  
1173 A: Um, her car was parked alongside - she was facing northbound in the  
1174 southbound lanes of traffic. So her car is facing the wrong direction...  
1175  
1176 Q: Mm-hm.  
1177  
1178 A: And her car was next to the sidewalk.  
1179  
1180 Q: Okay and his line of sight, can he see her and her car?  
1181  
1182 A: The subject?  
1183  
1184 Q: Yeah.  
1185  
1186 A: Yes.  
1187  
1188 Q: Okay. And you said her lights were on?  
1189  
1190 A: Correct.  
1191  
1192 Q: And - and, um, DeMartini's lights were on? Best you can recall.  
1193  
1194 A: I don't remember if his lights were on.  
1195  
1196 Q: Okay. And how far away are you when this interaction is happening?  
1197  
1198 A: Um, I would guess 30 - 30 feet?  
1199  
1200 Q: And it sounds like his back is to you?  
1201  
1202 A: Correct.  
1203  
1204 Q: Okay, can you see any physical acknowledgement on his part that he is  
1205 recognizing their presence?  
1206  
1207 A: No.  
1208  
1209 Q: Okay. Does he - he just keeps walking towards them?  
1210  
1211 A: Yes.  
1212  
1213 Q: Okay. Still with the bags in his hand?  
1214  
1215 A: Correct.

1216  
1217 Q: Okay. Um, and then - so then you said you got through some cars?  
1218  
1219 A: Correct.  
1220  
1221 Q: You get up there.  
1222  
1223 A: Yeah.  
1224  
1225 Q: Now you get out of your car.  
1226  
1227 A: Right.  
1228  
1229 Q: You make the decision, you're going to try to physically control him?  
1230  
1231 A: Correct.  
1232  
1233 Q: Okay. And you think you said you grabbed his right arm?  
1234  
1235 A: Correct.  
1236  
1237 Q: Okay. What if any orders are you giving him when you make that first  
1238 attempt?  
1239  
1240 A: I don't recall. My typical response is, put your hands behind your back.  
1241  
1242 Q: Okay. You made a comment that he - he easily over-came. Okay. Tell me  
1243 what you mean by that. Expand. What - what did he physically do?  
1244  
1245 A: So my intention was to grab his right wrist or arm and wrist and pull his right  
1246 wrist behind his back.  
1247  
1248 Q: Mm-hm.  
1249  
1250 A: When I say that he easily overcame that. I mean that he didn't allow me to  
1251 move his arm behind his back.  
1252  
1253 Q: What do you mean? What'd he do?  
1254  
1255 A: He - he pulled his arm away from my grasp. And I wasn't able to control his  
1256 arm.  
1257  
1258 Q: Okay. Are you - are you behind him?  
1259  
1260 A: I was...

1261  
1262 Q: Your chest towards his back?  
1263  
1264 A: No it was more my chest towards his right shoulder.  
1265  
1266 Q: Okay. And so you used one hand or both hands?  
1267  
1268 A: Both hands.  
1269  
1270 Q: Okay and what - what does he physically do? Does he pull against you? Does  
1271 he pull away from you?  
1272  
1273 A: He - he pulled against me. He pulled - he pulled his arm out of my grasp.  
1274  
1275 Q: Okay. And if you remember, as you do that. Where is - where is the other two  
1276 off- the two deputies?  
1277  
1278 A: I believe they were on the other side towards his left shoulder.  
1279  
1280 Q: Okay. So there - there - there's three of you there?  
1281  
1282 A: Correct.  
1283  
1284 Q: Okay. Is he saying anything?  
1285  
1286 A: Not that I recall.  
1287  
1288 Q: Okay. Are they giving any orders that you remember?  
1289  
1290 A: I heard yelling, but I don't know what they were saying.  
1291  
1292 Q: Okay. And you said you made a decision that you needed to handcuff the  
1293 subject.  
1294  
1295 A: I - I made that decision as soon as I saw them trying to physically restrain  
1296 him.  
1297  
1298 Q: Okay. So what - was that after you tried?  
1299  
1300 A: They - they tried to physically restrain him before I tried.  
1301  
1302 Q: Okay. So they - what - what - what did they do to try to physical restrain him?  
1303  
1304 A: I - they tried to grab his arms and...  
1305

1306 Q: Okay.  
1307  
1308 A: ...I presume...  
1309  
1310 Q: That's fine.  
1311  
1312 A: ...place his hands behind his back.  
1313  
1314 Q: Okay. And then shortly after that is when you try?  
1315  
1316 A: Correct.  
1317  
1318 Q: Okay. Um, and you - you make the decision you have to handcuff him. Okay  
1319 what - what is the nature or the reasoning behind handcuffing him?  
1320  
1321 A: I wanted to handcuff him because based upon my observations of him already  
1322 at this point, his behavior was unpredictable. He wouldn't acknowledge any of  
1323 my commands. He had already - like I said earlier, displayed pre-indications  
1324 that he was going to try and evade detention by - by creating distance between  
1325 myself and him. Um, and based on his physical stature, um, I thought in order  
1326 to prevent him from escaping and creating more distance between us. In order  
1327 to prevent him from attacking us, I felt much safer having him in handcuffs  
1328 before we tried to engage in any type of meaningful...  
1329  
1330 Q: Okay.  
1331  
1332 A: ...dialogue.  
1333  
1334 Q: So these two deputies are trying to control him. They're not able to. You try to  
1335 control him. Is he walking or standing still when that's happening?  
1336  
1337 A: He was standing still.  
1338  
1339 Q: Okay. And - and he's not - you don't remember him saying anything?  
1340  
1341 A: No.  
1342  
1343 Q: Okay. Um, do you remember any - other than the fact that he's clearly pulled  
1344 against you and resisted. Do you have any other physical, uh, signs that he's  
1345 aware of the presence of you and the other two deputies?  
1346  
1347 A: No.  
1348  
1349 Q: Okay. Um, and then you said, you could tell immediately, "I could not control  
1350 him"

1351  
1352 A: Correct.  
1353  
1354 Q: Okay. Expand on that please.  
1355  
1356 A: Just based on the ease in which he was able to pull from my grasp, um, I - I  
1357 based on that I thought, I'm not gonna be able to hold on to his arm. He's not  
1358 gonna allow me to place - I - would not be able to physically over power him  
1359 into placing his arm behind his back.  
1360  
1361 Q: Okay. Um, is it clear to you how much - it sounds like you're aware that's  
1362 he's bigger than you.  
1363  
1364 A: Correct.  
1365  
1366 Q: Is it clear to you - more clear when you get up close to him? Or did you know  
1367 all along?  
1368  
1369 A: I knew prior to physically contacting him how big he was. I radioed to  
1370 dispatch a description of him before I - before any other units had even arrived  
1371 on scene.  
1372  
1373 Q: Okay.  
1374  
1375 A: And I described him as, a 6 foot male, about 250 pounds.  
1376  
1377 Q: Okay. And you gave him an order or - a warning at least that you were going  
1378 to - you were going to tase him.  
1379  
1380 A: Correct.  
1381  
1382 Q: Okay. Do you see any physical reaction to that order?  
1383  
1384 A: No.  
1385  
1386 Q: Does he say anything?  
1387  
1388 A: Not that I recall.  
1389  
1390 Q: Okay. When you give that order. Is he looking at you or any of the other  
1391 deputies?  
1392  
1393 A: I don't know if he was looking at me, but he was facing me.  
1394  
1395 Q: Facing you?



1396  
1397 A: His body was directed towards me. I had a clear view of his chest.  
1398  
1399 Q: Okay so he - you don't remember where his gaze was, but you're face to face?  
1400  
1401 A: His body - right.  
1402  
1403 Q: And how far away are you?  
1404  
1405 A: I would approx- um, between myself and the door. So I would guess that's  
1406 about eight feet.  
1407  
1408 Q: Okay. When you give that warning, is he standing still or is he still walking?  
1409  
1410 A: I believe he was walking southbound on El Camino in traff- in the lane of  
1411 traffic.  
1412  
1413 Q: Okay. Uh, what are the dep- the other two deputies doing when he's doing  
1414 that and you're giving this order, if you remember?  
1415  
1416 A: I don't - I don't remember what they were doing.  
1417  
1418 Q: Okay. Um, and then you activate the Taser the first time.  
1419  
1420 A: Correct.  
1421  
1422 Q: And by that you mean you fire the probes.  
1423  
1424 A: Correct.  
1425  
1426 Q: Okay. What is his physical reaction to that?  
1427  
1428 A: His physical reaction was - I saw his body tense up, and I think he fell to the  
1429 ground.  
1430  
1431 Q: Okay. Do you remember seeing any visual confirmation of where the probes  
1432 if they both - if they both contacted or what your spread was at all?  
1433  
1434 A: No.  
1435  
1436 Q: Okay. Um, what model Taser do you have?  
1437  
1438 A: It's a X26.  
1439  
1440 Q: Okay. So my understanding is, you fire the probes the first time. It's a - it's a

1441 five second activation.  
1442  
1443 A: Correct.  
1444  
1445 Q: Okay. So - and it's not the model. It's the X26 original that has one set of  
1446 probes.  
1447  
1448 A: Correct.  
1449  
1450 Q: Okay.  
1451  
1452 A: Yeah.  
1453  
1454 Q: Do you carry a second set of probes on it?  
1455  
1456 A: No.  
1457  
1458 Q: Okay. Um, so then you said I could tell he was feeling discomfort.  
1459  
1460 A: Right.  
1461  
1462 Q: Tell me what that - what do you mean by that?  
1463  
1464 A: When I saw - when his body tensed up, I could tell that it was having some  
1465 type of effect on him.  
1466  
1467 Q: Okay and you - and you believe he fell to the ground?  
1468  
1469 A: I think so.  
1470  
1471 Q: Okay. Um, and then, uh, you said the - the deputies then tried to control him.  
1472  
1473 A: Correct.  
1474  
1475 Q: Okay. Then it sounds like there were some more officers coming at that point?  
1476  
1477 A: Correct.  
1478  
1479 Q: So what do you remember in your mind's eye - what were they doing to try to  
1480 control him after that first Taser activation?  
1481  
1482 A: They were trying to grab ahold of his arms.  
1483  
1484 Q: Okay. And what is he doing?  
1485

1486 A: Um, at this point, he was not allowing the other deputies to place his arms  
1487 behind his back.  
1488  
1489 Q: Okay. Like it looks like he's pulling against them?  
1490  
1491 A: Yes.  
1492  
1493 Q: Okay now. Leading up to the second time when you gave him orders - did you  
1494 give him orders before you activated the Taser a second time?  
1495  
1496 A: Yes.  
1497  
1498 Q: And by the second time you mean you're going to pull the trigger again on the  
1499 already deployed probes?  
1500  
1501 A: Correct.  
1502  
1503 Q: Okay. What I missed in there was did he get back up?  
1504  
1505 A: No.  
1506  
1507 Q: Okay. So he's down on the ground. He's physically resisting at least two  
1508 deputies.  
1509  
1510 A: Uh, yes.  
1511  
1512 Q: Okay. Do - do you remember giving another warning of any kind?  
1513  
1514 A: Yes.  
1515  
1516 Q: Okay. And what was that?  
1517  
1518 A: It was "get on your stomach now."  
1519  
1520 Q: Okay. Do you remember how many times you said it? Or if you said anything  
1521 else?  
1522  
1523 A: I don't - I know I said it at least three times. At least three or four times.  
1524  
1525 Q: Okay.  
1526  
1527 A: And I may have said, "Or you're going to get tased again."  
1528  
1529 Q: Okay. So you pull the trigger a second time.  
1530

1531 A: Correct.  
1532  
1533 Q: Okay. Now on the X26, once the Taser darts are deployed if you hold that  
1534 trigger - if you just pull it, it'll do five seconds. If you hold it - it will keep  
1535 going. Do you remember which one you did?  
1536  
1537 A: I pulled it and I released my finger.  
1538  
1539 Q: Okay. And was he...do you remember him being on the ground when that  
1540 happens?  
1541  
1542 A: Yes.  
1543  
1544 Q: Okay. What physical reaction do you recall to that second deployment?  
1545  
1546 A: Nothing.  
1547  
1548 Q: Nothing? Okay what's he - do you remember him doing anything? Does he  
1549 show any of the discomfort in that second deployment that he showed in the  
1550 first?  
1551  
1552 A: So - upon watching the MAV video...  
1553  
1554 Q: Okay.  
1555  
1556 A: ...so this isn't from my recollection. It's from watching the MAV video. He  
1557 says, "The word of God. Get them out of me."  
1558  
1559 Q: Do you have any conscious recollection for that second deployment if the  
1560 probes are still on his person or - or in a position to be effective?  
1561  
1562 A: No.  
1563  
1564 Q: Okay. But from that - from that - and I appreciate you clarifying. So you see  
1565 in the second one you deployed it. He says, you know, "Word of God get  
1566 them out of me." Um, and sitting here we don't know what he's referring to.  
1567 But you - you don't recall seeing a physical reaction in his demeanor that he's  
1568 reacting to that second deployment?  
1569  
1570 A: No.  
1571  
1572 Q: Okay. Um, So then you said you can see he's agitated, but he's speaking  
1573 incoherent.  
1574  
1575 A: Right.

1576  
1577 Q: So I take that to mean you can't understand what he's saying. But he's  
1578 agitated?  
1579  
1580 A: Right.  
1581  
1582 Q: Okay. Expand on that for me.  
1583  
1584 A: Um,  
1585  
1586 A: ...I could tell that he - he wasn't comfortable. He wasn't - he didn't want to  
1587 allow anyone to touch him or restrain him.  
1588  
1589 Q: Okay. I'm going to stop you. What do you mean? What - what - what - after  
1590 that second deployment are you or any of the deputies doing anything else to  
1591 physically control him?  
1592  
1593 A: Deputy Watt tried to grab his left arm and place it behind his back.  
1594  
1595 Q: Okay. Is he still on the ground? By that I mean the subject not Watt.  
1596  
1597 A: Yeah.  
1598  
1599 Q: Is he still on the ground after that second deployment?  
1600  
1601 A: I believe so, yes.  
1602  
1603 Q: Okay. And he's still physically resisting?  
1604  
1605 A: Correct.  
1606  
1607 Q: Okay, um, and - and you can tell he's agitated. Okay how would you - I know  
1608 it's not incoherent. But how would you describe his - a- a- audibly what is he  
1609 saying? What's it sound like?  
1610  
1611 A: At the time I didn't know what he was saying. Upon watching the video, now  
1612 I know he was saying, "Get them out of me. The word of God."  
1613  
1614 Q: Okay. Um, so now you're making the decision. You're going to be using the  
1615 Taser a third time.  
1616  
1617 A: Correct.  
1618  
1619 Q: Prior to that, do you have any confirmation yet, at that point, if the Tasers -  
1620 Tasers are still deployed and or on his person?

1621  
1622 A: I don't.  
1623  
1624 Q: No idea. Okay. Remember seeing your wires at all?  
1625  
1626 A: No.  
1627  
1628 Q: Okay. So prior to the third deployment, do you remember - approximately  
1629 how far away is he from you?  
1630  
1631 A: Um, I would guess maybe 6 to 8 feet.  
1632  
1633 Q: Okay. And is he still down on the ground?  
1634  
1635 A: Correct.  
1636  
1637 Q: Okay. Do you - did you give any kind of warning before the third use?  
1638  
1639 A: Yes.  
1640  
1641 Q: Okay and...  
1642  
1643 A: It was get on your stomach or you'll get tased again.  
1644  
1645 Q: Okay. And what is his body position on the ground just before that third one?  
1646  
1647 A: He's on his back.  
1648  
1649 Q: He's on his back?  
1650  
1651 A: Yeah.  
1652  
1653 Q: Okay. What's he - is - is - what's he - what's - what's - what's the motion of  
1654 his limbs if anything? What's he doing while he's on his back?  
1655  
1656 A: He's - he's moving.  
1657  
1658 Q: Mm-hm.  
1659  
1660 A: But I don't know if what - what his intentions were. It wasn't, uh, it wasn't a  
1661 motion in which I thought he might be trying to comply with my  
1662 instructions...  
1663  
1664 Q: Okay.  
1665

1666 A: ...and roll over on his stomach.  
1667  
1668 Q: Okay. So when you're making the decision that you might have to use this a  
1669 third time, is he doing something you recall with this limbs, that he's still  
1670 resisting those officers on scene and - and - and you? Do you remember is he  
1671 kicking anybody? Or is he flailing? What's he doing? If anything.  
1672  
1673 A: I think he was flailing.  
1674  
1675 Q: Okay. Um, so then you make the decision you're going to do the third  
1676 deployment. Okay? So you gave a similar warning?  
1677  
1678 A: Correct.  
1679  
1680 Q: Okay. And same thing. Did you pull and release?  
1681  
1682 A: Pull and release, yeah.  
1683  
1684 Q: Okay. What's his physical reaction to that?  
1685  
1686 A: I think he started getting up.  
1687  
1688 Q: He started getting up?  
1689  
1690 A: From the ground.  
1691  
1692 Q: Okay. So he's - he's under his own power?  
1693  
1694 A: Under his own power.  
1695  
1696 Q: No - no one's - no one's lifting him up. He's starting to get up.  
1697  
1698 A: Correct - correct.  
1699  
1700 Q: Is he getting up and - and don't - don't guess.  
1701  
1702 A: Right.  
1703  
1704 Q: Is he getting up during that 5 second activation? Or just shortly thereafter? Or  
1705 so close does it look like it's as he's getting up?  
1706  
1707 A: I couldn't tell if it was during the activation or if it was after.  
1708  
1709 Q: Okay. Do you see any of that - what you spoke of. That - that physical sign of  
1710 discomfort for that third activation?  
1710



1711  
1712 A: I don't remember.  
1713  
1714 Q: Okay. So he starts to get up. Does he get up?  
1715  
1716 A: Yes.  
1717  
1718 Q: Okay. In that part. Your mind's eye for there. Can you see your wires? Do you  
1719 see your wires anywhere? Do you have any idea if your probes are still  
1720 engaged?  
1721  
1722 A: I saw wires, but I couldn't see where they were attached to.  
1723  
1724 Q: Okay.  
1725  
1726 A: I saw wires from my gun - or the Taser...  
1727  
1728 Q: Right gun...  
1729  
1730 A: My Taser.  
1731  
1732 Q: I got you.  
1733  
1734 A: I saw copper wires and they were leading and there was just a clump of them  
1735 and I couldn't tell what they were attached to.  
1736  
1737 Q: Okay. Could you tell if they were still attached to him?  
1738  
1739 A: I could not.  
1740  
1741 Q: You could not. Okay. But he's not giving you any visual interpretation that  
1742 he's going to comply in anyway.  
1743  
1744 A: No.  
1745  
1746 Q: So he gets up.  
1747  
1748 A: Yes.  
1749  
1750 Q: Is he saying anything?  
1751  
1752 A: No.  
1753  
1754 Q: Okay. What's his demeanor as he's getting up?  
1755

1756 A: Uh, his demeanor was still uncompliant.  
1757  
1758 Q: And what do you mean by that?  
1759  
1760 A: Um, his body language never indicated to me that he was surrendering or  
1761 giving up.  
1762  
1763 Q: Okay. After the fourth - excuse me third time, he gets up. Deputies around  
1764 him. Is anyone trying to go hands on?  
1765  
1766 A: I believe Deputy Watt and Sergeant Weidner were trying to go hands on at  
1767 that point.  
1768  
1769 Q: Okay. Anybody else besides you or anyone any - stop that. Do you remember  
1770 at that point once he gets up, is there any more orders being given to him?  
1771  
1772 A: I don't remember.  
1773  
1774 Q: Okay. So now he gets up. You said he's not complying.  
1775  
1776 A: No.  
1777  
1778 Q: Okay. You think Watt and one other deputy tried to control him.  
1779  
1780 A: Correct.  
1781  
1782 Q: Do you re- do you remember seeing him resist that effort after that third  
1783 deployment?  
1784  
1785 A: I don't know if - yeah. I guess the short answer is yes, he resisted because I  
1786 never saw them place - I never saw them gain physical control over him.  
1787  
1788 Q: Okay. So at some point you make a decision now that he's back on his feet,  
1789 you're gonna try the Taser the fourth time?  
1790  
1791 A: Yes.  
1792  
1793 Q: Okay. So again, do you remember the distance he is away from you? At all?  
1794  
1795 A: I think he's starting to create distance between ourselves. And I think he's  
1796 starting to run eastbound on El Camino.  
1797  
1798 Q: Okay. and are the - the other deputies are they following?  
1799  
1800 A: They're following.

1801  
1802 Q: Okay. Do you remember them giving any orders or anything?  
1803  
1804 A: I remember they were yelling, but I don't know what they were saying.  
1805  
1806 Q: Okay. Um, so then, uh, you pulled the trigger a fourth- the trigger of your  
1807 Taser a fourth time.  
1808  
1809 A: I think so.  
1810  
1811 Q: I - I'll back up. In fairness, I remember you said, I think I used the Taser a 4th  
1812 time.  
1813  
1814 A: Right.  
1815  
1816 Q: And we'll figure that out later. But do you remember - have any recollection  
1817 of whether you pulled the - the - the trigger a fourth time? Or better yet, at that  
1818 moment you think you did, do you remember seeing a physical reaction to  
1819 him being under - under the influence of the Taser?  
1820  
1821 A: No.  
1822  
1823 Q: No.  
1824  
1825 A: And I'll add - this isn't from my recollection. It's from watching the video.  
1826  
1827 Q: Thank you.  
1828  
1829 A: As he's getting up and running, I hear the click - the distinctive noise of a  
1830 Taser and I hear someone saying, "Turn it off - turn it off."  
1831  
1832 Q: Okay.  
1833  
1834 A: Which makes me think that I did activate it a fourth time.  
1835  
1836 Q: Okay. Um, probably - do you believe - think it's another deputy saying turn it  
1837 off?  
1838  
1839 A: Yes. It - it wasn't me.  
1840  
1841 Q: Okay. That's fair. Do you remember turning it off?  
1842  
1843 A: I don't remember.  
1844  
1845 Q: Okay.

1846  
1847 A: I think I - after he had gotten up...  
1848  
1849 Q: Mm-hm.  
1850  
1851 A: Shortly after I had dropped the Taser.  
1852  
1853 Q: Okay. And that is when he's running eastbound?  
1854  
1855 A: Right. And I...  
1856  
1857 Q: Okay.  
1858  
1859 A: ...grab my baton with my left hand.  
1860  
1861 Q: Okay. And you made another statement - I'm going to make you expand  
1862 again. You said there was no indication that he was going to comply.  
1863  
1864 A: Right.  
1865  
1866 Q: Is that because he's running eastbound?  
1867  
1868 A: Correct.  
1869  
1870 Q: Okay. Is he saying anything?  
1871  
1872 A: I don't know.  
1873  
1874 Q: Okay. And do you remember if anything - orders that - that were being given  
1875 to him at that time?  
1876  
1877 A: I was yelling, "Get on the ground."  
1878  
1879 Q: Okay. And then you made a comment. You said, um - um, something about  
1880 you - you - you didn't have a chance yet to use your CIT training.  
1881  
1882 A: Yes.  
1883  
1884 Q: Okay. What - what - what is that training that you have?  
1885  
1886 A: So when I was at the San Francisco Police Department I took the, uh, crisis  
1887 intervention training...  
1888  
1889 Q: Mm-hm.  
1890

1891 A: Um, I completed the training, I got a certificate. Um...  
1892  
1893 Q: And what is - how - how - what does that entail?  
1894  
1895 A: It - it - it - I believe it's 40 hours or 80 hours, um, it's a whole - it's a  
1896 collection of different types of lectures and discussions and interactive  
1897 activities in which you learn more about people in crisis. More about people  
1898 with mental - mental disorders...  
1899  
1900 Q: Mm-hm.  
1901  
1902 A: Um, you sort of learn - it kind of teaches you to slow things down and not be  
1903 in such a rush to - to any course of action.  
1904  
1905 Q: Okay.  
1906  
1907 A: It kind of gets you to take a step back...  
1908  
1909 Q: Did that training include role playing?  
1910  
1911 A: Yes.  
1912  
1913 Q: Scenario based training?  
1914  
1915 A: Yes.  
1916  
1917 Q: Okay. You made that comment here sitting with me. Do you remember a  
1918 point in this interaction where you recognized this as being one those events if  
1919 at all?  
1920  
1921 A: No.  
1922  
1923 Q: Okay. And then, uh - uh, you said you swung your baton.  
1924  
1925 A: Correct.  
1926  
1927 Q: With you right hand I believe you demonstrated?  
1928  
1929 A: Right hand. Yeah.  
1930  
1931 Q: Okay. Did - you said you swung it one time?  
1932  
1933 A: Correct.  
1934  
1935 Q: Okay and you believe you missed?

1936  
1937 A: I know I missed.  
1938  
1939 Q: You know you missed. Okay. And so you swing - swang it...swang it? You  
1940 swung it at his legs?  
1941  
1942 A: Correct.  
1943  
1944 Q: Okay. One leg? Both legs?  
1945  
1946 A: Um, it - it was just towards the direction of his legs?  
1947  
1948 Q: Okay. And what was your justification to using the baton?  
1949  
1950 A: My justification was, um, prior - prior uses of force had been ineffective.  
1951  
1952 Q: Mm-hm.  
1953  
1954 A: His level of resistance had increased since the initial contact and - and was  
1955 escalating. Um, and I was still trying to effect a detention. At this point I was  
1956 trying to effect an arrest of the subject. And lower levels of force were  
1957 ineffective and I - and I believe I had to transition to another use of force.  
1958  
1959 Q: What - what - why did you still feel the necessity - the legal necessity to  
1960 control him, detain him, stop his behavior?  
1961  
1962 A: At this point he had committed multiple crimes that I - in my presence.  
1963  
1964 Q: And what were those?  
1965  
1966 A: Uh, he had resisted arrest. He had walked into the roadway. Um, there's you  
1967 know - he had violated the California vehicle code. He had resisted arrest.  
1968 Um, and at this point it became a concern of mine as to why he was resisting.  
1969 Why he was refusing to comply.  
1970  
1971 Q: Okay. Do you recall then making a determination he represented any kind of a  
1972 danger to anyone? Or you or the community?  
1973  
1974 A: Yes.  
1975  
1976 Q: Okay. Expand on that for me.  
1977  
1978 A: Um, him running in the roadway in the very beginning presented a danger to  
1979 himself.  
1980

1981 Q: Okay.  
1982  
1983 A: Um, a danger to the community. Um, and there were - in addition to  
1984 committing the crimes, you know - establishing his mental well-being was  
1985 also a factor. Um, whether or not he met the...maybe the criteria for mental  
1986 health detention.  
1987  
1988 Q: Okay.  
1989  
1990 A: Or required medical care - medical care for being in an altered state of mind.  
1991  
1992 Q: Okay. So - at risk of putting words in your mouth. At this point this is either  
1993 criminal or it could be a psychiatric emergency, but - in your mind - whatever  
1994 it is, there needs to be some physical detention of this subject?  
1995  
1996 A: Correct.  
1997  
1998 Q: Okay. Um and then, uh, you said you - you - sounds like you moved in at  
1999 some point you closed ground on him and then you felt something hit you. do  
2000 you have any idea what hit you?  
2001  
2002 A: I believe it was his hand.  
2003  
2004 Q: Okay.  
2005  
2006 A: It was after I had swung my baton and missed  
2007  
2008 Q: Right.  
2009  
2010 A: Right.  
2011  
2012 Q: How long after?  
2013  
2014 A: Immediately after.  
2015  
2016 Q: Immediately after. Okay. Now again, uh, what's your reaction to that? what  
2017 happened to you when that happened?  
2018  
2019 A: You - you mean like my - my physical reaction...  
2020  
2021 Q: Yeah.  
2022  
2023 A: ...or my state of mind?  
2024  
2025 Q: You recalled for me how you felt when you got punch.



2026  
2027 A: Right.  
2028  
2029 Q: Okay but what - did you stay on your feet?  
2030  
2031 A: I think I fell to the ground.  
2032  
2033 Q: Okay. And do you remember how you fell? Did you go backwards, face ...if  
2034 you know?  
2035  
2036 A: Um, I don't remember.  
2037  
2038 Q: Okay.  
2039  
2040 A: I remember just sort of feeling - feeling a force over my body. Pushing me in  
2041 some - some direction.  
2042  
2043 Q: Okay. You did make a comment. You said you stood up - so I'm assuming  
2044 that's - that's - you - you remember standing up as you go to punch him?  
2045  
2046 A: I remember the punches were from - he was below me when the punch - when  
2047 I punched him.  
2048  
2049 Q: Okay.  
2050  
2051 A: So I must have been in a position over him.  
2052  
2053 Q: Okay. And you said you thought you tried to punch him twice?  
2054  
2055 A: Yes.  
2056  
2057 Q: Was that with your...  
2058  
2059 A: Right hand.  
2060  
2061 Q: Right hand. Okay. But you're not sure if you hit him or not?  
2062  
2063 A: Correct.  
2064  
2065 Q: Okay. How does your hand feel today?  
2066  
2067 A: Feel's fine.  
2068  
2069 Q: Okay. So sitting her now, do you have any idea whether or not you made  
2070 contact or not?

2071  
2072 A: The fact that I don't feel any pain in my hand at all, makes me think that I - I  
2073 must not have connected with him.  
2074  
2075 Q: Okay.  
2076  
2077 A: I - I made the motions of punching, but...  
2078  
2079 Q: Do you remember what part of his body you targeted?  
2080  
2081 A: His face.  
2082  
2083 Q: Okay. And what was the nature of the justification for that?  
2084  
2085 A: At that point I had utilized physical control, which was ineffective in terms of  
2086 control holds. I utilized my Taser, which was ineffective. I utilized my baton,  
2087 which was ineffective. Partly because I missed, right? And at that point I  
2088 didn't - I didn't have any other force options to go to.  
2089  
2090 Q: When - when you made the decision that you were gonna use, um, try to strike  
2091 him. Do you remember knowing then - did you know that he had punched  
2092 you? Or that he had in some way assaulted you?  
2093  
2094 A: Yes.  
2095  
2096 Q: Okay. And tell me about your - your emotion- how you're feeling emotionally  
2097 right there.  
2098  
2099 A: I felt - at that point I had felt like all of his - his actions and his aggression and  
2100 his resistance was specifically towards me at that point.  
2101  
2102 Q: Okay.  
2103  
2104 A: I felt like he was targeting me. Um, and I - I felt a sense of hopelessness.  
2105  
2106 Q: Okay.  
2107  
2108 A: I felt that I - I was - I felt - I felt frustrated - I felt hopeless - I felt like I don't  
2109 know what I have to do to get him restrained. I don't know what I have to do  
2110 to take this guy into custody.  
2111  
2112 Q: Okay.  
2113  
2114 A: And I didn't know - I was worried. I didn't know how much longer this could  
2115 go on for. I had felt - you know right around - right after I had missed with the

2116 baton and he - he brought me to the ground. I started feeling the tugging on  
2117 my belt. I could feel - it - it just felt like hands were on...around my waist  
2118 line. And I felt...  
2119  
2120 Q: Could you tell what part of the belt he was tugging on?  
2121  
2122 A: I couldn't.  
2123  
2124 Q: Okay. And from the moment when you first used the Taser, until let's say the  
2125 moment you realize he's in handcuffs. Was there ever a time at all when you  
2126 were in fear for your safety?  
2127  
2128 A: Yes.  
2129  
2130 Q: Okay and what - describe that for me.  
2131  
2132 A: I was sort of describing it earlier. I - I felt like I couldn't - I couldn't stop him.  
2133 I felt like...  
2134  
2135 Q: So when you describe a sense of hopelessness it was that feeling...  
2136  
2137 A: Right. It was a sense of hopelessness. It was a sense of fear. It was a sense that  
2138 I - the thought - I mentioned earlier the thought crossed my mind of if - if he  
2139 keeps grabbing at my belt and I didn't know if he was grabbing at my gun.  
2140  
2141 Q: Okay.  
2142  
2143 A: And I...  
2144  
2145 Q: I - go ahead.  
2146  
2147 A: I didn't know he was grabbing at my gun. But I - I was thinking if - I was  
2148 getting really close to the point where I thought if he makes - if I see his hand  
2149 near my gun. Or I feel anything tugging at my gun, I'm going to shoot him.  
2150  
2151 Q: Okay. Do you know for sure it was him pulling on your belt?  
2152  
2153 A: I don't.  
2154  
2155 Q: Okay. And then you made a comment. You said, I still felt he was trying to  
2156 resist. So, um, and then it sounds like from the time you were whatever -  
2157 punched whatever - let's say you were punched. Let's assume you were  
2158 punched. Um, there's kind of a - it's cloudy. Right?  
2159  
2160 A: It is.

2161  
2162 Q: Okay so now I'm gonna fast forward to something when you're at the  
2163 hospital. What was the doctor's determination of what - if any injuries you  
2164 suffered from the punch?  
2165  
2166 A: They - the doctors asked if "were you punched or scratched?"  
2167  
2168 Q: Okay.  
2169  
2170 A: And I said, I don't know.  
2171  
2172 Q: Okay.  
2173  
2174 A: I said I know his hand was near my face. And I know that the singular attack  
2175 that I felt happened right after I swung my baton.  
2176  
2177 Q: Okay.  
2178  
2179 A: That's where I know it went from at most resisting to assaultive. Where he  
2180 actively picked me out of all the group of deputies and he came at me.  
2181  
2182 Q: Okay. Do you ever feel like now from the time you got punched - was there -  
2183 did it - did it have a change in terms of your mental perception of what was  
2184 going on?  
2185  
2186 A: A little bit.  
2187  
2188 Q: A little bit?  
2189  
2190 A: Yeah.  
2191  
2192 Q: Okay. Um, and then you said you - somehow you realized he's - he's  
2193 handcuffed, and you don't remember how that happened or who was able to  
2194 do it.  
2195  
2196 A: Right.  
2197  
2198 Q: But in your minds eyes you see that he's handcuffed.  
2199  
2200 A: Right.  
2201  
2202 Q: Um, and you said he's writhing back and forth. Explain that for me.  
2203  
2204 A: I remember he was still moving. Um, he was still moving his body around  
2205 while he was on his stomach. I remember hearing someone yelling, "stay on

2206 him - stay on him - stay on him - stay on him". And that made me think that  
2207 he's doing something that is still - that still requires us to maintain active  
2208 control over him. It's...

2209  
2210 Q: Okay.

2211  
2212 A: In - in that sense I thought that once the handcuffs went on, it wasn't like he  
2213 immediately surrendered.

2214  
2215 Q: Okay.

2216  
2217 A: Like he...

2218  
2219 Q: I think this is when you said you - you - you yourself were trying to hold his  
2220 left arm down.

2221  
2222 A: Correct.

2223  
2224 Q: And you made a comment like, "He's so strong."

2225  
2226 A: Right.

2227  
2228 Q: What do you mean?

2229  
2230 A: I remember thinking that - I mean even with his hands were strained, I was  
2231 trying to hold his arm down. I was on my knees. I remember thinking he's  
2232 mo- I - I know he's still moving and it's still requiring a lot of force just to  
2233 keep him in one spot.

2234  
2235 Q: Okay. When he's in the position, what position is his body in?

2236  
2237 A: So he's in the prone position.

2238  
2239 Q: By that meaning chest down?

2240  
2241 A: Chest down. Yeah.

2242  
2243 Q: Okay. Was he still talking or making noise audibly?

2244  
2245 A: I don't recall.

2246  
2247 Q: Okay. But is he still physically resisting you and anybody else that has their  
2248 hands on him?

2249  
2250 A: Yes.

2251  
2252 Q: Okay. And you don't remember if he's saying anything or anything like that?  
2253  
2254 A: No.  
2255  
2256 Q: Okay. Was anything - do you recall any moment in there where his breathing  
2257 was restricted?  
2258  
2259 A: No.  
2260  
2261 Q: Okay. Do you remember - and obviously we're going to take statements from  
2262 them. Do you remember witnessing any other efforts or use of force  
2263 techniques by the other deputies to control him? Besides grabbing the arms...  
2264  
2265 A: Af- af- after that point? After he was handcuffed?  
2266  
2267 Q: From - from - from first Tasing to, now he's in handcuffs and he's still  
2268 fighting against you. Anything else other than what you describe? Grabbing  
2269 for arms. Do you remember any other techniques that were used?  
2270  
2271 A: I believe Deputy Lorenzatti had her baton out at one point.  
2272  
2273 Q: Okay.  
2274  
2275 A: I don't know if she's uti- utilized it or struck him with it.  
2276  
2277 Q: Okay. Do you remember anyone else using any other control holds of any  
2278 kind? Or at least trying?  
2279  
2280 A: Yes. I don't know which specific control hold they were trying to utilize, but I  
2281 know they were actively holding onto the subject.  
2282  
2283 Q: And - and what part of his body?  
2284  
2285 A: His arms - his hands.  
2286  
2287 Q: Okay. Do you remember any - anything, um, in terms for like, the neck up?  
2288 Do you remember anybody trying a carotid restraint? A head lock...  
2289  
2290 A: No.  
2291  
2292 Q: ...anything like that?  
2293  
2294 A: No.  
2295

2296 Q: Okay. Do you remember if anyone had any contact with his throat? Neck?  
2297

2298 A: I didn't see anyone have contact with his neck or throat. I don't know if they  
2299 attempted to or not.  
2300

2301 Q: Okay. But you don't remember anybody trying anything like...  
2302

2303 A: Neither myself, nor any other deputy had any hand near his face or his neck.  
2304 Other - other than why I tried to punch him twice.  
2305

2306 Q: So that you - right. So the physical use - in terms of use of force from if you  
2307 look at the escalation...  
2308

2309 A: Mm-hm.  
2310

2311 Q: What you remember is there was hands on. Trying to grab and control arms.  
2312 Um, you remember trying to control his legs at any point?  
2313

2314 A: I didn't see that. No.  
2315

2316 Q: Okay. And then, uh, you said when he's down on the ground, when he's chest  
2317 down this is when you realize, you know, how strong he is and he's making  
2318 noises. What do you mean?  
2319

2320 A: I heard him breathing.  
2321

2322 Q: Okay.  
2323

2324 A: Um...  
2325

2326 Q: Do you remember seeing if his eyes were open or closed?  
2327

2328 A: At one point his eyes were open.  
2329

2330 Q: Okay. In that - in that same moment?  
2331

2332 A: Correct.  
2333

2334 Q: Okay. And then you make the decision that you're going to sit him up?  
2335

2336 A: Correct.  
2337

2338 Q: Okay. How many deputies - were you a part of the deputies that help him sit  
2339 up?  
2340



2341 A: I think so.  
2342  
2343 Q: Okay. Do you remember feeling him using any of his own strength or power  
2344 to sit himself up? Do you remember him participating in the process at all?  
2345  
2346 A: Just due to how heavy he was I - I don't know.  
2347  
2348 Q: Okay. So, but it sounds like he was able to sit up.  
2349  
2350 A: We...  
2351  
2352 Q: Or you got him sit - sat...  
2353  
2354 A: Well, yeah. At one point he was sitting up.  
2355  
2356 Q: Okay.  
2357  
2358 A: His - his butt was on the ground...  
2359  
2360 Q: Okay.  
2361  
2362 A: His - his back and legs were at a 90 degree angle. Um...  
2363  
2364 Q: Leg's straight out? Knees bent? What do you remember?  
2365  
2366 A: I don't - I don't remember.  
2367  
2368 Q: Okay. How about torso? Was he up straight? Leaning over?  
2369  
2370 A: Um, he was - I was having to use my left leg, and there was another deputy. I  
2371 don't - I don't remember who.  
2372  
2373 Q: Okay. Is - is you left leg like on his back?  
2374  
2375 A: So - so my...  
2376  
2377 Q: Are you holding him up?  
2378  
2379 A: ...foot is - the heel of my foot is on the ground. I'm using my shin and my  
2380 knee to keep him upright.  
2381  
2382 Q: Okay.  
2383  
2384 A: I could feel his weight leaning against my - my leg.  
2385

2386 Q: Okay so do you - now I want you to go back. Do you remember the moment  
2387 for right here when he's leaning against your back and he's sitting up?  
2388

2389 A: Yes.  
2390

2391 Q: Okay do you remember hearing him breathing? Do you remember hearing  
2392 him making noises?  
2393

2394 A: I didn't hear him breathing. I didn't hear him making noises. I know someone  
2395 said check for a pulse. And I know someone said he's still breathing.  
2396

2397 Q: Okay. When he's on your knee, okay? Is he slumped over or is he sitting up?  
2398 Do you know whether or not he's using any of his core strength to sit up?  
2399

2400 A: I - I don't know.  
2401

2402 Q: Okay. And when you're using you knee is it - is his momentum back towards  
2403 you?  
2404

2405 A: Yes.  
2406

2407 Q: Okay.  
2408

2409 A: And that's typical. I - I don't think I've ever come across someone that can be  
2410 handcuffed with their hands behind their backs, sit on their butt and keep  
2411 themselves up right...  
2412

2413 Q: Okay.  
2414

2415 A: ...without needing some kind of support for their back.  
2416

2417 Q: Do you remember seeing his face at that time at all?  
2418

2419 A: No.  
2420

2421 Q: Okay. Do you remember him moving his head in any way?  
2422

2423 A: I don't remember.  
2424

2425 Q: Okay. And by that you mean you don't remember if he was or not?  
2426

2427 A: Right.  
2428

2429 Q: He was not.  
2430

2431 A: Right.  
2432  
2433 Q: Okay. Um, and then at some point how did you go from holding him up and  
2434 someone told you, "Hey you need to go sit down?"  
2435  
2436 A: Yeah.  
2437  
2438 Q: And you go sit on the tailgate?  
2439  
2440 A: Yeah.  
2441  
2442 Q: And you said it's kind of hazy at this point?  
2443  
2444 A: Right.  
2445  
2446 Q: Do - do you have any guess how long you're sitting on that tailgate?  
2447  
2448 A: No.  
2449  
2450 Q: Okay.  
2451  
2452 A: No.  
2453  
2454 Q: But at some point, you got off the tailgate, and you realize medics have started  
2455 CPR?  
2456  
2457 A: Correct.  
2458  
2459 Q: Okay. You don't remember seeing that process start? It's just all the sudden  
2460 that's what's going on?  
2461  
2462 A: Yeah.  
2463  
2464 Q: Okay. How are you feeling when you're on the tailgate?  
2465  
2466 A: When I first sat down I felt light-headed. I felt - I felt like the energy had been  
2467 drained out of me. I - I wasn't - I was mentally trying to process everything  
2468 that had just happened. Um, the more - the more I try and remember specific  
2469 details...  
2470  
2471 Q: Mm-hm.  
2472  
2473 A: ...when I recalling the more I realized there was - it - it's so hard to remember  
2474 what happened.  
2475

2476 Q: Okay.  
2477  
2478 A: And I - I don't even know if I saw it with my own eyes. My brain didn't  
2479 process it or...  
2480  
2481 Q: Okay.  
2482  
2483 A: ...or...  
2484  
2485 Q: And I'm gonna back you up to just when he's sitting up.  
2486  
2487 A: Mm-hm.  
2488  
2489 Q: Is anybody talkin' to him?  
2490  
2491 A: I don't - I don't recall anyone talkin' to him.  
2492  
2493 Q: Okay. You don't remember if he was talking or not or?  
2494  
2495 A: No.  
2496  
2497 Q: Okay. Um, do you remember anything else that any of the deputies are doing?  
2498 As far as like, you know, what's going to be after actions. What's coming  
2499 next?  
2500  
2501 A: Like...  
2502  
2503 Q: You - you mentioned that, um, uh, you couldn't believe medics were takin' so  
2504 long.  
2505  
2506 A: Right.  
2507  
2508 Q: So, uh, were they - do you remember any discussion on that? Was there any  
2509 discussion whether they were gonna speed them up? If you remember?  
2510  
2511 A: I remember asking for them more than once. I remember saying - I remember  
2512 asking for them. I remember dispatch saying they've already been called.  
2513 They're in route. And then - I was getting frustrated. I know I asked for them  
2514 a second time and I don't - I don't even remember what dispatch said when  
2515 they - they came back.  
2516  
2517 Q: Okay. Um, all right that was a long uninterrupted. I'm going to let you take a  
2518 break.  
2519  
2520 A: Okay.

2521  
2522 Q: Drink some water. You're welcome to step outside of course. And then I'm  
2523 gonna go confer, make a few notes...  
2524  
2525 A: Okay.  
2526  
2527 Q: And then we'll walk back through a couple more things...  
2528  
2529 A: Sure.  
2530  
2531 Q: Hopefully it won't be too much longer, okay?  
2532  
2533 A: Thank you.  
2534  
2535 Q: All right. I'm going to leave this here.  
2536  
2537 A: Okay.  
2538  
2539 Q: Remember this is being recorded if you need to step out and talk to your  
2540 council.  
2541  
2542 A: Sure. All right.  
2543  
2544 Q1: I'm going to step out of the room real quick.  
2545  
2546 A: Sure. Do you want - can I go with you?  
2547  
2548 Q1: Yeah, sure come on.  
2549  
2550 A: Okay. Cool.  
2551  
2552 Q1: Yeah, please do.  
2553  
2554 A: All right.  
2555  
2556 A: Yeah. Okay. Should I sign this now?  
2557  
2558 Q1: Yeah, go ahead and take a look at it. Those are instructions on how to fill it  
2559 out.  
2560  
2561 A: Okay.  
2562  
2563 Q1: It's pretty straight forward but use my pen here.  
2564  
2565 A: For purpose of requested use and disclosure of the records it says check -

2566 check yours. I'm sure they'll fill it out for whatever they want it for. Right?  
2567  
2568 Q1: Well you can put it for criminal investigation...  
2569  
2570 A: Investigation?  
2571  
2572 Q1: ...or something like that. That's fine.  
2573  
2574 A: These are instructions for electronic.  
2575  
2576 Q1: Mm-hm.  
2577  
2578 A: I hereby (unintelligible).  
2579  
2580 Q: You need a few more minutes?  
2581  
2582 A: Um...  
2583  
2584 Q: I can step out.  
2585  
2586 Q1: No. he's just fillin' this out.  
2587  
2588 A: Do - do - do - do you just want me to release the records to the DA's office?  
2589  
2590 Q: Yeah, that's fine. That's fine.  
2591  
2592 A: Okay.  
2593  
2594 Q1: If you're okay with it.  
2595  
2596 A: Yeah.  
2597  
2598 Q1: All right. We figured we'd just take a second to fill this out.  
2599  
2600 Q: No problem go ahead. I'm - I'm - we can go back on though, whenever you're  
2601 ready.  
2602  
2603 Q1: Yeah I'm gonna...  
2604  
2605 Q: Okay. Um, just a few things...  
2606  
2607 A: Sure.  
2608  
2609 Q: ...and then we'll - so obviously I can see the mark on your face. What - what -  
2610 today - what - what injuries - what - what sense of pain do you have as far as

2611 your whole body?  
2612  
2613 A: Um, my right knee has a scratch. It's pretty stiff. It's kind of sore.  
2614  
2615 Q: Okay.  
2616  
2617 A: Um, my neck is sore. Hurts turning my head left and right. Um, my face hurts  
2618 a little bit. Um, my wrist - my right wrist hurts. Um, that's about it.  
2619  
2620 Q: Okay. Um, and how were you - were you able to sleep last night?  
2621  
2622 A: Yeah.  
2623  
2624 Q: Okay. How long were you treated at the hospital if you remember?  
2625  
2626 A: One hour maybe?  
2627  
2628 Q: And I appreciate you during the interview clarifying what you saw verse what  
2629 you remember, but so I understand, um, prior to the interview and obviously  
2630 with your councilor you - you saw your own MAV video. Um, and then, um,  
2631 uh, you were able to view some photos that were taken with a civilian's cell  
2632 phone. Ah, excuse me... video taken, but the audio was taken out, right?  
2633  
2634 A: Right.  
2635  
2636 Q: And I'm telling you that because I took the audio out, but...  
2637  
2638 A: Okay.  
2639  
2640 Q: Did you view any other videos beside that?  
2641  
2642 A: Um, no.  
2643  
2644 Q: Okay. and other then since it happened. Um, other than your council have you  
2645 talked about it with anybody else or discussed it with anybody else?  
2646  
2647 A: No. Um, well I told my wife just generally what happened, just so...  
2648  
2649 Q: Okay. Um, and I - I - I asked you several times, but now just take a minute.  
2650 From what you remember from first contact to, let's say when you were no  
2651 longer helping him sit up and you look over and CPR started. Do you  
2652 specifically remember anything he said? Anything he asked? Anything he  
2653 verbally responded to?  
2654  
2655 A: Other than the statements I saw from the statements I saw from the video...



2656  
2657 Q: Right.  
2658  
2659 A: ...The word of God take these out. Um, no.  
2660  
2661 Q: Do you remember him having any, you know, reciprocal conversation? Any  
2662 two-way conversation with anybody?  
2663  
2664 A: No.  
2665  
2666 Q: Okay. Um, and then, uh, for prior you said you had the prior CIT training?  
2667  
2668 A: Correct.  
2669  
2670 Q: Um, you made a comment about how you never had a chance - and I think  
2671 that's because how fast this evolved, but has there been prior instances where  
2672 your CI - CIT training you were able to de-escalate a situation?  
2673  
2674 A: Yes - yes.  
2675  
2676 Q: Okay just give me. Just summarize one of those for me.  
2677  
2678 A: Uh, this happened within the last month. We went to a call of a - a - I think  
2679 she's schizophrenic or bi-polar or maybe both. Um, a girl who attacked her  
2680 mom. Threw a chair at her, um, I went there I was the primary unit and - you  
2681 know, I eventually talked to her for, you know, and extended period of time. I  
2682 tried to form connections with her. Let her know I didn't want to hurt her. I  
2683 wasn't trying to get her in trouble. And we eventually got her to, uh, we  
2684 placed her in a mental health detention without any force or anything like that.  
2685 And she cooperated.  
2686  
2687 Q: Okay. And that was from your verbal interaction with her?  
2688  
2689 A: Specifically, my verbal interaction with her.  
2690  
2691 Q: Okay. And I - I - I know for a fact you didn't have a Taser in San Francisco.  
2692  
2693 A: Correct.  
2694  
2695 Q: Um, but I assume you've carried a Taser since you came to the Sheriff's  
2696 office?  
2697  
2698 A: No.  
2699  
2700 Q: No?

2701  
2702 A: Um...  
2703  
2704 Q: How long have you had the Taser? How long have you been certified or  
2705 qualified with carrying the Taser?  
2706  
2707 A: I want to say it's probably been about - probably about a month.  
2708  
2709 Q: Probably about a month?  
2710  
2711 A: Yeah.  
2712  
2713 Q: And then what was the process to get to where you're allowed to carry it?  
2714  
2715 A: Uh, I took training through the Sheriff's Office.  
2716  
2717 Q: Okay.  
2718  
2719 A: Uh, it was taught by a Deputy who I think - I think took training from Taser.  
2720  
2721 Q: Okay.  
2722  
2723 A: Um...  
2724  
2725 Q: Do you remember how long the training was?  
2726  
2727 A: It was a day.  
2728  
2729 Q: Okay. Was that, uh, was there some like class room about how it works? That  
2730 kind of thing?  
2731  
2732 A: There's a classroom about how it works...  
2733  
2734 Q: 'Kay.  
2735  
2736 A: ...and then there was a practical application where you shot like a little target.  
2737  
2738 Q: Right. The big foil thing?  
2739  
2740 A: Right.  
2741  
2742 Q: Okay. Did you have any scenario-based training at all?  
2743  
2744 A: Uh, no.  
2745

- 2746 Q: Okay. Any - any video where you watched other incidents or anything  
2747 involving a Taser?  
2748
- 2749 A: Yes.  
2750
- 2751 Q: Okay. I assume you went through, like, the precautions of the device and that  
2752 kind of thing.  
2753
- 2754 A: Right.  
2755
- 2756 Q: Okay. Um, after you got - we think you got punched. It's safe to say the  
2757 subject did something to strike you in the face. Is that...Okay? Uh, and you  
2758 said you - you felt the hot - the heat on your face. Do you remember feel dizzy  
2759 or dazed? How - how was your feeling internally in terms of where your head  
2760 was at?  
2761
- 2762 A: I thought I was - I felt pain on my face. I thought I was fine. And sitting here  
2763 trying to recap all the events, I - I'm sort of - it - it's becoming clear to me that  
2764 a lot of things that happened that I'm not aware of.  
2765
- 2766 Q: Right.  
2767
- 2768 A: And I don't know if it's because it happened, and my brain didn't process it.  
2769 Or if I didn't see it. My attention was directed elsewhere.  
2770
- 2771 Q: Okay.  
2772
- 2773 A: Um...  
2774
- 2775 Q: I mean, I'm not puttin' words in your mouth, but you - sounds like you are  
2776 starting to see that there may be some gaps in your recollection since...  
2777
- 2778 A: Yes.  
2779
- 2780 Q: ...from after the time you got punched?  
2781
- 2782 A: Yes.  
2783
- 2784 Q: Okay. Um, and then, uh - uh, what other training have you have had beside  
2785 CIT? Have you had verbal judo? Tactical communications? Anything like  
2786 that?  
2787
- 2788 A: Yeah, I mean everything they teach in the POST academy. Um, uh...  
2789
- 2790 Q: Any specialized training since after you got out of the academy?

2791  
2792 A: Uh, in continuing CPT kind of stuff. Continuing professional training, I think.  
2793 I've taken a block of tactical communication.  
2794  
2795 Q: Okay.  
2796  
2797 A: Um...  
2798  
2799 Q: When you were an FTO in San Francisco were you ever in charge of teaching  
2800 that to others?  
2801  
2802 A: No.  
2803  
2804 Q: No? Um, ever - ever had to teach anything as far as CIT related to one of your  
2805 trainees or anything like that?  
2806  
2807 A: Not - not - not in an official setting.  
2808  
2809 Q: Right. But...  
2810  
2811 A: But yeah.  
2812  
2813 Q: But critique after a call that kind of thing?  
2814  
2815 A: Right. Yeah.  
2816  
2817 Q: Okay. So I'm going to ask you a big generalized question you don't have to  
2818 jump at the answer. Take a minute. Based on everything we've talked about  
2819 over several minutes.  
2820  
2821 A: Mm-hm.  
2822  
2823 Q: Anything about this that you didn't have a chance to talk about that you  
2824 thought about now that you haven't discussed? I didn't ask the right question,  
2825 anything you want to correct or change or interject? Just take a minute to think  
2826 about that.  
2827  
2828 A: It's not something that you can answer.  
2829  
2830 Q: Mm-hm.  
2831  
2832 A: But it's just what's going on in my head. I just - I can't figure out why this  
2833 happened. I don't - I don't know why he did that. I don't know anything about  
2834 him. I've never seen him before. I've never had any prior contacts with him. I  
2835 don't - I don't know if he did it because - I just - I just - I just don't know why

2836 - why it went to the shitter so quickly.

2837

2838 Q: Mm-hm.

2839

2840 A: And why - why it turned out like this.

2841

2842 Q: Okay.

2843

2844 A: I - I have thought about how it could have turned out differently. Um, if - if  
2845 we had more units, we could have blocked off traffic and just kind of corralled  
2846 him. And even if he wanted to pace back and forth, we could try and establish  
2847 some kind of dialogue. You know? And actually, try to use CIT kind of...

2848

2849 Q: Mm-hm.

2850

2851 A: ...techniques. But he - he never. There was no communication between - at  
2852 least that I saw between myself and him. There was no - it - it would be easier  
2853 for me to understand if - if he said, when I said, "Hey man, let me talk to  
2854 you." If he said, "Hey fuck you."

2855

2856 Q: Right.

2857

2858 A: It - it would be more. I - I could comprehend that a little bit more. Then I  
2859 know, okay. You have some problems - you have a problem with law  
2860 enforcement which may be warranted. You know, and I've had that happen  
2861 before and sometimes we - we work it out. I - I let people know, you know I  
2862 understand you may have had bad experiences with law enforcement. But I,  
2863 you know, give everybody a chance. I'm not - I - I don't know. I'm just kind  
2864 of spit ballin' here.

2865

2866 Q: I understand.

2867

2868 A: But I - I don't know why. There was - there was no communication. There  
2869 was no - there was nothing that he gave me that I could read off of to figure  
2870 out, you know, how - how can we do this without any force?

2871

2872 Q: Okay.

2873

2874 A: You know? Um, maybe we could have, like I said, corralled him and created -  
2875 in San Francisco it's time and distance. You know that's - that's the big thing  
2876 up there. Um, I kind of try to do that here where I just - I use the term over the  
2877 radio "paralleling him". I wasn't trying to force his hand or anything. I was  
2878 just circling around trying to get more - more resources there to - to make this  
2879 work. You know?

2880

2881 Q: Mm-hm.  
2882  
2883 A: And I didn't mention this earlier, but I don't remember doing this. But from  
2884 the video I remember at one point prior to other units getting there I got out of  
2885 the car - I got out of the car multiple times. And I thought maybe this is the  
2886 chance where he'll stop, and I can talk to him. And then he kept walking, so I  
2887 think I got out of the car two or three times. Got out and then he would just  
2888 walk about, and I would think, "Oh, shit. I have to get back in the car." During  
2889 one of the times when he's on the median, my biggest fear in that situation -  
2890 or one of my biggest fears is getting his by a car because I can't see the car  
2891 comin'. Drivers are terrible, right? He's gonna get hit by a car or I was gonna  
2892 hit by a car. So my biggest fear was getting' hit by a car. And I remember  
2893 after I watched the video, I - I got out of the car and I said, "Hey, man. Let's  
2894 go talk on the side walk." You know?  
2895  
2896 Q: Mm-hm.  
2897  
2898 A: "Talk to me. Tell me how much you hate cops. I'll listen." You know?  
2899  
2900 Q: Mm-hm.  
2901  
2902 A: Just - just tell me somethin'. Don't - don't just walk away and, you know, I  
2903 don't know. There - I think there would have been a different outcome.  
2904  
2905 Q: Okay.  
2906  
2907 A: But, um...  
2908  
2909 Q: Sir, do you have anything you'd like to clarify?  
2910  
2911 Q1: No I have no questions.  
2912  
2913 Q: Okay. Just give me two seconds, I'll come back, and I'll tell you what  
2914 happens from here and then you're all done. All right?  
2915  
2916 A: All right.  
2917  
2918 Q: Okay. All right so, um, uh, were you able to finish that?  
2919  
2920 A: Uh, not yet.  
2921  
2922 Q: I'll leave you time to finish that. All right so what happens now is this is the  
2923 part you will not be used to from San Francisco County. So any investigation  
2924 we call an OICI, it's an officer involved critical incident. That would include  
2925 an officer involved shooting, something like this. Uh, this would be in custody

2926 death. Uh, we make it a point to complete the investigation from start to finish  
2927 in 8 weeks.  
2928

2929 A: Okay.

2930

2931 Q: Um, I know that's not - that's not the San Francisco policy...  
2932

2933 A: That's - that's unheard of.  
2934

2935 Q1: It's extremely atypical - yeah.  
2936

2937 Q: So we - we will be done in eight weeks. And from that - I mean the final  
2938 report binders will go onto Mister Wagstaffe's desk. Um, he will review  
2939 everything -and he will literally review everything, watch everything and, um,  
2940 then we'll have a meeting where everybody, uh, basically contributes. Then  
2941 make a determination. An then at that time, typically what happens is he will  
2942 issue a letter to your agency.  
2943

2944 A: Okay.  
2945

2946 Q: Now in that eight weeks, it is very possible that your agency will make the  
2947 decision independent to the DA's office to let you return to work. Um, I  
2948 would advise you to return to work when you're ready to go to work.  
2949

2950 A: Okay.  
2951

2952 Q: Um, and - and from personal experience and having been on administrative  
2953 leave before from a critical incident. You go back to work when you're ready.  
2954 We will have no bearing on that.  
2955

2956 A: Okay.  
2957

2958 Q: Your agency will make that determination, and they may tell you - you are  
2959 free to go back. But again, I'll tell you on a personal level, you go back when  
2960 you're ready to go back. That may be before that eight weeks is up.  
2961

2962 A: Okay.  
2963

2964 Q: So when final determination is made, you may have already been back on  
2965 patrol for, you know, X number of days. So, but it will be completed in 8  
2966 weeks. Um, if you wake up tomorrow - which it's gonna happen. And you -  
2967 maybe you remember other things or things start to come back or more  
2968 details, um speak to him. It may not be - you may feel like it's something you  
2969 need to pass on to us right away, you may talk to him and he's going to tell  
2970 you it's - it's fine. Okay? But if there is something critical you remember that

2971 you feel the need, we can certainly sit back down and do it. Okay?  
2972  
2973 A: All right.  
2974  
2975 Q: But again, my advice is to go through him and see if it's really that critical.  
2976 Okay?  
2977  
2978 A: All right.  
2979  
2980 Q: Um, obviously if you wouldn't mind completing that today.  
2981  
2982 A: Yeah - yeah.  
2983  
2984 Q: You know, we just use that as part of the investigation.  
2985  
2986 A: Okay.  
2987  
2988 Q: We're not going into your whole medical history.  
2989  
2990 A: Okay.  
2991  
2992 Q: Um, and the other thing we'll do it we will go to, um the Sheriff's Office. We  
2993 review the backgrounds and training...  
2994  
2995 A: Okay.  
2996  
2997 Q: ...of everyone that's involved. You included. Um, we look at your  
2998 professional background. I don't look at whether you like walks on the beach.  
2999 I just look at your background for the time you're an officer. We look at, um -  
3000 um, accommodations, anything that's in your file. We look at your training to  
3001 confirm that - that's -that will all be a part of it.  
3002  
3003 A: Okay.  
3004  
3005 Q: Um, but I don't want you to think we go diving in. So in your file there will be  
3006 a letter signed by us saying that we looked at your file.  
3007  
3008 A: Okay.  
3009  
3010 Q: That's to make sure it's all part of everything in the package that we give to  
3011 Mister Wagstaffe.  
3012  
3013 A: Okay.  
3014  
3015 Q: We do the same for the decedent.



3016  
3017 A: Okay.  
3018  
3019 Q: We do a full background on him including criminal history, prior contacts.  
3020 That's all - that's all part of the report.  
3021  
3022 A: Okay.  
3023  
3024 Q: Um, and then you'll have access to all that once it's done, we typically make  
3025 two copies of it. Uh, it's usually one or more 3-inch binders. Um, that includes  
3026 all the DVDs and everything and then the major report is a master summary  
3027 report. It's usually about 40 or 50 pages. But it will all be made available to  
3028 you and your agency.  
3029  
3030 A: Okay.  
3031  
3032 Q: Once it's complete there is no part of our investigation that will be not to your  
3033 purview that you can't look at it.  
3034  
3035 A: Okay.  
3036  
3037 Q: And then you know once it's done. We will then sometimes create a third one  
3038 where we redact a lot of stuff like personal information so that it's open...  
3039  
3040 A: Public Record.  
3041  
3042 Q: ...public record. The press can look at it.  
3043  
3044 A: Okay.  
3045  
3046 Q: And then, uh, you know chances are the press is going to get your name.  
3047 Chances are they're going to publish it. I'm just telling you that up front.  
3048  
3049 A: Okay.  
3050  
3051 Q: It's not something you or us, or your department can prevent. Okay? It's just  
3052 the nature of the business now so...  
3053  
3054 Q1: Un- un- unless there's specific threats to your safety.  
3055  
3056 A: Okay.  
3057  
3058 Q1: In which case give me a call immediately.  
3059  
3060 A: Okay.

3061  
3062 Q: Yes, and you need to articulate that to him, before that - that's the case.  
3063  
3064 A: Okay.  
3065  
3066 Q: Okay?  
3067  
3068 Q1: That's, you know, death threats on - if you have social media. I mean,  
3069 unfortunately it happens.  
3070  
3071 A: Okay.  
3072  
3073 Q1: Especially in this day and age. And so I mean, my advice is to shut down any  
3074 social media you have, but if - if for some reason you're getting and it sounds  
3075 like they know who you are and you know - and - and know where you live.  
3076 That kind of thing, and your family. Let us know immediately.  
3077  
3078 A: Okay.  
3079  
3080 Q: Okay?  
3081  
3082 Q1: Okay.  
3083  
3084 Q: Do you have any other questions or anything?  
3085  
3086 A: Nope.  
3087  
3088 Q: All right. All right. Thanks.  
3089  
3090 A: Thank you I appreciate it.  
3091  
3092 Q1: Thank you.  
3093  
3094 Q: Sorry to meet on these circumstances, but...  
3095  
3096 Q1: I'll let you finish that up, then I'll - is Alyssa here?  
3097  
3098 A: I think someone said she's outside.  
3099  
3100 Q1: Okay. Let me go talk to her real quick. Okay?  
3101



**SUMMARY:**

On October 5<sup>th</sup>, 2018, at approximately 1:50 PM, I met with Community Service Office (CSO) Joseph Gonzales and Sergeant Daniel Guiney San Mateo County Sheriff's Office. The purpose of the meeting was to obtain a statement from CSO Gonzales about the incident in Millbrae on October 3<sup>rd</sup>, 2018. CSO Gonzales had requested Sergeant Guiney (one of his supervisors) to be present with him in the interview. I explained that the interview was recorded and that we only wanted to obtain a statement from CSO Gonzales if it a non-compelled statement that was freely and voluntarily. CSO Gonzales stated that he understood and confirmed that no one had told him he needed to provide a statement to us.

**BACKGROUND:**

Joseph Gonzales stated that he is employed by the San Mateo County Sheriff's Office as a Community Service Officer (CSO). He has been a CSO in the city of Millbrae for just over two years. He graduated from a local high school in San Mateo County and has taken a few classes at the College of San Mateo. He explained that his day-to-day duties include parking enforcement, traffic control, handling abandoned vehicles and the intake of property. He sometimes assists with vehicle accident reports. His normal work days are Monday, Tuesday and Wednesday and his normal shift runs from 7:00 AM to 5:00 PM.

Gonzales explained that he generally wears a uniform for his work and confirmed he was wearing his uniform during this incident. He described the uniform he was wearing as a light blue San Mateo County Sheriff's Office shirt, navy blue color cargo style pants, a black duty belt and black boots. He confirmed that his uniform shirt has Sheriff's Office shoulder patches, and a "Community Service Officer" badge (#13) and name tag on his chest.

Gonzales reported that his duty-belt was equipped with the following items: keys, police radio, latex glove holder, OC spray (pepper spray), a tourniquet, Narcan and a digital recorder. When questioned more specifically, Gonzales confirmed that he did not carry a firearm, Taser, baton, asp, or handcuffs. *(Gonzales later told me after the interview that he carries his digital recorder to in case he needs to obtain a statement in an accident investigation but confirmed he never activated his recorder during this incident.)* Gonzales told me that he received no specific training or certifications related to arrest control tactics or his carrying of OC spray. He confirmed that he has received in-house training that is directly related to his daily duties.

Gonzales drives an assigned vehicle when he works. On this particular day he was driving Vehicle #15 which is a Ford F150 pick-up truck. The truck is equipped with emergency lights to assist with traffic control.

**STATEMENT OF INCIDENT:**

Gonzales confirmed that he began his shift at 7:00 AM. He started his shift by handling some parking complaints and a vehicle that needed to be towed. He confirmed that there was nothing that had happened that was out of the ordinary or emotionally charged.

**CONTROLLED DOCUMENT**

Prepared By: 80208 MAHER, RICH	Date: 10/12/2018	Approved By: 80240 WARREN, JOHN	Date: 12/17/2018
-----------------------------------	---------------------	------------------------------------	---------------------



Gonzales first became aware of the incident as he was finishing his “covering” duties for the records technician. He described hearing an initial radio call from Deputy Wang requesting another officer and then hearing the situation has changed to a “Code-3” call for assistance. Gonzales explained that since the call originated as a “person running through traffic on El Camino” he felt that he might be needed to block traffic and/or re-route traffic with his assigned vehicle. He left the station in his vehicle and traveled, what he estimates to be four to five blocks, to the scene. He traveled north on El Camino Real and stopped his vehicle in the northbound lanes near the scene. From his stopped position, he could see the team of deputies in the #1 and #2 southbound lanes of El Camino Real. He identified the team of deputies as Bryan Watt, Alyssa Lorenzatti, Josh Wang and Sergeant Dave Weidner.

Gonzales activated his emergency lights and repositioned his vehicle at an angle to try and block the northbound left turn lane and the northbound #1 and #2 lanes of El Camino Real.

Gonzales described still being seated in his vehicle and seeing the group of deputies as it moved towards his location in pursuit of the man. He remembered that the deputies were yelling at the man to stop as they proceeded after him over the center median. He could not remember exactly what was being yelled, but it was clear they were trying to get the man to stop. Gonzales described the man as being a large black man, with scuff on his face, and wearing a blue shirt. He estimated the man was over 6’ tall and between 240 to 250 lbs.

Gonzales looked to his right side briefly (to see if there were any vehicles on the right side of his vehicle) and when he looked back he saw that the group had tripped or fallen to the ground near the left rear of his vehicle. He was unsure how they ended up on the ground but the entire team was on the ground struggling with the man. Gonzales decided the group might need his help to control the man so he exited the truck and joined the group. Gonzales grabbed the man’s right arm and hand. In an effort to keep the man from hitting the officers he held the arm as securely to his own chest as he could. (NOTE: Gonzales demonstrated this in the interview by grabbing his own hands together and pushing them up against his chest.) He could not remember the specifics of what was being said at this moment but he remembered that deputies were repeatedly telling the man to stop resisting and to put his hands behind his back.

Gonzales was unsure if someone on the team deployed pepper spray (OC spray) but several of the involved deputies backed away from the man while still trying to get him under control. Gonzales saw that some of the deputies were suffering from pepper spray but he didn’t see anyone deploy it and he did not get the spray on him in the incident. Gonzales confirmed that he did not deploy his own spray in this incident.

Deputy Watt, who suffered from exposure to the pepper spray, handed Gonzales an extra pair of handcuffs. Gonzales was intending to hand off the extra handcuffs and help put them on the struggling

**CONTROLLED DOCUMENT**

Prepared By: 80208 MAHER, RICH	Date: 10/12/2018	Approved By: 80240 WARREN, JOHN	Date: 12/17/2018
-----------------------------------	---------------------	------------------------------------	---------------------



**CONTROLLED DOCUMENT**

man but the other officers were successful in getting the man handcuffed without his assistance. Gonzales is not sure who actually handcuffed the man.

Gonzales explained that once the man was handcuffed, they sat him up on his rear end. Someone asked for water to rinse the pepper spray from their eyes. Gonzales didn't have any water in his truck, so he walked over to a nearby dentist office and they supplied him with bottled water.

Gonzales clarified that when he left the immediate area of the scene, to search for water, the man was sitting upright but "out of it." He elaborated that the man was conscious, awake, breathing and looking around. He described in more detail that the man was seated, with his legs out in front of him, while leaning back against the legs of two deputies who were standing directly behind the man. He confirmed the two deputies were using their legs to provide the man with something to lean against but he could not remember exactly which two deputies were standing behind the man.

Gonzales estimated that he returned to the immediate scene about one minute later with the water. Gonzales heard someone request medics, which had been staged nearby, and he confirmed the man was still seated upright when he returned. Gonzales qualified that while he saw the man was seated upright upon his return, he did not notice if the man was still conscious.

Medics were called in to help. Gonzales thought that the medics has been called into the scene because of the pepper spray exposure and because one of the deputies had suffered a significant cut on his face.

Gonzales then approached Sergeant Weidner and asked him what else needed to be done. Sergeant Weidner asked him to stop traffic and redirect the passing vehicles with better traffic control. He explained that once traffic control was properly established he stepped back out of the way and acted as a "rover" by checking in with various deputies to see if they needed anything.

I asked Gonzales when he first realized there was "something wrong" with the man. He told me that he never really realized there was anything wrong. He explained that when anyone is tased the medics are called to check them out, so he didn't think there was anything significant about the medics being involved.

When asked about the man being transported in an ambulance, Gonzales acknowledged that the fire department personnel were "working" on the man (administering chest compression) as he was being transported to the ambulance. Gonzales added that he thought the man was alright once he had been placed on the ambulance.

Gonzales stated that once the patients (Decedent Chinedu Okobi and Deputy Josh Wang) were transported the remaining personnel cleared the area, put up crime scene tape and established a perimeter with a scene log.

<b>Prepared By:</b> 80208 MAHER, RICH	<b>Date:</b> 10/12/2018	<b>Approved By:</b> 80240 WARREN, JOHN	<b>Date:</b> 12/17/2018
--	----------------------------	---	----------------------------





**CONTROLLED DOCUMENT**

When asked, Gonzales confirmed he did not see the man get tased but he did notice a taser prong and taser wires when he was restraining the man’s hand and arm. He thought the prong might have been in the man’s right arm or in the right side of his chest.

When asked why he exited his truck and got involved in this incident Gonzales stated, “It was a just a reaction. I saw that the team was struggling, um, I saw that they were not able to apprehend him and I saw that his right hand was flailing.” He confirmed that he feared the team would not be able to establish control over the man. He described the man flailing his right arm and hand at Deputy Wang who was grabbing him around the body. The blows delivered by the man to Deputy Wang were both open hand and closed hand. He explained that the man was “fighting” with five people and the five people were not able to stop him. Gonzales said that people were out on the street watching and traffic was still moving; he didn’t know what might happen if the man got up and continued down the street.

Gonzales confirmed that the only physical involvement he had with the man was when he restrained the man’s hand and arm before he was handcuffed. Gonzales also confirmed that he didn’t deliver any blows or strikes, didn’t use pepper spray, didn’t use a taser (even someone else’s taser) against the man. Gonzales told me that he is trained as a second degree black-belt martial arts instructor. When asked specifically, he confirmed that he did not apply any martial arts techniques on the man.

Gonzales estimated that six to seven minutes elapsed from the time that he arrived on the scene to the time that the man was handcuffed.

Gonzales reported that he suffered no injuries in the incident. He remarked that he did get some of the man’s blood on his shoulder, pants and forearm. He was unsure if the man’s chest was bleeding but he thinks came into contact with the blood when he restrained the man’s arm up against his chest.

**OVERHEAD PHOTO:**

Gonzales was shown an overhead photo of the scene. They photo had been taken with a camera mounted on a drone and was taken after the decedent had been transported and a crime scene had been established. He marked the overhead photo in the described manner:

- Circled the location of his assigned vehicle (VEH #15)
- in the location where he first saw the group of officers struggling with the man
- in the location where he saw the group of offices pursuing the man in the roadway
- in the location where the man and the officers went to the ground and where he became involved by temporarily restraining the man’s right arm

When he had completed marking the photo he signed the bottom left edge.

Prepared By: 80208 MAHER, RICH	Date: 10/12/2018	Approved By: 80240 WARREN, JOHN	Date: 12/17/2018
-----------------------------------	---------------------	------------------------------------	---------------------



At the conclusion of the interview I encouraged Gonzales to re-contact me if he remembered anything new or if he thought there was something we failed to cover.

**DISPOSITION:**

Attach to Original Report

**CONTROLLED DOCUMENT**

Prepared By:

80208 MAHER, RICH

Date:

10/12/2018

Approved By:

80240 WARREN, JOHN

Date:

12/17/2018



**SAN MATEO COUNTY DISTRICT ATTORNEY'S OFFICE**

400 COUNTY CENTER, 3RD FLOOR REDWOOD CITY, CA 94063 650-363-4636

**SUPPLEMENT 14 - Initial Statements Obtained by  
SMCO SO Deputies/ W's Barboza and Neily**

**Investigation:**

At the scene of the incident on October 3, 2018, San Mateo County Sheriff's Office personnel turned over three pages of handwritten notes on yellow paper to San Mateo County District Attorney's Office Inspectors who had arrived on scene to investigate the incident. The handwritten notes appeared to be initial statements taken by San Mateo County Sheriff's Deputies from Witnesses Dennis Barboza and Paul Neily.

Both Dennis Barboza and Paul Neily were re-interviewed in detail. Dennis Barboza was interviewed by Menlo Park Police Detective Josh Russell (Officer Involved Critical Incident Team Member) on October 3, 2018 and Paul Neily was interviewed by District Attorney Inspector Eric Suzuki on October 5, 2018.

San Mateo County Sheriff's Office Sergeant Irfan Zaidi confirmed that Deputy John Demartini obtained some initial statements at the scene and Dennis Barboza and Paul Neily were two of those witnesses. Due to the fact that Deputy Demartini was one of the Deputies who was involved in the critical incident, no supplemental report was generated by him to memorialize the statements. Sergeant Zaidi also confirmed that Deputy Demartini did not record either of the interviews he conducted with Dennis Barboza and Paul Neily.

Seeing that both witness have been re-interviewed in detail by members of the San Mateo County District Attorney's Office and/or by members of the Officer Involved Critical Incident Team, I have attached copies of the handwritten notes to this supplemental report. (The pdf copy of the handwritten notes are 6 pages in length, simply to show that the back side of each page was blank). (Please refer to attachment entitled- Initial SMCO SO Witness Statements).

**Disposition:**

Attach to Original Report

**CONTROLLED DOCUMENT**

Prepared By:  
80202 MASSEY, BILL

Date:  
10/16/2018

Approved By:  
80240 WARREN, JOHN

Date:  
12/18/2018





**Supplemental Report to Case #18-1003-02:**

On October 5, 2018, I returned the following uniform items and equipment to San Mateo County Sheriff's Office Professional Standards Sergeant Jon Sebring:

**Items from Deputy Joshua Wang:**

- Pants
- Underbelt
- Boots

The District Attorney's Office retained Deputy Wang's X26P Taser (Serial #X13004A6P) and collapsible baton, which had been collected at the incident scene by members of the San Mateo County Crime Laboratory.

(SMCO DA's Office Bureau Case #18-1003-02, Evidence Item's #5 and 14.)

(Please refer to the separate supplemental report in which I detailed the chain of custody and collection of Deputy Wang's duty belt, firearm and related equipment.)

**Items from Deputy Alyssa Lorenzatti:**

- Short sleeve shirt with badge, pens, nametag, etc.
- Pants with underbelt
- Complete duty belt, gun holster with Glock 19 9mm, serial #BDVY911, collapsible baton and holder, (2) magazines in holder, belt keepers, flashlight in holder, radio holder, taser holster, double cuff case, misc. keys.
- Boots
- Inner ballistic vest

The District Attorney's Office retained Deputy Lorenzatti's X26P Taser (Serial #X13004AD5). (SMCO DA's Office Bureau Case #18-1003-02, Evidence Item #6.)

**Items from Sergeant David Weidner:**

- Short sleeve shirt
- Pants with underbelt
- Duty belt with firearm, Smith and Wesson MP 9mm, serial #NAU4296 with taclight, taser holster, keys and keepers
- Boots
- Outer ballistic vest with badge, nametag, radio, (3) primary magazines, collapsible baton, MAV audio antenna, handcuffs, and secondary firearm (Smith and Wesson M&P Shield 9mm, serial #HYV9207).

The District Attorney's Office retained Sergeant Weidner's X26P Taser (Serial #X13001W86).

**CONTROLLED DOCUMENT**

Prepared By: 80202 MASSEY, BILL	Date: 10/16/2018	Approved By: 80240 WARREN, JOHN	Date: 12/18/2018
------------------------------------	---------------------	------------------------------------	---------------------



(SMCO DA's Office Bureau Case #18-1003-02, Evidence Item #7.)

I personally took 5 additional detailed digital photographs of Sergeant Weidner's taser.  
(SMCO DA's Office Bureau Case #18-1003-02, Evidence Item #4.)

**Items from Deputy Bryan Watt:**

Short sleeve shirt

Pants with underbelt

Baseball cap

Duty belt with primary firearm, Smith and Wesson MP 45, serial #HUK3982 in holster, double cuff case, keys, keepers and taser holster

Boots

Outer ballistic vest with badge, nametag, radio, (2) magazines, Kershaw knife, collapsible baton, pepper spray, handcuffs, secondary firearm (Smith and Wesson MP Bodyguard 380, serial #KDY1688), and (2) secondary firearm magazines.

The District Attorney's Office retained Deputy Watt's X26 Taser (Serial #X00-380563).  
(SMCO DA's Office Bureau Case #18-1003-02, Evidence Item #23.)

**Items from Deputy John Demartini:**

Short sleeve shirt with badge, pens, nametag, etc.

Pants with underbelt

Complete duty belt with keepers, (2) primary firearm magazines, primary firearm, Smith and Wesson MP 9mm, serial# HUR3012 with holster, collapsible baton with holder, taser holster, key keeper and handcuff case

Inner ballistic vest

Boots

The District Attorney's Office retained Deputy Demartini's X26 Taser (Serial #X00-564295).  
(SMCO DA's Office Bureau Case #18-1003-02, Evidence Item #24.)

**End of supplemental report.**

**CONTROLLED DOCUMENT**

Prepared By:  
80202 MASSEY, BILL

Date:  
10/16/2018

Approved By:  
80240 WARREN, JOHN

Date:  
12/18/2018



**Investigation:**

On 10/3/2018, at approximately 1415 hours, I responded to the intersection of El Camino Real and Millwood in the city of Millbrae to assist with an officer involved critical incident involving deputies from the San Mateo County Sheriff's Office. Upon my arrival, I was requested to respond to the Westin San Francisco Airport Hotel located at a 1 Old Bayshore Hwy in Millbrae for the purpose of collecting the uniforms and equipment of the involved Sheriff's Office personnel.

Upon my arrival at the hotel, I made contact with Sheriff's Deputy and DSA (Deputy Sheriff's Association) President DJ Wozniak. Wozniak told me that the involved deputies were sequestered in individual rooms and each was accompanied by a peer support representative. He also stated that photographs of the deputies and sergeant while in full uniform were already completed by a Sheriff's Office detective. I subsequently responded to each of the rooms and collected uniforms from the following persons:

- Deputy Bryan Watt
- Deputy Alyssa Lorenzatti
- Deputy John DeMartini
- Deputy Joshua Wang
- Sergeant David Weidner

I collected the full uniform and duty belts from all of the above listed personnel with the exception of Deputy Wang. Deputy Wang told me that his shirt, ballistic vest, and duty belt with equipment was previously taken for the purpose of preserving its condition by Sheriff's Office Sergeant Szerenyi.

I placed the each of the complete uniforms into separate large paper bags and I transported the bags to the San Mateo County District Attorney's Office to secure them. I later photographed each of the uniforms and I provided the photographs to Inspector Draper for inclusion with the case file.

**Disposition:**

Attach to Original Report

**CONTROLLED DOCUMENT**



**Investigation:**

**Statement of Witness Emil Cafferata:**

Witness Emil Cafferata had contacted the Millbrae Substation for the San Mateo County Sheriff's Office on or around October 16, 2018. San Mateo County Sheriff's Office Sergeant Dan Guiney contacted me and asked that a member of the San Mateo County District Attorney's Office contact Cafferata, as he indicated that he may have information regarding the Millbrae incident from October 3, 2018. District Attorney Inspector Eric Suzuki attempted to contact Cafferata on October 17<sup>th</sup> and 18<sup>th</sup>, but he was unable to leave a message on Mr. Cafferata's cell phone. Inspector Suzuki was off duty on Friday October 19, 2018 and I was alerted that Mr. Cafferata wished to speak with someone regarding the incident, so I called and left a voicemail message on his cell phone. It should be noted that the voicemail greeting was a female with a name of Renee and the phone was able to accept a voicemail message on October 19<sup>th</sup>, which had been unsuccessful for Inspector Suzuki on October 17<sup>th</sup> and 18<sup>th</sup>.

On October 19, 2018 at approximately 1545 hours, Emil Cafferata called my office phone and provided a statement. I recorded the phone call via a digital recorder connected to my office phone. The following is a summary of my conversation with Emil Cafferata:

Emil Cafferata stated that he previously "encountered the black guy who was stunned and died." Cafferata said that he left a couple of messages with the Sheriff's Office and also with the San Jose Mercury News. I asked Cafferata to tell me what information he had regarding the incident.

Cafferata said that he and his wife returned from Hawaii approximately three or so weeks ago and they were "doing their usual walk on Broadway Street" in downtown Millbrae. Cafferata identified a jewelry store on Broadway that he first believed to Millbrae Jewelers, but then later clarified that it was Numis International, one block south. Cafferata said that he and his wife were walking northbound on Broadway when he saw "a black guy coming on the other side of the street." Cafferata stated that what caught his eye was that the subject began walking down the middle of the street, towards him and his wife. Cafferata said that the subject had a little boy with him (ultimately estimated to be approximately five years old) and the subject wasn't holding the boy's hand. Cafferata said that the young child "could barely keep up" with the subject.

Cafferata stated that the subject "was making like a beehive towards me" and Cafferata was concerned for the young child whom he believed was with the subject, specifically fearing that the child may get hit by a car. Cafferata said that the subject began yelling in front of him and his wife, "White people keep calling the police on us black folk" and Cafferata said that "black folk struck me as, maybe southern, you don't hear that around here too often and he said it several times as he passed us." Cafferata stated that the subject didn't bump into them, but then he added, "I looked him in the eye and he wasn't looking at me, he was looking into space kind of." Cafferata said that as he got about twenty feet behind them, he (Cafferata) responded by saying, "Yeah, but I've never called the police on anybody."

**CONTROLLED DOCUMENT**

Prepared By:  
80202 MASSEY, BILL

Date:  
10/20/2018

Approved By:  
80240 WARREN, JOHN

Date:  
12/18/2018





Cafferata stated that the subject turned around and faced him and said, "That don't matter" and he said that twice. Cafferata said that the subject wasn't making eye contact with him and he felt that he was "looking out into space."

Cafferata stated that the subject then crossed the street back over to the opposite side of the street, so Cafferata had the impression that the subject had crossed the street simply to make the statement to him (Cafferata). Cafferata said that the subject crossed in the middle of the street and he thought that he might have been headed back to BART, which is in close proximity to downtown Millbrae. Cafferata stated that the subject and the boy were both well dressed and he said the subject was clean cut and didn't look like "a street person." Cafferata thought about calling the police at that time, but he formed the opinion that the subject had not really done anything wrong, so he decided not to.

Cafferata stated that several days later, he heard about an incident in Millbrae and he read an article in the Mercury News and believed the subject mentioned in the article may have been the one he had encountered in Downtown Millbrae. Cafferata said that he called the Mercury News to tell them that he may have seen the person, but never heard back from the Mercury News. Cafferata said that he then left a message on the anonymous tip line at the San Mateo County Sheriff's Office, Redwood City Branch. Cafferata stated that he saw media coverage of the incident in Millbrae from October 3, 2018 and as soon as he saw photos of the decedent, he knew that was the same person he had encountered in Downtown Millbrae previously. Cafferata said that he contacted a Sergeant with the San Mateo County Sheriff's Office, Millbrae Division (Sergeant Dan Guiney) and provided him with that information and wanted to pass it along to investigators. Cafferata stated that he believed that the jewelry shop in downtown Millbrae may have cameras, but he wasn't sure if they retained footage from three weeks ago.

I asked some clarifying questions of Cafferata. Cafferata stated that he and his wife returned from Hawaii on "a Sunday", so the event he mentioned occurred on "Monday, Tuesday, Wednesday or Thursday." Cafferata estimated the date to be approximately the 20<sup>th</sup> or 21<sup>st</sup> of September. Cafferata estimated the time of the encounter to be in between 2:00 and 3:30 pm, stating that is the typical time that he and his wife normally walk.

I clarified the location with Cafferata as being in front of Numis International, Inc. which was located at 301 Broadway in Millbrae, at the intersection of La Cruz Avenue. Cafferata stated that he and his wife typically start a block south of that location and walk north from there. Cafferata said that they were on the west side of the street, walking north and the subject was walking south. Cafferata explained that as the subject crossed the street from the opposite side, he (the subject) was not holding the hand of the little boy that Cafferata believed was with him. Cafferata said, "The little boy could barely keep up with this guy." Cafferata stated, "I could tell he wasn't drunk, he was walking quickly in a straight line and in a strong fashion, not leisurely."

Cafferata stated that the little boy was trying to hold the subject's hand and he said that the little boy was

**CONTROLLED DOCUMENT**

Prepared By: 80202 MASSEY, BILL	Date: 10/20/2018	Approved By: 80240 WARREN, JOHN	Date: 12/18/2018
------------------------------------	---------------------	------------------------------------	---------------------



**CONTROLLED DOCUMENT**

approximately two feet away from the subject when he was yelling at the Cafferatas and then the little boy “followed him the whole rest of the way.”

Cafferata said that the subject came through parked cars and their paths intersected. Cafferata stated that the subject didn’t look at him, but he began yelling, “White folk, white people are calling the cops on the black folks.” Cafferata said, “That’s not right.” Cafferata stated that the subject walked approximately ten feet south of where they were and then he yelled the same thing again. Cafferata said that the subject walked another five or six feet south and there were other people around that were looking at what was happening. Cafferata stated that he responded to the individual, “Yeah, but I’ve never called the police on anybody.” Cafferata said that the subject stopped, turned around towards him and said, “But that don’t count.” Cafferata stated that even though the subject was looking in his direction, the subject wasn’t looking at him face to face, rather he was looking in his direction, but still off into space. Cafferata said that the subject turned back around again and walked off in the opposite direction, still south, but diagonally across the street to the side that he had started on.

Cafferata stated that he had seen media coverage of the event from the October 3<sup>rd</sup> incident and he and his wife were certain that the person they had seen on the news footage was the person he encountered on September 20<sup>th</sup> or 21<sup>st</sup>. I asked Cafferata to put aside the fact that he had seen media reports and had identified the subject as being the decedent from the October 3<sup>rd</sup> incident. I asked Cafferata to provide me with a description of the subject that he encountered.

Cafferata stated that he “had already heard” the subject’s physical description from the news, but he agreed that the subject was approximately 6’3” and he was heavy. Cafferata said that the news reports identified the subject as “3 and a quarter” (325 pounds) and he stated that he believed that by saying that the subject was twice his weight. Cafferata said that the subject wasn’t muscular, but he was “big” and he had “a little bit of a belly on him and he was round.” Cafferata stated that the subject was dressed casually, he had short hair and he was “medium colored black, he wasn’t real dark or real light.” Cafferata said that when the subject walked by him, he had to be at least three hundred pounds and he described him as “a big guy.”

Cafferata said, “When I walked away, I was thinking boy, something’s wrong with him, he wouldn’t even look, didn’t even look at me.” Cafferata stated, “This guy looked a little goofy, not normal at all.” Cafferata said that he felt the subject “just wanted to get something off of his chest” when he made the remarks to or near Emil Cafferata and his wife. Cafferata said, “Why me, I don’t know, but it was loud enough that people all, several stores up were turning and looking back at us” and Cafferata described the conversation as “loud.”

**Disposition:**  
Attach to Original Report

<b>Prepared By:</b> 80202 MASSEY, BILL	<b>Date:</b> 10/20/2018	<b>Approved By:</b> 80240 WARREN, JOHN	<b>Date:</b> 12/18/2018
---	----------------------------	---	----------------------------



**SAN MATEO COUNTY DISTRICT ATTORNEY'S OFFICE**

Page 4

400 COUNTY CENTER, 3RD FLOOR REDWOOD CITY, CA 94063 650-363-4636

**SUPPLEMENT 17 - Interview of Witness Emil Cafferata**

18-1003-02

**CONTROLLED DOCUMENT**

Prepared By:

80202 MASSEY, BILL

Date:

10/20/2018

Approved By:

80240 WARREN, JOHN

Date:

12/18/2018



**Supplemental Report to Case #18-1003-02:**

On October 17, 2018 at approximately 1330 hours, I met with San Mateo County Sheriff's Office Training Sergeant Bob Pronske at the San Mateo County Sheriff's Office/ Coyote Point Training Facility. Sergeant Pronske is the Lead Firearm and Taser Instructor for the San Mateo County Sheriff's Office. I personally transported the (5) tasers that had been issued to the Involved Sheriff's Deputies in the Millbrae incident from October 3, 2018 to the San Mateo County Sheriff's Office/ Coyote Point Training Facility. I was personally present the entire time while Sergeant Pronske conducted the taser downloads and Sergeant Pronske wore gloves the entire time, at my request. I retained custody of the tasers, following the downloads.

Sergeant Bob Pronske connected each of the following tasers and downloaded them utilizing Axon's software. Sergeant Pronske provided me with pdf copies of each taser download report.

(It should be noted that each taser download report will show a "Sync" event on October 17, 2018, which is when the individual taser was plugged in and downloaded by Sergeant Pronske).

The following are summaries of each download:

**Deputy Bryan Watt's assigned taser:**

Deputy Watt's X26 Taser (Serial #X00-380563)  
(SMCO DA's Office Bureau Case #18-1003-02, Evidence Item #23)

Deputy Watt's Taser X26 was last powered on October 1, 2018 at 05:24:51 hours for 5 seconds. That activation would be consistent with Deputy Watt conducting a 5 second "spark test" to ensure his assigned taser was functioning correctly.

Deputy Watt's Taser X26 did not appear to have been deployed in the October 3, 2018 incident in Millbrae.

(Please refer to the attached 37 page pdf entitled Deputy Watt's Taser Download for specific details).

**Deputy John Demartini's assigned taser:**

Deputy Demartini's X26 Taser (Serial #X00-564295)  
(SMCO DA's Office Bureau Case #18-1003-02, Evidence Item #24)

Deputy Demartini's Taser X26 was last powered on September 27, 2018 at 05:56:20 hours for 5 seconds. That activation would be consistent with Deputy Demartini conducting a 5 second "spark test" to ensure his assigned taser was functioning correctly.

Deputy Demartini's Taser X26 did not appear to have been deployed in the October 3, 2018 incident in Millbrae.

(Please refer to the attached 4 page pdf entitled Deputy Demartini's Taser Download for specific details).

**Sergeant David Weidner's assigned taser:**

Sergeant Weidner's X26P Taser (Serial #X13001W86)

**CONTROLLED DOCUMENT**

Prepared By: 80202 MASSEY, BILL	Date: 10/22/2018	Approved By: 80240 WARREN, JOHN	Date: 12/18/2018
------------------------------------	---------------------	------------------------------------	---------------------





(SMCO DA's Office Bureau Case #18-1003-02, Evidence Item #7)

Sergeant Weidner's Taser X26P was "Armed" on October 3, 2018 at 13:17:17 hours and then placed back on "Safe" on October 3, 2017 at 13:17:30. Sergeant Weidner's Taser X26P did not appear to have been deployed in the October 3, 2018 incident in Millbrae, other than being taken out of the holster, taken off of "Safe" or "Armed" and then placed back on "Safe" approximately 13 seconds later. That information is corroborated by video at the scene showing Sergeant Weidner with his Taser X26P in his hand and then re-holstering it.

(Please refer to the attached 41 page pdf entitled Sergeant Weidner's Taser Download for specific details).

**Deputy Alyssa Lorenzatti's assigned taser:**

Deputy Lorenzatti's X26P Taser (Serial #X13004AD5)

(SMCO DA's Office Bureau Case #18-1003-02, Evidence Item #6)

Deputy Lorenzatti's Taser X26P had the following activity on October 3, 2018:

- 13:32:00 Armed
- 13:32:05 Safe
- 13:32:07 Armed
- 13:32:07 Safe
- 13:33:15 Armed
- 13:33:17 Safe
- 13:33:30 Armed
- 13:33:46 Safe
- 13:33:48 Armed
- 13:33:48 Safe
- 13:33:51 Armed
- 13:33:51 Safe

Deputy Lorenzatti's Taser X26P did not appear to have been deployed in the October 3, 2018 incident in Millbrae, other than being taken out of the holster, taken off of "Safe" or "Armed" and then placed back on "Safe", armed and then placed back on safe a total of six separate times in between 13:32:00 and 13:33:51 (1 minute and 51 seconds). That information is corroborated by video at the scene showing Deputy Lorenzatti with her Taser X26P in her hand, but not deploying it.

(Please refer to the attached 18 page pdf entitled Deputy Lorenzatti's Taser Download for specific details).

**CONTROLLED DOCUMENT**

Prepared By: 80202 MASSEY, BILL	Date: 10/22/2018	Approved By: 80240 WARREN, JOHN	Date: 12/18/2018
------------------------------------	---------------------	------------------------------------	---------------------



**Deputy Joshua Wang:**

Deputy Wang's X26P Taser (Serial #X13004A6P)  
(SMCO DA's Office Bureau Case #18-1003-02, Evidence Item #5)

Deputy Wang's Taser X26P had the following activity on October 3, 2018:

- 05:38:25 Armed
- 05:38:27 Trigger Duration of 5 seconds
- 05:38:33 Safe

The above actions are consistent with Deputy Wang conducting a 5 second "spark test" to ensure his assigned taser was functioning correctly on the morning of October 3, 2018.

- 13:08:17 Armed
- 13:08:18 Trigger Duration of 5 seconds
- 13:08:32 Trigger Duration of 5 seconds
- 13:08:46 Trigger Duration of 5 seconds
- 13:09:19 Trigger Duration of 5 seconds
- 13:09:31 Trigger Duration of 5 seconds
- 13:09:41 Trigger Duration of 5 seconds
- 13:09:52 Trigger Duration of 4 seconds
- 13:09:56 Safe
- 13:10:00 Armed
- 13:30:09 Powersave (20 minute weapon timer)

Using the times listed in Deputy Wang's Taser X26P event log, the listed taser deployments occurred in the following fashion:

- 13:08:18 Deployed for 5 seconds, ending at 13:08:23  
*Pause in activity for 9 seconds*
- 13:08:32 Deployed for 5 seconds, ending at 13:08:37  
*Pause in activity for 9 seconds*
- 13:08:46 Deployed for 5 seconds, ending at 13:08:51  
*Pause in activity for 28 seconds*
- 13:09:19 Deployed for 5 seconds, ending at 13:09:24  
*Pause in activity for 7 seconds*
- 13:09:31 Deployed for 5 seconds, ending at 13:09:36  
*Pause in activity for 5 seconds*
- 13:09:41 Deployed for 5 seconds, ending at 13:09:46  
*Pause in activity for 6 seconds*
- 13:09:52 Deployed for 4 seconds, ending at 13:09:56

**CONTROLLED DOCUMENT**

Prepared By:  
80202 MASSEY, BILL

Date:  
10/22/2018

Approved By:  
80240 WARREN, JOHN

Date:  
12/18/2018



(Please refer to the attached 17 page pdf entitled Deputy Wang's Taser Download for specific details).

In my discussions with Sergeant Pronske, he stated that the 13:08:17 "Armed" activation indicated that Deputy Wang un-holstered his taser and took the safety off, effectively arming it for deployment. The subsequent "Trigger" 4 and 5 second log entries indicated that Deputy Wang pulled the trigger and deployed his Taser X26P. Sergeant Pronske stated that the San Mateo County Sheriff's Office trains their staff members to pull the trigger on their assigned taser and then release the trigger. That pull and release action to the trigger places the taser in a mode where it automatically delivers a maximum 5 second shock cycle, unless manually shut down, prior to the elapsed 5 seconds. A user could place the taser in "Safe" mode, which will automatically stop delivering any type of shock. Sergeant Pronske stated that the last "Trigger" cycle logged on Deputy Wang's taser (13:09:52) only had a duration of 4 seconds and the entry at 13:09:56 showed "Safe", which indicated that Deputy Wang manually stopped the automatic 5 second cycle after 4 seconds by placing the safety mechanism on.

Sergeant Pronske informed me that Taser X26 and X26P's could be deployed and activated for longer than 5 seconds by pulling and holding the trigger. Sergeant Pronske stated that holding the trigger down would signal the taser to continue a shock cycle longer than 5 seconds and that cycle could last until the battery in the taser ran out. Sergeant Pronske believed that when a trigger is pressed and held on the tasers, a deployment over 5 seconds would continue a shock cycle, but would decrease the power of the shock.

Sergeant Pronske stated that the San Mateo County Sheriff's Office trains staff members to pull and release the triggers on the taser, deploying a maximum 5 second cycle. Once a 5 second cycle has concluded, Sergeant Pronske stated that San Mateo County Sheriff's Office members are trained to re-assess the situation and only deploy another 5 second cycle (trigger pull and release), if necessary. Sergeant Pronske stated that was what he saw when reviewing the event log for Deputy Wang's Taser X26P. Deputy Wang appears to have deployed his Taser X26P for a total of (6) 5 second cycles and (1) 4 second cycle, indicating that Deputy Wang pulled the trigger and released and then manually placed the taser into safe mode on the last deployment cycle at the 4 second mark. Nothing in the event log indicted to Sergeant Pronske that Deputy Wang pulled and held the trigger, which would have deployed a shock cycle longer than 5 seconds.

I was familiar with discrepancies in times on taser event logs from previous investigations, but I asked Sergeant Pronske about the differences in "Armed, Safe and Trigger" event times for Deputy Wang's, Deputy Lorenzatti's and Sergeant's Weidner's tasers. Specifically, Deputy Wang's Taser X26P showed an initial "Armed" time stamp of 13:08:17, Deputy Lorenzatti's Taser X26P showed an initial "Armed" time stamp of 13:32:00, and Sergeant Weidner's Taser X26P showed an initial "Armed" time stamp of 13:17:17. Sergeant Pronske stated that the duration times should all be accurate, but the actual event times (hours, minutes and seconds) on the tasers can deviate and are only completely accurate when

**CONTROLLED DOCUMENT**

Prepared By: 80202 MASSEY, BILL	Date: 10/22/2018	Approved By: 80240 WARREN, JOHN	Date: 12/18/2018
------------------------------------	---------------------	------------------------------------	---------------------



“Synched” with the Axon/ Taser software.

That information was consistent with what Inspector Kevin Raffaelli was told by Axon Corporation Technical Services Division on January 25, 2018, when he contacted them for San Mateo County District Attorney’s Office Bureau of Investigations Case #18-0117-02. Inspector Raffaelli was told by Axon (the manufacturer of Taser X26 and Taser X26P’s) the following:

*The ‘Time Sync’ occurs after the download takes place, so the data (time) which is listed for the Taser activation is based on the time of the internal clock on the Taser. Once the download is complete, the ‘Time sync’ (adjusted time) would be updated in the Taser clock.*

The last time Deputy Wang’s Taser X26P was plugged in for a “Time Sync” was on October 2, 2017 at 19:04:47 hours.

The last time Deputy Lorenzatti’s Taser X26P was plugged in for a “Time Sync” was on July 18, 2016 at 13:20:10 hours. There were two other “Configuration” events in Deputy Lorenzatti’s Taser X26P event log that may have updated the internal clock in between July 18, 2016 and October 3, 2018, but even the most recent one was October 27, 2017 at 17:07:31 hours.

The last time Sergeant Weidner’s Taser X26P was plugged in for a “Time Sync” was May 9, 2016 at 14:54:40 hours. Like Deputy Lorenzatti’s Taser X26P, there were other “Configuration” events in Sergeant Weidner’s Taser X26P event log that may have updated the internal clock in between May 9, 2016 and October 3, 2018, but even the most recent one was March 6, 2017 at 09:46:18.

Sergeant Pronske identified the two types of tasers carried by the San Mateo County Sheriff’s Office personnel as the Axon Taser X26 and Axon Taser X26P. Sergeant Pronske stated that the X26P was a newer version of the X26. Sergeant Pronske stated that Axon has introduced a newer version of the taser, the Taser 7, but that product is very new to the market and the San Mateo County Sheriff’s Office has not purchased any Taser 7’s at this time. Sergeant Pronske confirmed that Deputies Watt and Demartini were issued and were carrying the Taser X26 and Deputies Wang, Lorenzatti and Sergeant Weidner had been issued and were carrying the newer X26P versions. Sergeant Pronske also stated that Sergeant David Weidner is a taser instructor for the San Mateo County Sheriff’s Office.

**San Mateo County Sheriff’s Office Conducted Energy Device (Taser) Policy:**

Sergeant Pronske provided me with San Mateo County Sheriff’s Office Policy #304, entitled Conducted Energy Device (Taser). Sergeant Pronske stated that Policy #304 is the most current taser policy that was in effect on October 3, 2108.

Section 7 on page 2 of the policy specifically states:

*The TASER shall be activated against a suspect for no more than five seconds whereupon an evaluation will be made to determine if further use is required. Deputy / Sergeants should consider whether a full*

**CONTROLLED DOCUMENT**

Prepared By: 80202 MASSEY, BILL	Date: 10/22/2018	Approved By: 80240 WARREN, JOHN	Date: 12/18/2018
------------------------------------	---------------------	------------------------------------	---------------------





*five second cycle is necessary to gain compliance. During this evaluation clear orders should be given to the subject. If additional cycles are required, the number and duration of those cycles shall be the minimum number of activations necessary to take the person into custody.*

The listed policy was consistent with the training that Sergeant Pronske referred to, specifically deploying the taser for a maximum of 5 seconds (trigger pull and release) and then re-assessing after the completion of a 5 second cycle.

(Please refer to attached San Mateo County Sheriff's Office Policy #304, entitled Conducted Energy Device (Taser).

**San Mateo County Sheriff's Office Conducted Energy Device (Taser) Training:**

Sergeant Pronske stated that all San Mateo County Sheriff's Office employees who are eligible to carry tasers (Deputies, Sergeants, Lieutenants, Captains and other Command Staff Members) are required to attend a 6 hour minimum training course initially, prior to being issued a taser. Sergeant Pronske said that the San Mateo County Sheriff's Office also offers a 4 hour training refresher course on the taser that is offered as needed. Sergeant Pronske provided me with a 207 slide Powerpoint presentation which was marked as Version 20- Effective January 1, 2016. Sergeant Pronske stated that the 207 slide Powerpoint presentation was the most current training presentation that was being utilized in all San Mateo County Sheriff's Office training sessions.

(Please refer to attached training Powerpoint presentation, entitled X26P User Course V20).

On October 19, 2018 at approximately 1330 hours, I personally booked Deputy Joshua Wang's assigned Taser X26P (Serial #X13004A6P and SMC0 DA's Office Bureau Case #18-1003-02, Evidence Item # 5) into the Property and Evidence area of the San Mateo County Sheriff's Office.

On October 22, 2018 at approximately 1400 hours, I turned over the other four tasers to San Mateo County Sheriff's Office Professional Standards Sergeant, Jon Sebring. The four tasers released were:  
Deputy Watt's X26 Taser (Serial #X00-380563)  
(SMCO DA's Office Bureau Case #18-1003-02, Evidence Item #23)

Deputy Demartini's X26 Taser (Serial #X00-564295)  
(SMCO DA's Office Bureau Case #18-1003-02, Evidence Item #24)

Sergeant Weidner's X26P Taser (Serial #X13001W86)  
(SMCO DA's Office Bureau Case #18-1003-02, Evidence Item #7)

**CONTROLLED DOCUMENT**

<b>Prepared By:</b> 80202 MASSEY, BILL	<b>Date:</b> 10/22/2018	<b>Approved By:</b> 80240 WARREN, JOHN	<b>Date:</b> 12/18/2018
---	----------------------------	---	----------------------------



Deputy Lorenzatti's X26P Taser (Serial #X13004AD5)  
(SMCO DA's Office Bureau Case #18-1003-02, Evidence Item #6)

**End of supplemental report.**

**CONTROLLED DOCUMENT**

Prepared By:  
80202 MASSEY, BILL

Date:  
10/22/2018

Approved By:  
80240 WARREN, JOHN

Date:  
12/18/2018



**SAN MATEO COUNTY DISTRICT ATTORNEY'S OFFICE**

400 COUNTY CENTER, 3RD FLOOR REDWOOD CITY, CA 94063 650-363-4636

SUPPLEMENT 19 - Dispatch Transcript

18-1003-02

**CONTROLLED DOCUMENT**

October 3, 2018 13:01:02

B62: County, Boy-62

D: 2-Boy-62

B62: Can you put me on a ped-stop at ECR and Capuchino and can you roll me one more unit please?

D: Affirm, unit to cover 62 at ECR and Cap?

Unit: 2 Enroute

D: 10-4

B62: And if you can send them code-3, he's running on ECR into traffic

D: Copy, code-3 to Capuchino and ECR

Unit: Garbled

D: 10-4; 61 are you in pursuit?

B60: Boy-60 en route

D: Boy-60, 10-4

D: Correction, Boy-62 are you in pursuit?

B62: He's on foot. I'm paralleling him on ECR, he's BMA about 6 feet tall about 220 pounds wearing blue and black striped shirt. Still walking in traffic

D: BMA, 6 foot, 220, blue and black striped shirt, not in pursuit

B62: Still northbound ECR, we're at Santa Helena, still running in traffic

D: Northbound ECR at Santa Helena running in traffic

S60: 62, Sam-60, update?

B62: Still walking northbound ECR

D: Walking northbound ECR

B62: To the unit coming northbound on ECR, he's on the median of ECR

Prepared By:  
80203 BOYD, JORDAN

Date:  
10/26/2018

Approved By:  
80240 WARREN, JOHN

Date:  
12/17/2018





CONTROLLED DOCUMENT

S60: Sam-60, all units 97 [on-scene]

D: 2-Sam-60, 10-4

T207: County, Transit-207, good morning, 10-8

D: 10-4

S60: Code 33 [restrict radio traffic], Taser deployment (3 min; 25 sec)

D: Copy, Taser deployment, code-33 this channel 13:04

Unit: Garbled

B62: Still resisting, second Taser deployment

D: Copy no resistance, sending fire and medics code 3

B62: Boy-62, he's still resisting

D: Copy, still resisting

B62: Boy-62, can you roll medics?

D: Affirm, they're en route code-3

D: Boy-62, what's our best location for fire and medics?

S60: Sam-60, code-3 cover (unintelligible)

D: Copy, code-3 cover, ECR and Santa Helena

T908: Transit-908, responding, code-3

D: 908 en route

S25: Sam-25, I'm right behind him

D: 10-4

S60: Sam-60

D: 2-Sam-60, go ahead

Prepared By: 80203 BOYD, JORDAN

Date: 10/26/2018

Approved By: 80240 WARREN, JOHN

Date: 12/17/2018



**CONTROLLED DOCUMENT**

S60: We need medics, code-3,

D: Affirm, they're en route, just confirm ECR and Santa Helena is best place for their response?

S60: ECR, just north of Millwood Drive

D: Copy, ECR just north of Millwood, they're en route code-3

S60: Sam-60

D: 2-Sam-60, go ahead

S60: Subject is 11-5, several Taser deployments, pepper spray deployment... I think I have a few deputies hurt.

D: 10-4, do we need a second ambulance?

S60: Can you get Alpha-7 out here?

D: Affirm.

T908: 908, I'm here

D: 10-4

S10: Sam-50 from 10, you want additional units from us?

B71: Sam-10, Boy-71, want me to head up?

S10: Affirm, till code-4.

B62: Boy-62, confirm you have medics coming code-3?

D: Affirm, en route code-3 to ECR at Millwood to stage

D: 62, can I get a scene secure for them?

B62: Yes, scene is secure. Please send them in code-3

D: Copy, scene secure

B10: Boy-10, show me en route till code-4

D: 10-4

Prepared By:  
80203 BOYD, JORDAN

Date:  
10/26/2018

Approved By:  
80240 WARREN, JOHN

Date:  
12/17/2018



CONTROLLED DOCUMENT

S60: Sam-60

D: 2-Sam-60

S60: I need units to start shutting down the intersection of Santa Helena and ECR, by Zorba's pizza. We have a crime scene

D: Copy. Need additional units to Santa Helena and ECR

S60: If San Bruno can help us out, that'd be great. We have several deputies that have been pepper strayed as well.

D: Affirm. They are en route

Unit: Capuchino and ECR (unintelligible)

S25: Sam-25

S25: Need you to shut down Millwood and ECR, right there, so we can photo the scene and all that

S60: Sam-60, confirm Alpha-7 was advised?

D: We're working on that notification

T908: 908, we need medics, code-4. Code-4 for medics

D: Affirm, I'll advise them scene is secure (12 min 12 sec)

Prepared By: 80203 BOYD, JORDAN

Date: 10/26/2018

Approved By: 80240 WARREN, JOHN

Date: 12/17/2018



**SAN MATEO COUNTY DISTRICT ATTORNEY'S OFFICE**

400 COUNTY CENTER, 3RD FLOOR REDWOOD CITY, CA 94063 650-363-4636

SUPPLEMENT 20 - Civilian Video - Dennis Barboza

18-1003-02

On 10-26-18, I spoke to Dennis Barboza regarding the interior video for his store located at 1486 El Camino Real in Millbrae to determine if the camera had captured anything relevant to this investigation. He in turn emailed me a link to the video captured at the time of the incident. I then used that link to download and retain it as evidence in this case.

<https://video.nest.com/clip/7c0a6fb4e75e4a9f8e8e5f8460872639.mp4> <<https://protect-us.mimecast.com/s/vumuCVO27pfPB4mrTGdNrV>>

The video itself does not seem to capture relevant details of the event, neither visually nor audibly. The exterior view is distorted by sunlight and related glare from the windows.

The video will still be retained as evidence.

**END OF REPORT**

**CONTROLLED DOCUMENT**

Prepared By:  
80251 DECKER, RICK

Date:  
10/26/2018

Approved By:  
80240 WARREN, JOHN

Date:  
12/18/2018



**Investigation:**

On October 17, 2018, I contacted San Mateo County Sheriff's Office Technology Unit Supervisor, Steven Yu. Steven Yu identified the Mobile Audio Video (MAV) system that the San Mateo County Sheriff's Office utilizes in the Millbrae patrol vehicles as WatchGuard MAV. Steven Yu provided a list of "triggers" that start or flag a recording for upload to the Digital Video Recorder (DVR). The list of triggers Steven Yu provided are listed below:

1. The activation of the patrol vehicle light bar.
2. The activation of the WatchGuard Video system's wireless microphone.
3. A sudden crash of the patrol vehicle.
4. The patrol vehicle's speed over 83 mph.
5. The manual activation by the officer or deputy.

Steven Yu told me that the WatchGuard MAV system is constantly recording and when one of the above "triggers" occur, the WatchGuard MAV system is configured to mark the recording 30 seconds prior to the trigger. The 30 seconds that is marked (pre-trigger) is then recorded onto the DVR, along with the event itself. Steven Yu stated that the pre-trigger time (30 seconds) does not include audio.

Steve Yu confirmed that all of the San Mateo County Sheriff's Office (Millbrae) patrol vehicles had the flagged event, along with the 30 second pre-incident segment (when applicable) downloaded as part of the on-going investigation. I confirmed with Steve Yu that the WatchGuard MAV systems are "always" recording and Steven Yu confirmed that was correct. With that information, I asked Steven Yu if it would be possible to obtain recorded footage from Vehicle MB10 (Deputy Joshua Wang's assigned vehicle) on October 3, 2018 that occurred prior to the actual trigger and 30 second pre-trigger segment. Steven Yu personally responded to the San Mateo County Sheriff's Office Millbrae Substation on October 17, 2018. Steven Yu removed the DVR from Vehicle MB10 to see if he could recover any additional events or recordings from the October 3, 2018 incident. Steven Yu re-contacted me later on October 17<sup>th</sup> to inform me that events prior to October 13, 2108 on the DVR inside MB10 had been recorded or written over.

**Disposition:**

Attach to Original Report

**CONTROLLED DOCUMENT**



**Investigation:**

On October 4, 2018, DA Inspector Greg Giguere received a total of 11 digital video files from Tri Counties Bank Business Continuity and Security Officer, Richard Ellena. The 11 digital video files contained footage from the ATM machine in front of the Tri Counties Bank located at 1551 El Camino Real in Millbrae, CA from October 3, 2018. The ATM camera was pointed directly in front of the bank and should have been in position to capture footage from the event on October 3, 2018 that our office is investigating.

I have provided a summary of the digital video files below. It should be noted that the quality and clarity of the videos are poor.

Video #1 labeled:

Embedded Net DVR\_10.3.43.20\_11\_20181003130037\_20181003130048\_15386713010...

The date and time shown at the beginning of the video was:

10-03-2018 at 13:00:32

The video was approximately 9 seconds in length total

Due to the poor quality of the video, I did not observe anything of evidentiary value on the 9 second video.

Video #2 labeled:

Embedded Net DVR\_10.3.43.20\_11\_20181003130124\_20181003130135\_15386713227...

The date and time shown at the beginning of the video was:

10-03-2018 at 13:01:20

The video was approximately 6 seconds in length total

A San Mateo County Sheriff's Office vehicle with overhead lights on can be seen in the middle of the intersection. The vehicle is believed to be MB #10, Deputy Joshua Wang's patrol vehicle. A person, believed to be Decedent Chinedu Okobi can be seen moving quickly northbound across the street from the ATM camera, while the SMCO SO patrol vehicle moves slowly behind the person.

Video #3 labeled:

Embedded Net DVR\_10.3.43.20\_11\_20181003130220\_20181003130412\_15386713242...

The date and time shown at the beginning of the video was:

10-03-2018 at 13:02:16

The video was approximately 1 minute, 50 seconds in length total

At approximately 13:02:23, a white male adult walks up to the ATM and begins using the ATM machine. In addition to the overall poor quality of the video, the male's body covers a good portion of the screen.

At 13:02:34, a San Mateo County Sheriff's Office vehicle with overhead lights on arrives and pulls up in front of the bank on the wrong side of the street. That vehicle was identified as Deputy Lorenzatti's patrol vehicle.

**CONTROLLED DOCUMENT**

Prepared By:  
80202 MASSEY, BILL

Date:  
11/03/2018

Approved By:  
80240 WARREN, JOHN

Date:  
12/18/2018





At 13:02:43, Deputy Lorenzatti can be seen moving into view of the camera northbound on the sidewalk area, in front of the bank.

At 13:02:45, a second San Mateo County Sheriff's Office vehicle with overhead lights on arrives and pulls up in front of the bank, further north on the wrong side of the street. That vehicle was identified as Deputy Demartini's patrol vehicle.

At 13:02:47, Deputy Lorenzatti can be seen pointing in the direction of where Decedent Chinedu Okobi was walking (based upon my review of other available videos).

At 13:02:54, Deputy Demartini can be seen running towards Decedent Chinedu Okobi, who has just entered into the far left side view of the ATM camera.

At 13:02:54, Deputy Demartini can be seen attempting to grab Decedent Chinedu Okobi as Okobi raises his hands. Deputy Lorenzatti appears to be attempting to also grab Okobi.

At 13:02:57, the customer at the ATM machine looks at what is occurring behind him and at the same time, he blocks a large portion of what would have been caught on the camera.

At 13:02:57, Deputy Demartini appears to be trying to hold onto Decedent Chinedu Okobi's sweater, while Deputy Lorenzatti is behind Okobi, Deputy Wang is running towards Okobi and the other two deputies from the left side of the camera angle.

At 13:03:01, the three deputies and Decedent Chinedu Okobi are to the far right of the screen and barely visible to the ATM camera.

At 13:03:07, Decedent Chinedu Okobi has pulled away from the deputies and the customer at the ATM machine has backed up against the ATM machine, blocking almost the entire screen.

Most of what occurs in between 13:03:07 and 13:03:31 can hardly be seen due to the customer at the ATM machine blocking the camera view (as he continues his ATM transaction, despite the struggle that is going on behind him).

At 13:04:01, the customer at the ATM machine finishes his transaction and leaves the ATM machine. At that time, the San Mateo County Sheriff's Deputies and Decedent Chinedu Okobi are to the far right of the screen. Due to the poor video quality, it is extremely difficult to see much of what is occurring. Due to the existence of better quality videos, I have not documented any of the actions that cannot be seen clearly in the ATM videos.

**CONTROLLED DOCUMENT**

Prepared By:  
80202 MASSEY, BILL

Date:  
11/03/2018

Approved By:  
80240 WARREN, JOHN

Date:  
12/18/2018





**CONTROLLED DOCUMENT**

Video #4 labeled:

Embedded Net DVR\_10.3.43.20\_11\_20181003130510\_20181003130529\_15386713287...

The date and time shown at the beginning of the video was:

10-03-2018 at 13:05:05

The video was approximately 15 seconds in length total

Nothing of significant evidentiary value occurs in this video.

Video #5 labeled:

Embedded Net DVR\_10.3.43.20\_11\_20181003130532\_20181003130545\_15386713302...

The date and time shown at the beginning of the video was:

10-03-2018 at 13:05:30

The video was approximately 6 seconds in length total

Nothing of significant evidentiary value occurs in this video.

Video #6 labeled:

Embedded Net DVR\_10.3.43.20\_11\_20181003130607\_20181003130619\_15386713317...

The date and time shown at the beginning of the video was:

10-03-2018 at 13:06:02

The video was approximately 9 seconds in length total

Nothing of significant evidentiary value occurs in this video.

Video #7 labeled:

Embedded Net DVR\_10.3.43.20\_11\_20181003130711\_20181003130723\_15386713331...

The date and time shown at the beginning of the video was:

10-03-2018 at 13:07:06

The video was approximately 8 seconds in length total

Nothing of significant evidentiary value occurs in this video.

Video #8 labeled:

Embedded Net DVR\_10.3.43.20\_11\_20181003130741\_20181003130753\_15386713347...

The date and time shown at the beginning of the video was:

10-03-2018 at 13:07:36

The video was approximately 7 seconds in length total

Nothing of significant evidentiary value occurs in this video.

Video #9 labeled:

Embedded Net DVR\_10.3.43.20\_11\_20181003130805\_20181003130818\_15386713361...

The date and time shown at the beginning of the video was:

10-03-2018 at 13:08:00

The video was approximately 8 seconds in length total

<b>Prepared By:</b> 80202 MASSEY, BILL	<b>Date:</b> 11/03/2018	<b>Approved By:</b> 80240 WARREN, JOHN	<b>Date:</b> 12/18/2018
---	----------------------------	---	----------------------------



Nothing of significant evidentiary value occurs in this video.

Video #10 labeled:

Embedded Net DVR\_10.3.43.20\_11\_20181003131518\_20181003131536\_15386713377...

The date and time shown at the beginning of the video was:

10-03-2018 at 13:15:13

The video was approximately 14 seconds in length total

Nothing of significant evidentiary value occurs in this video.

Video #11 labeled:

Embedded Net DVR\_10.3.43.20\_11\_20181003131553\_20181003131607\_15386713392...

The date and time shown at the beginning of the video was:

10-03-2018 at 13:15:49

The video was approximately 9 seconds in length total

Nothing of significant evidentiary value occurs in this video.

**Disposition:**

Attach to Original Report

**CONTROLLED DOCUMENT**

Prepared By:  
80202 MASSEY, BILL

Date:  
11/03/2018

Approved By:  
80240 WARREN, JOHN

Date:  
12/18/2018



**Investigation:**

Menlo Park Police Detectives Jeremy Ordone and Josh Russell responded to the scene of the Millbrae Officer Involved Critical Incident on October 3, 2018 as part of the San Mateo County Officer Involved Critical Incident Team. Detectives Ordone and Russell documented the interviews they conducted in Menlo Park Police Department Report #18-2659 (attached to the main investigative report). Detectives Ordone and Russell had the following surveillance and/or cell phone videos turned over to them as part of their witness interviews:

- Witness Brenda Landeros: Cell phone video (1 video file entitled video 000000)
- Days Inn: Garage surveillance video entitled 20181003125953\_20181003130241\_2\_20181011140707
- Witness Mayra Martinez: Cell phone video (3 video files entitled IMG\_2089, IMG\_2090 and IMG\_2091)

I have summarized the content of the above listed video files below:

**Brenda Landeros' Video 000000**

According to Detective Russell's report, Brenda Landeros is an employee of the Days Inn and she recorded a portion of the event on her cell phone from the front (or near the front) of the Days Inn Hotel.

The video clip is approximately 19 seconds in length and playback works best using QuickTime Player. The video is poor quality and pixelated due to the distance Brenda Landeros was attempting to film from.

At approximately the 00:006 mark: Decedent Chinedu Okobi can be seen standing up and running backwards from the San Mateo County Sheriff's Deputies. Landeros then moves the cell phone significantly, focusing on a pole momentarily and then shaking the phone while moving it. Another person (a male subject) then steps in front of the cell phone and the video recording ends at the approximate 19 second mark.

**Days Inn Surveillance Video 20181003125953\_20181003130241\_2\_20181011140707**

The video clip is approximately 2 minutes and 49 seconds in length total. The camera is labeled "Outside Garage" and the vantage point shows empty parking spaces in the underground parking garage for the Days Inn along with a portion of El Camino Real in front of the Days Inn. The video featured the date of 10-03-2018 and the video began at 12:59:53 pm.

At approximately the 00:001 mark: Decedent Chinedu Okobi can be seen standing in the center median of El Camino Real, appearing to walk across El Camino Real to the east side of the street.

At approximately the 00:004 mark: Decedent Okobi quickly changes directions, turns around and crosses El Camino Real through medium southbound traffic in a northwest direction.

**CONTROLLED DOCUMENT**

Prepared By: 80202 MASSEY, BILL	Date: 11/06/2018	Approved By: 80240 WARREN, JOHN	Date: 12/18/2018
------------------------------------	---------------------	------------------------------------	---------------------



**CONTROLLED DOCUMENT**

At approximately the 00:16 mark: A San Mateo County Sheriff's Office SUV drives northbound on El Camino Real. (I believe this is SMCO SO patrol vehicle MB #10, driven by Deputy Joshua Wang). It should be noted that a large wall blocks the camera from being able to see Decedent Okobi's location as the SMCO SO patrol vehicle passes northbound on El Camino Real.

At approximately the 00:23 mark: Decedent Okobi can be seen in on the west sidewalk area in front of Zorbas Pizza, located at 1567 El Camino Real.

At approximately the 00:25 mark: Decedent Okobi can be seen starting to cross El Camino Real in medium traffic in a northeast direction.

At approximately the 00:31 mark: Decedent Okobi disappears from camera view as he makes his way to the center median area of El Camino Real, still walking in a northeast direction.

At approximately the 00:41 mark: Decedent Okobi can be seen running back across El Camino Real in medium traffic, in a southwest direction, back towards Zorbas Pizza. Decedent Okobi disappears behind a large wall that blocks the camera view.

At approximately the 00:57 mark: Decedent Okobi can be seen walking southbound on the sidewalk on the west side of the street, close to Tri Counties Bank, located at 1551 El Camino Real.

At approximately the 00:59 mark: Deputy Wang's patrol SUV can be seen traveling slowly southbound on El Camino Real with the overhead rotating lights activated, directly behind Decedent Okobi who continues to walk southbound on the sidewalk.

At approximately the 01:03 mark: Deputy Demartini's patrol SUV can be seen pulling up in front of Tri Counties Bank, northbound in the southbound lanes. At the same time, Deputy Wang's patrol SUV can be seen pulling slowly to the right side of El Camino Real (southbound).

At approximately the 01:07 mark: Deputy Wang can be seen stopping his vehicle and exiting his patrol SUV.

At approximately the 01:10 mark: Deputy Wang can be seen running southbound towards the west sidewalk area, in front of Tri Counties Bank.

Due to the distance from the Days Inn "Outside Garage" camera, very little of the remaining footage is of much evidentiary value. In addition to the distance, Deputy Demartini's patrol vehicle blocks the view of the sidewalk area on the west side of the street and there is a significant glare from the outside vantage point and large walls that obstruct the view.

Prepared By:  
80202 MASSEY, BILL

Date:  
11/06/2018

Approved By:  
80240 WARREN, JOHN

Date:  
12/18/2018



**Mayra Martinez's Videos IMG\_2089, IMG\_2090 and IMG\_2091**

According to Detective Ordone's report, Mayra Martinez recorded a portion of the event on her cell phone from near the front of Tri Counties Bank (also known as First American Bank) located at 1551 El Camino Real.

IMG\_2089 is approximately 41 seconds in length and playback works best in QuickTime Player. The 41 second video begins after Decedent Okobi has been handcuffed and Okobi is propped up in a sitting position against the knees of one of the San Mateo County Sheriff's Office Deputies standing behind him. A motor officer arrives on scene and is being directed by Sergeant Weidner to block off traffic in the area.

IMG\_2090 is approximately 23 seconds in length and playback works best in QuickTime Player. The 23 second video begins with Decedent Okobi still handcuffed and propped up in the same sitting position against the knees of one of the San Mateo County Sheriff's Office Deputies.

IMG\_2091 is approximately 12 seconds in length and playback works best in QuickTime Player. The 12 second video begins with two ambulances stopped behind the San Mateo County Sheriff's Office CSO pickup truck and the location where Decedent Okobi was handcuffed. The video simply shows law enforcement officers, fire department and emergency medical (ambulance) personnel moving around and getting a transport gurney from the rear of one of the ambulances.

**Disposition:**

Attach to Original Report

**CONTROLLED DOCUMENT**





**Investigation:**

On October 5, 2018, I drafted a letter to San Mateo County Sheriff Carlos Bolanos requesting to review the personnel files of the following listed Sheriff's Office Deputies and Sergeant, pursuant to California Penal Code Section 832.7(a):

- Sergeant David Weidner
- Deputy Joshua Wang
- Deputy Bryan Watt
- Deputy Alyssa Lorenzatti
- Deputy John Demartini

On November 2, 2018, I personally met with San Mateo County Sheriff's Office Professional Standards Bureau Sergeant Jon Sebring to begin the process of reviewing the listed personnel files. On November 2, 2018, I reviewed the first two personnel files belonging to Deputy Joshua Wang and Sergeant David Weidner.

I have summarized my review of each Deputy/Sergeant's personnel file below:

**Deputy Joshua Wang**

Deputy Wang was hired by the San Mateo County Sheriff's Office on February 26, 2018 as a Deputy Sheriff Lateral hire. Wang graduated from the (1184 hour) Basic Police Academy on May 3, 2013, while employed by the San Francisco Police Department. Joshua Wang was previously employed by the San Francisco Police Department from May 3, 2013 through February 25, 2018.

Deputy Wang possesses a Bachelor's Degree in Political Science/ English.

Deputy Wang possesses an Intermediate Certificate through POST/ Peace Officer Standards and Training.

Deputy Wang did not have any performance evaluations in his personnel file to date.

Deputy Wang did not have any written commendations, complaints or internal affair investigations in his personnel file.

**Sergeant David Weidner:**

Sergeant Weidner was hired by the San Mateo County Sheriff's Office on July 10, 2000 as a Correctional Officer. Weidner graduated from the (880 hour) Basic Police Academy on August 16, 2002. Once David Weidner graduated from the police academy, he was promoted from Correctional Officer to Deputy Sheriff on August 16, 2002. David Weidner was promoted to the rank of Sheriff's Sergeant on October 23, 2016.

Sergeant Weidner possesses a Bachelor's Degree in Organizational Security and Management.

Sergeant Weidner possesses an Advanced Certificate through POST/ Peace Officer Standards and Training.

**CONTROLLED DOCUMENT**

<b>Prepared By:</b> 80202 MASSEY, BILL	<b>Date:</b> 11/08/2018	<b>Approved By:</b> 80240 WARREN, JOHN	<b>Date:</b> 12/18/2018
---	----------------------------	---	----------------------------



All of David Weidner's performance evaluations reflected overall marks of meets or exceeds expectations and/or standards.

**Commendation Letters:**

May 15, 2017 Letter from Defense Attorney Josh Bentley regarding Sergeant Weidner's responsiveness and professionalism.

January 9, 2017 Letter to Sheriff Carlos Bolanos from San Mateo County Superior Court Judge Lisa A. Novak, commending Sergeant Weidner and seven other San Mateo County Sheriff's Office members. The commendation from Judge Novak was a result of a jury trial in which an inmate was accused of assaulting deputies while in custody. The event was captured on surveillance video and Judge Novak wrote in her letter, "What I saw was a team of true professionals attempt to initially diffuse the situation, then ultimately restrain the inmate and come to his aid. All of your officers were highly professional and remained so during what was a volatile situation created by a very unstable individual. Even though the inmate was hostile, discourteous, violent, irrational and emotional, every member of the Sheriff's department treated him with respect in spite of the dangerous situation he created. I commend each of the following members of your department." (Followed by the list of 8 San Mateo County Sheriff's Office employees).

November 10, 2016 Appreciation letter from a former inmate in the Sheriff's Work Furlough Program.

September 23, 2016 Appreciation letter from the Drug Enforcement Agency for David Weidner's participation in Urban Shield.

September 29, 2015 Appreciation letter from the Drug Enforcement Agency for David Weidner's participation in Urban Shield.

September 12, 2014 Appreciation letter from the Drug Enforcement Agency for David Weidner's participation in Urban Shield.

August 13, 2012 Appreciation letter from a concealed weapon authorized carrier for being treated professionally by members of the San Mateo County Sheriff's Office range staff.

August 5, 2011 Appreciation letter from a community member for professional service.

April 25, 2011 and June 15, 2011

David Weidner (then Deputy Weidner) was recognized internally at a San Mateo County Sheriff's Office event and an annual Redwood City Elks Lodge public safety event for assisting

CONTROLLED DOCUMENT

Prepared By: 80202 MASSEY, BILL

Date: 11/08/2018

Approved By: 80240 WARREN, JOHN

Date: 12/18/2018





a female deliver her first child at home when dispatched to an emergency medical call for service.

June 14, 2011 Appreciation letter from a community member for professional service.

Undated, but received in 2011  
Appreciation letter from a community member for professional service.

October 6, 2010 Appreciation letter from a community member for professional service dealing with the author's mentally ill daughter. The author's daughter was diagnosed with a paranoid schizoaffective disorder. The author was appreciative of how David Weidner (then Deputy Weidner) dealt with the mentally ill daughter and she praised Deputy Weidner's "CIT", Crisis Intervention Training that she believed was attributable to how Weidner interacted with the young woman.

July 24, 2010 Appreciation letter from a concealed weapon authorized carrier for being treated professionally by members of the San Mateo County Sheriff's Office range staff.

December 28, 2009 Appreciation letter from South San Francisco Police Chief Michael Massoni for assistance with a county-wide active shooting training event.

May 6, 2010 Appreciation email from a community member regarding Neighborhood Watch.

July 1, 2009 Appreciation letter from a citizen ride-along.

May 17, 2009 Appreciation letter from a Professor from Contra Costa College for a ride-along that David Weidner facilitated.

March 31, 2008 Appreciation letter from a concealed weapon authorized carrier for being treated professionally by members of the San Mateo County Sheriff's Office range staff.

February 27, 2006 Appreciation email from a community member regarding a deceased family member and the compassion shown to the family.

February 14, 2003 Appreciation letter from Menlo Park Police Chief Christopher Boyd regarding the San Mateo County Sheriff's Office Emergency Response Team responding to the San Mateo Medical Center to transport a violent individual that had been arrested initially by the Menlo Park Police Department.

**Internal Affairs Investigations/ Complaints:**

August 29, 2012 David Weidner (then Deputy Weidner) [REDACTED]

**CONTROLLED DOCUMENT**



On November 7, 2018, I personally met with San Mateo County Sheriff's Office Professional Standards Bureau Sergeant Jon Sebring to further the process of reviewing the listed personnel files. On November 7, 2018, I reviewed the last three personnel files belonging to Deputy Alyssa Lorenzatti, Deputy John Demartini and Deputy Bryan Watt.

I have summarized my review of each Deputy's personnel file below:

**Deputy Alyssa Lorenzatti**

Deputy Lorenzatti was hired by the San Mateo County Sheriff's Office on July 31, 2016 as a Deputy Sheriff Lateral hire. Lorenzatti graduated from the (1281 hour) Basic Police Academy on October 30, 2013, while employed by the California Highway Patrol. Alyssa Lorenzatti was previously employed by the California Highway Patrol from January 24, 2013 through July 30, 2016.

Deputy Lorenzatti possesses a Bachelor's Degree in Justice Studies.

Deputy Lorenzatti possesses an Intermediate Certificate through POST/ Peace Officer Standards and Training.

All of Alyssa Lorenzatti's performance evaluations reflected overall marks of meets or exceeds expectations and/or standards.

Deputy Lorenzatti did not have any written commendations, complaints or internal affair investigations in her personnel file.

**Deputy John Demartini**

Deputy Demartini was hired by the San Mateo County Sheriff's Office on August 6, 2002 as a Deputy Sheriff Lateral hire. Demartini graduated from the (832 hour) Basic Police Academy on June 4, 1999, while employed by the San Francisco Sheriff's Department. John Demartini was previously employed by the San Francisco Sheriff's Department from March 16, 1998 through approximately August 5, 2002.

Deputy Demartini possesses an Advanced Certificate through POST/ Peace Officer Standards and Training.

[REDACTED]

**CONTROLLED DOCUMENT**

Prepared By:  
80202 MASSEY, BILL

Date:  
11/08/2018

Approved By:  
80240 WARREN, JOHN

Date:  
12/18/2018



All of the remaining performance evaluations for Deputy Demartini reflected overall marks of meets or exceeds expectations and/or standards.

**Commendation Letters:**

January 15, 2015 Appreciation letter from South San Francisco Police Chief Jeff Azzopardi for mutual aid assistance provided when South San Francisco Police Officers were fired upon.

**Internal Affairs Investigations/ Complaints:**

May 10, 2016 Deputy Demartini [REDACTED]

November 4, 2013 Deputy Demartini [REDACTED]

**Deputy Bryan Watt**

Deputy Watt was hired by the San Mateo County Sheriff's Office on May 15, 1995 as a Correctional Officer. Watt graduated from the (800 hour) Basic Police Academy on July 30, 1999. Once Bryan Watt graduated from the police academy, he was promoted from Correctional Officer to Deputy Sheriff on July 30, 1999.

Deputy Watt possesses an Associate's Degree in Science.

Deputy Watt possesses an Advanced Certificate through POST/ Peace Officer Standards and Training.

All of Bryan Watt's performance evaluations reflected overall marks of meets or exceeds expectations and/or standards, with the exception of his initial performance evaluation in 1995. [REDACTED]

Bryan Watt also withdrew from his initial Field Training Officer program in 1999, but subsequently passed the Field Training Officer program at a later date.

**Commendation Letters:**

March 27, 2012 Appreciation letter from Foster City Police Chief Craig Courtin regarding assistance provided during a residential burglary in progress that resulted in shots being fired.

September 14, 2010 Appreciation letter from California Highway Patrol Captain G.T. Hammond regarding assistance with a multi-vehicle fatal collision.

December 24, 2008 Appreciation letter from a community member regarding Deputy Watt and Deputy Grosso's response and attention to a call that involved a woman suffering from drug and mental

**CONTROLLED DOCUMENT**

Prepared By: 80202 MASSEY, BILL	Date: 11/08/2018	Approved By: 80240 WARREN, JOHN	Date: 12/18/2018
------------------------------------	---------------------	------------------------------------	---------------------



health issues.

November 7, 2005 Appreciation letter from Menlo Park Police Chief Christopher Boyd for assistance during a police officer funeral in Menlo Park.

August 16, 2002 Commendation letter from then San Mateo County Sheriff Don Horsley for a large scale response to a brush fire in Woodside.

June 20, 2002 Appreciation letter from Foster City Police Chief Randy Sonnenberg regarding mutual aid assistance provided during an armed bank robbery in Foster City.

February 25, 2002 San Mateo County Sheriff's Office Captain Commendation regarding Deputy Watt's recognition of a DUI driver driving the wrong way in his lanes of traffic and his quick decision making efforts to navigate his vehicle out of the way.

December 8, 2001 Appreciation letter from a community member regarding Deputy Watt and Deputy Smyser's response to a distressed woman and their ability to talk with her calmly on more than one occasion.

October 11, 2001 Appreciation letter from Foster City Police Chief Randy Sonnenberg regarding Deputy Watt coordinating a jail tour for members of the Foster City Police Department.

December 6, 1999 Appreciation letter from then Redwood City Police Chief Carlos Bolanos regarding Deputy Watt, Deputy Street and Deputy Titus' response to a deceased person call that was identified as the family member of a Redwood City Police Officer.

October 1998 Multiple appreciation letters from College of Notre Dame students for arranging a jail tour for an entire Human Services college level class.

August 13, 1998 Appreciation letter from San Mateo Police Chief John Stangl regarding the coordination of a jail tour for 19 Police Cadets.

July 1, 1996 Appreciation letter from Foster City Police Chief Robert Norman regarding the coordination of a jail tour for 14 citizen academy attendees.

**Internal Affairs Investigations/ Complaints:**

[Redacted text block]

**CONTROLLED DOCUMENT**

Prepared By:  
80202 MASSEY, BILL

Date:  
11/08/2018

Approved By:  
80240 WARREN, JOHN

Date:  
12/18/2018



**Disposition:**

Attach to Original Report

**CONTROLLED DOCUMENT**

Prepared By:

80202 MASSEY, BILL

Date:

11/08/2018

Approved By:

80240 WARREN, JOHN

Date:

12/18/2018





**Investigation:**

On November 2, 2018, I received five training memos from San Mateo County Sheriff's Office Professional Standards and Training Lieutenant Frank Dal Porto. The formal training memos outlined the relevant training and experience for each involved Sheriff's Office Deputy and Sergeant, based upon the training and personnel file information maintained by the San Mateo County Sheriffs' Office. I have summarized relevant portions of the training memos below:

**Deputy Joshua Wang**

July 13, 2018	Electronic Weapons Training	6 hours
March 23, 2018	Bias Based Policing Training	2 hours

Deputy Wang attended the following training while employed by the San Francisco Police Department:

October 13, 2017	Field Training Officer Training	40 hours
September 28, 2017	Crisis Intervention Training	40 hours
September 13, 2017	Tactical Lifesaver Training	8 hours
April 22, 2017	Threat Assessment/ De-escalation Strategies Training	10 hours
March 24, 2014	Critical Incidents for Patrol Training	2 hours

(Please refer to the attached formal training memos for additional courses that may or may not be relevant to this event.)

**Deputy Alyssa Lorenzatti**

April 18, 2018	Firearms/ Tactical Rifle Training	24 hours
January 31, 2018	Drug Recognition Expert Update Training	8 hours
November 16, 2017	Crisis Intervention Training	38 hours
November 10, 2017	Special Weapons and Tactics Training (completed on 11/10/2017)	80 hours
October 19, 2017	Electronic Weapons Training	4 hours
June 1, 2017	Arrest and Control Tactics Training	4 hours
April 3, 2017	Tactical Communications Training	2 hours
March 6, 2017	Electronic Weapons Training	4 hours
January 24, 2017	Firearm Training	4 hours

Deputy Lorenzatti attended the following training while employed by the California Highway Patrol:

May 28, 2016	Tactical Communications Training	2 hours
April 21, 2016	Firearm Training	4 hours
November 20, 2015	Drug Recognition Expert Update Training	8 hours

**CONTROLLED DOCUMENT**



November 19, 2015	Tactical Communications Training	2 hours
October 22, 2015	Arrest and Control Tactics Training	4 hours
June 22, 2015	Firearm Training	4 hours
October 30, 2014	Drug Recognition Expert Training	72 hours
May 15, 2014	Firearm Training	4 hours
April 24, 2014	Crisis Intervention Training	8 hours
May 10, 2013	Critical Incidents for Patrol Training	2 hours

(Please refer to the attached formal training memos for additional courses that may or may not be relevant to this event.)

**Deputy John Demartini**

April 12, 2018	Crisis Intervention Training	38 hours
February 23, 2018	Tactical Communication Training	2 hours
March 31, 2017	Bias Based Policing Training	2 hours
March 31, 2017	Arrest and Control Tactics Training	4 hours
February 17, 2017	Firearm Training	4 hours
December 23, 2016	Tactical Communication Training	2 hours
May 25, 2016	Arrest and Control Tactics Training	4 hours
March 18, 2015	Firearm Training	4 hours
December 16, 2014	Tactical Communication Training	2 hours
September 30, 2014	Firearm Training	4 hours
September 24, 2014	Firearms/ Tactical Rifle Training	24 hours
September 16, 2014	Arrest and Control Tactics Training	8 hours
December 4, 2012	Firearm Training	4 hours
October 26, 2010	Tactical Communication Training	2 hours
August 10, 2010	Arrest and Control Tactics Training	8 hours
January 20, 2010	Racial Profiling Update Training	2 hours
January 20, 2010	Tactical Communication Training	2 hours
July 14, 2008	Electronic Weapons Training	4 hours
January 30, 2003	Racial Profiling Training	5 hours
September 6, 2002	Expandable Baton Training	4 hours
August 20, 2002	Cultural Diversity Training	4 hours

Deputy Demartini attended the following training while employed by the San Francisco Sheriff's Department:

July 23, 2002	Use of Force and Driving Simulator	8 hours
April 17, 2001	Art of Verbal Control Training	8 hours
April 30, 1998	Arrest and Firearms Training	64 hours

**CONTROLLED DOCUMENT**

Prepared By:  
80202 MASSEY, BILL

Date:  
11/08/2018

Approved By:  
80240 WARREN, JOHN

Date:  
12/18/2018





(Please refer to the attached formal training memos for additional courses that may or may not be relevant to this event.)

**Deputy Bryan Watt**

October 20, 2017	Electronic Weapons Training	4 hours
March 24, 2017	Field Training Officer Update Training	24 hours
March 18, 2017	Tactical Communication Training	2 hours
January 14, 2017	Firearm Training	4 hours
August 16, 2016	Firearms/ Tactical Rifle Training	24 hours
April 18, 2016	Arrest and Control Tactics Training	4 hours
August 23, 2015	Tactical Communication Training	2 hours
July 29, 2015	Homelessness and Policing A Collaborative Approach Training	2 hours
April 24, 2015	Bias Based Policing	2 hours
March 20, 2015	Firearm Training	4 hours
January 19, 2015	Surviving Deadly Assaults Training	2 hours
May 27, 2014	Arrest and Control Tactics Training	4 hours
January 10, 2014	Tactical Communication Training	2 hours
December 4, 2013	Use of Force and Driving Simulator	8 hours
May 22, 2013	Patrol Operations/ Field Leadership Training	72 hours
September 20, 2012	Arrest and Control Tactics Training	8 hours
December 27, 2012	Tactical Communication Training	2 hours
December 13, 2011	Electronic Weapons Training	2 hours
June 6, 2011	Firearm Training	8 hours
June 25, 2010	Field Training Officer Training	40 hours
December 16, 2009	Racial Profiling Update Training	2 hours
December 16, 2009	Tactical Communication Training	2 hours
October 1, 2009	Crisis Intervention Training	38 hours
November 12, 2008	Crisis Intervention Training	8 hours
June 16, 2008	Electronic Weapons Training	4 hours
February 7, 2003	Racial Profiling Training	5 hours
July 21, 2000	Tactical Response to School and Community Violence Training	40 hours
September 9, 1999	Expandable Baton Training	4 hours
May 26, 1995	Arrest and Firearms Training	40 hours

**CONTROLLED DOCUMENT**

Prepared By:  
80202 MASSEY, BILL

Date:  
11/08/2018

Approved By:  
80240 WARREN, JOHN

Date:  
12/18/2018



(Please refer to the attached formal training memos for additional courses that may or may not be relevant to this event.)

**Sergeant David Weidner**

June 1, 2018	Firearm/ Tactical Firearm Instructor Training	40 hours
March 14, 2018	Use of Force and Driving Simulator	8 hours
November 7, 2017	Tactical Communication Training	2 hours
July 12, 2017	Chemical Agent Instructor Training	24 hours
March 17, 2017	Less Lethal Weapons Instructor Training	24 hours
February 24, 2017	Arrest Control Tactics Training	8 hours
February 3, 2017	Supervisory Course	80 hours
January 14, 2017	Firearm Training	4 hours
May 18, 2016	Firearm Instructor Update Training	24 hours
February 27, 2015	Academy Instructor Certification Training Course	40 hours
May 22, 2014	Patrol Operations/ Field Leadership Training	72 hours
May 16, 2014	Officer Safety and Field Tactics Update Training	40 hours
January 28, 2014	Less Lethal Weapons Instructor Training	16 hours
December 16, 2013	Tactical Communication Training	2 hours
November 18, 2013	Force Options Simulator Training	4 hours
June 11, 2013	Arrest Control Tactics Training	4 hours
August 14, 2012	Marking Cartridge Scenario Safety Officer Training	16 hours
June 12, 2012	Arrest Control Tactics Training	8 hours
February 21, 2012	Tactical Communication Training	2 hours
December 16, 2011	Firearms/ Tactical Rifle Training	32 hours
November 8, 2011	Electronic Weapons Training	2 hours
June 6, 2011	Firearm Training	8 hours
April 6, 2011	Active Shooter Instructor Training	24 hours
October 20, 2010	Arrest Control Tactics Training	4 hours
March 5, 2010	Officer Safety and Field Tactics	40 hours
January 20, 2010	Racial Profiling Update Training	2 hours
January 20, 2010	Tactical Communication Training	2 hours
January 20, 2010	Firearm Training	4 hours

**CONTROLLED DOCUMENT**

Prepared By:  
80202 MASSEY, BILL

Date:  
11/08/2018

Approved By:  
80240 WARREN, JOHN

Date:  
12/18/2018



November 7, 2008	Firearm Instructor Training	80 hours
October 23, 2008	Crisis Intervention Training	8 hours
August 1, 2008	Electronic Weapons Training	4 hours
November 15, 2007	Arrest Control Tactics Training	8 hours
November 1, 2007	Crisis Intervention Training	38 hours
February 7, 2003	Racial Profiling Training	5 hours
August 15, 2002	Cultural Diversity Training	8 hours
May 24, 1993	Arrest and Firearms Training	64 hours

(Please refer to the attached formal training memos for additional courses that may or may not be relevant to this event.)

**Disposition:**

Attach to Original Report

**CONTROLLED DOCUMENT**

Prepared By:  
80202 MASSEY, BILL

Date:  
11/08/2018

Approved By:  
80240 WARREN, JOHN

Date:  
12/18/2018



**Investigation:**

On November 6, 2018 at approximately 1645 hours, I received a voicemail message from Mi'trease Johnson. Ms. Johnson identified herself as the mother of Chinedu Okobi's 12 year old daughter, Christina Okobi. Johnson stated that she and Christina live in Tennessee. She wanted to inquire about aspects of the on-going investigation and about the possibility of getting certain personal items released to Christina. Johnson provided a call back phone number of (615) 589-0678.

On November 7, 2018 at approximately 0940 hours, I attempted to call Mi'trease Johnson back. There was no answer and the voicemail message was generic. I left a voicemail message asking Johnson to call me back at her convenience. During the afternoon hours of November 7, 2018, Mi'trease Johnson left me a voicemail message, asking me to call her on November 8, 2018 at approximately 3:30 pm pacific time.

I called Mi'trease Johnson on November 8, 2018 at approximately 1530 hours. I spoke with Mi'trease Johnson for approximately 34 minutes. The bulk of my conversation with Mi'trease Johnson was spent answering questions she had about the investigative process, the timing of specific findings and the release of personal property back to family members.

During the phone conversation, Mi'trease Johnson stated that Chinedu Okobi had been out to Nashville to visit with their 12 year old daughter, Christina Okobi in May of 2018, around Mother's Day. Mi'trease Johnson said that Chinedu Okobi spent a few (possibly as many as 4 days) in Nashville and that was the last time that she and Christina personally saw him.

Mi'trease Johnson said that she and Chinedu Okobi met in college and they were involved in a five year long relationship, in which Christina was born out of. Mi'trease Johnson stated that she lived in various parts of Northern California, including Pacifica, San Francisco and the East Bay, but she and Christina have lived in Nashville, TN for approximately the last eight years. Mi'trease Johnson said that Christina was Chinedu Okobi's only child.

At approximately 31:20 into the conversation, Mi'trease Johnson stated that she would let "her lawyer" speak on her behalf when deciding to provide any information about Chinedu Okobi's mental health status. I informed Mi'trease Johnson that I was unaware that she had personally retained an attorney and I was under the impression (based upon statements she made earlier in the conversation) that she had retained an attorney to represent Christina Okobi (her 12 year old daughter) in a possible civil suit. I explained to Mi'trease Johnson that if she or her attorney, whom she identified as Carl Douglas, wished to provide additional information about Mr. Okobi, they could contact me directly. Mi'trease Johnson stated that Mr. Douglas was aware that she had called the San Mateo County Coroner's Office and he was also aware that the San Mateo County Coroner's Office had directed her to call the San Mateo County District Attorney's Office.

**Disposition:**

**CONTROLLED DOCUMENT**

Prepared By: 80202 MASSEY, BILL	Date: 11/09/2018	Approved By: 80240 WARREN, JOHN	Date: 12/17/2018
------------------------------------	---------------------	------------------------------------	---------------------



**SAN MATEO COUNTY DISTRICT ATTORNEY'S OFFICE**

400 COUNTY CENTER, 3RD FLOOR REDWOOD CITY, CA 94063 650-363-4636

SUPPLEMENT 26 - Interview of Mi'trease Johnson

18-1003-02

Attach to Original Report

**CONTROLLED DOCUMENT**

Prepared By:  
80202 MASSEY, BILL

Date:  
11/09/2018

Approved By:  
80240 WARREN, JOHN

Date:  
12/17/2018





**Investigation:**

The following are summary descriptions of what is captured on the various Mobile Audio Video Units from the involved San Mateo County Sheriff's Office Patrol Vehicles as well as video obtained from Witness Garrison's cellular telephone. Associated times are approximate, based on time stamps from the MAV Units.

**Deputy Joshua Wang's Mobile Audio Video (MAV) from Vehicle #MB10:**

12:59:39: The MAV video begins with Deputy Wang making a U-turn from northbound El Camino Real (SR 82) at the intersection of Park Boulevard, to southbound El Camino Real. Deputy Wang travels southbound El Camino Real in the #3 (far right) lane.

13:00:00 Deputy Wang approaches the intersection of Capuchino Drive (Kelly Moore Paints can be seen on the right) while traveling in the #3 lane, Decedent Chinedu Okobi can be seen walking from the northwest corner of Millwood (closest to Chapel of the Highlands) across El Camino Real (eastbound). It should be noted at that intersection the pedestrian crosswalk is located on the south side of the intersection not where Decedent Okobi was entering the roadway.

The traffic signal facing Deputy Wang as he travels southbound El Camino Real at Millwood is green. As Decedent Okobi walks into lane #3, a vehicle travelling southbound in lane #2 is approaching the intersection and the vehicle's brake lights are activated. The vehicle slows but continues through the intersection and passed Decedent Okobi. Decedent Okobi continues eastbound and walks into lane #2 as the traffic light for southbound El Camino changes to yellow (13:00:03). As Decedent Okobi walks from lane #2 to lane #1 the light turns from yellow to red (13:00:06). At this point the only vehicle approaching the intersection southbound is Deputy Wang's.

13:00:09 Decedent Okobi steps onto the center median and then walks across #1,2, and 3 lane of northbound traffic which has stopped for the red traffic light. However, two vehicles enters the intersection making a left turn from Millwood onto northbound SR82, both stop for Decedent Okobi (13:00:14).

13:00:22 Deputy Wang moves into southbound lane #1, once the traffic light turns green for southbound traffic Deputy Wang makes a U-turn after activating his emergency lights.

13:00:25 Deputy Wang completes the U-turn and Decedent Okobi is walking in the northbound traffic lane #3, facing northbound, heading towards the eastern sidewalk. Decedent Okobi's route to the sidewalk was not direct but rather an angle approach across traffic lanes in a northerly direction.

**CONTROLLED DOCUMENT**

Prepared By:  
80210 RAFFAELLI, KEVIN

Date:  
11/13/2018

Approved By:  
80240 WARREN, JOHN

Date:  
12/18/2018



**CONTROLLED DOCUMENT**

- 13:00:31 Deputy Wang pulls alongside of Decedent Okobi just prior to the San Juan and SR 82 intersection. Deputy Wang lowers his window and states “Hey, hold up a minute” “Hold up a minute”. Decedent Okobi is not seen in view of the MAV but Deputy Wang does not exit his vehicle.
- 13:00:41 Deputy Wang continues northbound and pulls to the north side of San Juan and SR 82 intersection and to the curb. It sounds like Deputy Wang exits his vehicle. Stating “Hey, stop”. Traffic is moderate in both directions on SR 82 at the time.
- 13:00:47 Deputy Wang gets in his vehicle and starts to move from the curb line, but passing traffic causes him to wait.
- 13:00:59: Deputy Wang’s vehicle is angled in lane #3 of northbound SR82, facing in a slight northwestern direction. The MAV picks up Decedent Okobi as he is now in the center median walking northbound. Deputy Wang contacts County Communication over the radio and states “County, Boy 62”.
- 13:01:09 Deputy Wang starts to move his vehicle forward as Decedent Okobi walks west across northbound lanes #1, 2, and 3. Decedent Okobi reaches the western sidewalk as southbound traffic approaches the area.
- 13:01:10 Deputy Wang advises County Communications “Can you put me on a ped stop at ECR and Capuchino and can you role me one more unit please”.
- 13:01:15 Deputy Wang drives to the Capuchino and SR 82 intersection, northbound, making a U-turn, to southbound SR82.
- 13:01:26 Deputy Wang stops his vehicle and advises County Communications “and if you could send them Code 3, he’s running on ECR into traffic”. Decedent Okobi is seen moving in a southerly direction in the left turn stack lane for northbound traffic as a vehicle approaches northbound in lane #3. Decedent Okobi is looking towards Deputy Wang’s vehicle then turns and walks towards the eastern sidewalk.
- 13:01:41 Deputy Wang makes a U-turn and is now travelling northbound on SR82 at Capuchino.
- 13:01:47 Deputy Wang appears to be in the process of making another U-turn onto southbound SR82 at the same location when Decedent Okobi is seen running at the Capuchino and SR 82 intersection, northbound, across the southbound #2 and #3 lane of traffic. Several vehicles southbound on SR82 have to stop to avoid striking decedent Okobi.

Prepared By:  
80210 RAFFAELLI, KEVIN

Date:  
11/13/2018

Approved By:  
80240 WARREN, JOHN

Date:  
12/18/2018





**CONTROLLED DOCUMENT**

- 13:01:55 Deputy Wang turns into the southbound lanes and drives northbound until he reaches the Santa Helena intersection where he makes a U-turn and heads back southbound on SR82. Deputy Wang advises County Communications “he’s on foot, I am just paralleling him on ECR, he’s a BMA about 6 feet tall, 220 pounds wearing a blue and black stripe shirt, still walking in traffic”.
- 13:02:22 Deputy Wang makes a U-turn again at the Santa Helena intersection, facing northbound in the northbound lanes. Several vehicles are in traffic lanes stopped. Deputy Wang advises County Communications “he’s still northbound ECR, we’re at Santa Helena, he’s still running in traffic” (no visual of decedent Okobi).
- 13:02:40 Deputy Wang is northbound SR82 just north of Santa Helena, decedent Okobi is seen on the center median walking northbound. Decedent Okobi then turns and starts to walk south.
- 13:02:50 Deputy Wang exits his vehicle, a muffled voice possibly the decedents states “what”, to which Deputy Wang replies “let’s come over here and talk on the sidewalk”.
- 13:03:00 Deputy Wang gets back into his car and accelerates north bound on SR82, Deputy Wang advises County Communications “still walking northbound ECR”
- 13:03:23 Deputy Wang drives to Park Boulevard and makes a U-turn, he advises over the radio “Unit coming northbound ECR he on the median at ECR”.
- 13:03:35 Deputy Wang is now travelling southbound on SR82 from Park Boulevard, as he proceeds the sound of emergency vehicle sirens are heard over the MAV.
- 13:03:38 A marked San Mateo County Sheriff’s Department vehicle is visible, pulling across the southbound lanes of SR82 in a northerly direction and stopping at the curb line, south of Capuchino, Decedent Okobi is seen walking on the western sidewalk southbound approaching the Union Bank, several yards away from the responding deputy.
- 13:03:45 Two additional Sheriff’s Department vehicles cross from northbound lanes into southbound lanes and towards the curb line, in order to intercept Decedent Okobi.
- 13:03:49 Decedent Okobi continues to walk southbound and is raising his hands, while he is holding what appears to be a leather briefcase in his right hand, and a backpack on his back.
- 13:03:51 Deputy Alyssa Lorenzatti approaches Decedent Okobi from the south and is pointing

Prepared By:  
80210 RAFFAELLI, KEVIN

Date:  
11/13/2018

Approved By:  
80240 WARREN, JOHN

Date:  
12/18/2018



**CONTROLLED DOCUMENT**

towards Decedent Okobi stating "Get down on the ground". Decedent Okobi continues to walk southbound, walking past Deputy Lorenzatti as Deputy Lorenzatti reaches to grab Decedent Okobi's left hand. Decedent Okobi moves his hand to resist her grabbing it.

13:03:57 Deputy Wang and Deputy DeMartini run to assist Deputy Lorenzatti. Decedent Okobi raises his hands and continues to walk away.

13:04:02 Deputy Lorenzatti grabs the Decedents arm and states "Stop resisting". Deputy Wang states "You are going to get Tased, get on the ground, now!" A struggle ensues between the Deputies and Decedent Okobi. Due to the distance of the MAV camera it is difficult to see who is grabbing the decedent Okobi but Decedent Okobi is resisting their efforts and is trying to pull away from the deputy's control.

13:04:05 Decedent Okobi backs onto the street while a deputy holds onto his jacket arm, stretching the jacket arm until the jacket comes off of Decedent Okobi.

13:04:13 Decedent Okobi frees himself from deputies grip and turns to run southbound SR82 in the southbound lane #3. At which time Deputy Wang fires his Taser at Decedent Okobi. Decedent Okobi is seen falling forward on the ground. A deputy is yelling "on the ground, get on the ground".

13:04:17 Decedent Okobi is on his back with legs and arms extended. Deputy Wang advises County Communications "Give me a Code 33, we have a Taser deployment". Deputies are giving Decedent Okobi commands "role over on your stomach, now" several deputies are giving the same commands.

13:04:30 Deputy Wang advises over radio "second Taser deployment". Decedent Okobi is on his back but is not complying with deputy's orders to roll onto his stomach.

13:04:40 Decedent Okobi is yelling, stating "what did I do", Deputy Wang gives a command "I am going to Tase you again if you do not roll over on your stomach". Continual commands are being given to Decedent Okobi, Decedent Okobi does not appear to be following the commands. Decedent Okobi yells each time he is Tased.

13:04:47. Deputy advises over the radio "Still resisting, third Taser deployed". Commands are being given to Decedent Okobi, to roll over, to which he does not reply to. Deputies begin to grab at Decedent Okobi. Decedent Okobi continues to resist their attempt to control him and moves his arms away from their reach.

13:05:10 Deputies continue to give Decedent Okobi commands, Decedent Okobi yells back "get

Prepared By:  
80210 RAFFAELLI, KEVIN

Date:  
11/13/2018

Approved By:  
80240 WARREN, JOHN

Date:  
12/18/2018



them off me” several times, possibly referring to the Taser barbs. Deputy Wang’s advises County Communications “Boy 62, he’s still resisting”.

13:05:17 Decedent Okobi gets up and turns away from deputies as he attempts to flee. Decedent Okobi falls to the ground (unknown if Taser activated). Commands are being given by various deputies for Decedent Okobi to turn onto his stomach. Deputy Watt extends his collapsible baton but does not strike Decedent Okobi.

13:05:31 Decedent Okobi again tries to get up, and again he falls to the ground (Unknown if Taser activated). Deputy Wang advises County Communications “Boy 62, can you roll medical”.

13:05:35 Decedent Okobi stands up and starts to jog away from the deputies, east across the south and northbound lanes of SR82 with deputies following. The Taser can be heard activating, based on the sound of the activation it was apparent that the Taser was no longer fully connected to Decedent Okobi. A deputy states “Turn the Taser off”.

13:05:56 Although, out of MAV view deputies are heard issuing orders to Decedent Okobi, advising him to get on the ground. The sound of a struggle and grunting can be heard but no visual of the struggle can be seen on Deputy Wang’s MAV.

13:06:15 Deputy states, “Stop resisting now” another deputy states “Stay on top of him”, then “give me your hand”.

13:07:00 Decedent Okobi still not under control, deputy is stating “handcuff him”.

At this point the audio portion is intermittent on Deputy Wang’s MAV.

13:12:35 Fire arrives on scene.

13:14:00 Medics arrive on scene

13:17:00 Second Medic Unit arrives

13:17:45 Second Fire Unit arrives

**End**

**Sergeant David Weidner Mobile Audio Video (MAV) from vehicle MB1:**

**CONTROLLED DOCUMENT**

Prepared By:  
80210 RAFFAELLI, KEVIN

Date:  
11/13/2018

Approved By:  
80240 WARREN, JOHN

Date:  
12/18/2018



**CONTROLLED DOCUMENT**

13:03:54 Sergeant Weidner arrives at scene (northbound in the southbound #3 lane of SR82. Decedent Okobi is on the west sidewalk walking south, Decedent Okobi has his hands out away from his body and then raises them up over his head. Deputy Lorenzatti is approaching the decedent Okobi on foot and grabs for Decedent Okobi's left hand but Decedent Okobi pulls away. Deputy Wang and Deputy DeMartini run to Deputy Lorenzatti's assistance.

13:04:05 Deputy Lorenzatti's patrol vehicle is parked to the front and left of Sergeant Weidner's vehicle and is limiting the MAV view of what is occurring on the sidewalk.

13:04:10 Sergeant Weidner runs to assist, as Decedent Okobi frees himself from contact with the other deputies. Decedent Okobi starts to run away with Deputy Wang several steps behind him. Decedent Okobi then turns and runs towards Deputy Wang and Deputy Wang points his Taser at Decedent Okobi. Decedent Okobi continues to run towards Deputy Wang as Deputy Wang backs up. Decedent Okobi raises his hands towards Deputy Wang at which time Deputy Wang fires his Taser at Decedent Okobi. Decedent Okobi takes a few steps towards Deputy Wang and then steps away and falls to the ground. The deputies are ordering Decedent Okobi to roll onto his stomach.

Sergeant Weidner and Deputy Lorenzatti have their Tasers out as they order Decedent Okobi to roll over (onto his stomach). Deputy Lorenzatti holsters her Taser and attempts to place a control hold on Decedent Okobi's right hand, unsuccessfully. She then moves to Decedent Okobi's left hand. Deputy Lorenzatti attempts to move Decedent Okobi onto his stomach, as Sergeant Weidner and Deputy DeMartini try and control Decedent Okobi legs. Decedent Okobi breaks free of Deputy Lorenzatti's hold and kicks at Sergeant Weidner and Deputy DeMartini causing them to move back.

13:04:25 Deputy Wang orders Decedent Okobi to roll over and warns him of another Taser activation. Deputy Wang then appears to activate the Taser a second time.

13:04:33 Decedent Okobi is on his back and the deputies are continuously ordering him to roll over. Decedent Okobi yells "what I do". Sergeant Weidner states "Sir, roll over on your stomach". The deputies again give Decedent Okobi commands to get on his stomach. Decedent Okobi fails to comply and kicks towards the deputies. Deputy Wang appears to activate the Taser for a third time (13:04:40).

13:04:48 Decedent Okobi states "get them off me" (referring to the Taser barbs). Sergeant Weidner grabs Decedent Okobi's left arm and tells him to "relax man" as Deputy DeMartini grabs Decent Okobi's left leg. Decedent Okobi continues to move and Deputy DeMartini releases.

Prepared By:  
80210 RAFFAELLI, KEVIN

Date:  
11/13/2018

Approved By:  
80240 WARREN, JOHN

Date:  
12/18/2018





**CONTROLLED DOCUMENT**

- 13:04:57 Sergeant Weidner tells Decedent Okobi that he will remove the barbs if he rolls onto his stomach. Sergeant Weidner continues to state he will “take these out” (referring to the barbs) if Decedent Okobi rolls onto his stomach.
- 13:05:11 As Sergeant Weidner tells Decedent Okobi that he will remove the barbs, Decedent Okobi begins to sit up and get up off of the ground. The deputies tell Decedent Okobi to remain on the ground.
- 13:05:16 As Decedent Okobi gets to his feet and takes a step Deputy Wang appears to activate his Taser a fourth time and Decedent Okobi again falls to the ground, however, the Taser is making an arcing sound which suggests incomplete contact. Decedent Okobi states “somebody help me”. The deputies continue to order Decedent Okobi to roll onto his stomach.
- 13:05:24 Decedent Okobi gets to his feet again but falls to the ground and yells “somebody help me”. This appears to be when Deputy Wang activated his Taser a fifth time, but again the Taser is making an arcing sound which suggests incomplete contact.
- 13:05:33 Decedent Okobi gets to his feet, Deputy Wang removes and expands his collapsible baton Deputy Watt also has expanded his collapsible baton.
- 13:05:36 Decedent Okobi starts to jog eastbound across SR82. Deputy Wang has activated the Taser a sixth time but is has no effect and Decedent Okobi continues to move away. Again the Taser is making an arcing sound which suggests incomplete contact.
- 13:04:48 Decedent Okobi and the deputies are out of view of the MAV, however, the sound is still working. A seventh Taser activation is heard and orders are given to Decedent Okobi to get on the ground. Sergeant Weidner tells Deputy Wang to turn the Taser off. (Based on the noise the Taser was emitting it appears that activation four, five, six and seven were ineffective possibly due to a barb being dislodged).
- 13:06:07 Sergeant Weidner requested via County Communications additional “Code 3 cover” units.
- 13:06:18 Sergeant Weidner tells the deputies “stay on top of him, stay on top of him, watch out he’s bleeding”. Sergeant Weidner continues to tell Decedent Okobi to give him his hands. Sergeant Weidner asks for handcuffs. A deputy states “I’m out” another deputy states “I can’t see”. Sergeant Weidner states several times “stay in this, stay in it”.

Prepared By:  
80210 RAFFAELLI, KEVIN

Date:  
11/13/2018

Approved By:  
80240 WARREN, JOHN

Date:  
12/18/2018



CONTROLLED DOCUMENT

- 13:07:30 Based on Sergeant Weidner’s demeanor it sound as though Decedent Okobi is handcuffed.
- 13:07:52 Sergeant Weidner states “watch for positional asphyxia”.
- 13:08:02 Sergeant Weidner advises County Communications to have Medics respond “Code 3”.
- 13:08:30 Sergeant Weidner advises County Communications “subject is 11-5, several Taser deployments, pepper spray deployment, I think I may have a few deputies hurt”.
- 13:08:50 Sergeant Weidner states to the deputies “watch his breathing”, a deputy states “you alright” “he’s still breathing”.
- 13:09:25 Sergeant Weidner states “sit him up”.
- 13:09:55 Sergeant Weidner states “you okay” “you alright” Deputy Wang asks County Communications “Confirm we have Medics coming Code 3”.
- 13:10:00: Sergeant Weidner tells a deputy “take his pulse”.
- 13:11:38 Sergeant Weidner states “is he okay, is he okay” “check his pulse”.
- 13:12:30 Sergeant Weidner is speaking to someone and states “dudes alive, that’s all you need to know, we’re good”.
- 13:13:48 Sergeant Weidner states “I need you to check his pulse to make sure he is good to go”.
- 13:17:25 Either Fire or Medic personnel advise Sergeant Weidner “we need to go”, Sergeant Weidner tells a deputy “we need to follow him”.
- 13:17:50 Unknown person states “We need a monitor on him right now”, Sergeant Weidner repeats the request.

End

**Deputy DeMartini’s Mobile Audio Video (MAV) from Vehicle #SO16:**

13:03:48 Deputy DeMartini arrives on scene, pulls his patrol vehicle in a westerly direction across the southbound lanes of SR82. Decedent Okobi is walking on the sidewalk, on west side of SR82. Decedent Okobi raises his left hand and makes a stop motion towards Deputy

Prepared By:  
80210 RAFFAELLI, KEVIN

Date:  
11/13/2018

Approved By:  
80240 WARREN, JOHN

Date:  
12/18/2018



DeMartini as Deputy DeMartini stops his patrol vehicle. Deputy Wang pulls to a stop from southbound SR82.

No audio from Deputy DeMartini's MAV unit. No video of the incident, except above, is visible.

**Deputy Brian Watt's Mobile Audio Video (MAV) from Vehicle #SO37:**

13:04:14 Deputy Watt arrives on scene. Decedent Okobi is already on his back on the ground, Deputy Lorenzatti's patrol vehicle is blocking the MAV view of the incident.

There is no MAV audio and Deputy Watt's video captures partial movement of the deputies and Decedent Okobi which was previously captured by Sergeant Weidner's MAV.

13:05:35 Deputies and Decedent Okobi move out of MAV visual range.

**End**

**Deputy Lorenzatti's Mobile Audio Video (MAV) from Vehicle MB8:**

13:03:38 Deputy Lorenzatti arrives on scene as Decedent Okobi is walking on the west sidewalk of SR82. Deputy Wang's patrol vehicle is seen in the distance in lane #3 of SR82 southbound approaching. Deputy Lorenzatti approaches Decedent Okobi from the south on foot and prior to reaching him Deputy DeMartini and Deputy Wang pull their patrol vehicles to a stop nearby.

There is no audio associated with

13:03:55 Decedent Okobi continues to walk towards Deputy Lorenzatti, he raises his hands upward, then puts them to his side. Deputy Lorenzatti attempts to grab Decedent Okobi's left arm in a control hold but Decedent Okobi pulls it away.

13:05:58 Deputy Lorenzatti follows Decedent Okobi, at which time Deputies DeMartini and Wang run to assist her. The deputies try and grab Decedent Okobi. Decedent Okobi struggles and breaks free. Deputy DeMartini holds onto Decedent Okobi's left jacket sleeve. Decedent Okobi continues to resist and pulls away, as he does his jacket comes off. Sergeant Weidner arrives.

**CONTROLLED DOCUMENT**

Prepared By:  
80210 RAFFAELLI, KEVIN

Date:  
11/13/2018

Approved By:  
80240 WARREN, JOHN

Date:  
12/18/2018





13:04:09 Decedent Okobi takes several steps moving away from the deputies then turns towards Deputy Wang and runs towards him. Deputy Wang has his Taser pointed towards Decedent Okobi, Decedent Okobi runs towards Deputy Wang while reaching out with his right hand and slapping at the Taser. Deputy Wang moves back to avoid having the Taser hit out of his hand and discharges his Taser at Decedent Okobi. Decedent Okobi falls to the ground after taking a few steps away from Deputy Wang.

13:04:21 Decedent Okobi and deputies are now out of the MAV field of view.

**End**

**Sergeant Irfan Zaidi Mobile Audio Video (MAV) from vehicle T5:**

13:12:07 Sergeant Zaidi arrives on scene (No audio). Video is partially restricted due to a parked vehicle in front of Sergeant Zaidi's vehicle. Video captures partial view of Deputies who appear to be bracing Decedent Okobi in a seated position.

13:13:59 AMR arrives on scene, medics move gurney and equipment towards decedent Okobi.

13:17:01 Vehicle which blocked video moves. Video now captured Decedent Okobi. Decedent Okobi is in seated position, medics are checking on him.

13:17:34 Decedent Okobi is laid on his back by medics.

13:17:56 Medic begins chest compressions on Decedent Okobi, start live savings measures.

13:28:00 Decedent Okobi placed on gurney.

13:28:14 Decedent Okobi placed in AMR for transport.

13:30:00 AMR leaves with Decedent Okobi.

**End**

**Citizen Garrison's cellular telephone video:**

**CONTROLLED DOCUMENT**

Prepared By:  
80210 RAFFAELLI, KEVIN

Date:  
11/13/2018

Approved By:  
80240 WARREN, JOHN

Date:  
12/18/2018



Six videos were taken by Garrison. There are no time stamps on the video. The following is in a narrative format for each video. Audio on the video is from Garrison and his co-workers inside of the location, audio from deputies and decedent is muffled or not captured. Garrison is videoing the incident from inside of the Tri Counties Bank which is located at 1551 El Camino, located on the west side of SR82 directly next to where Decedent Okobi is resisting the deputies.

Image 3665 (34 seconds) Decedent Okobi is on the ground, laying on his back near the right front quarter panel of Deputy Lorenzatti's patrol vehicle. Deputy Lorenzatti and Sergeant Weidner are standing near him. Deputy Wang's right arm holding the Taser is visible. The Taser has been deployed. Deputies Watt and DeMartini come into view.

Decedent Okobi is resisting the deputies' attempts to grab onto his arms and legs, by swinging his arms and kicking with his legs. It appears that one of the Taser barbs is logged into Decedents right hand.

Image 3666 (74 seconds) Decedent Okobi is still on his back and is still struggling against the deputies. The deputies are attempting to control Decedent Okobi's arms/hands but Decedent Okobi continues to resist.

Decedent Okobi gets to his feet and then takes a few steps before falling down. Deputy Watt grabs his ASP and extends it, but does not strike. It appears as through Decedent Okobi is on the ground but the view is obscured by the patrol vehicle they are behind.

Witness Garrison moves his position to a window further south of his original location.

Decedent Okobi is now standing and is jogging east across lanes #3, 2, and 1 of southbound SR82, and Lane #1, 2, and 3 of northbound SR82. All deputies are following him. Deputy Wang has taken out his ASP and extended it.

Witness Garrison moves his position to a window further south.

Decedent Okobi stops and turns to face the deputies, he appears to be in a northbound traffic lane. Decedent Okobi is backing up but remains facing the deputies. Deputy Wang appears to attempt to strike Decedent Okobi with a baton strike, Decedent Okobi counters with a right hand punch to the left side of Deputy Wang's face, knocking him back. Decedent Okobi moves farther south and east

CONTROLLED DOCUMENT

Prepared By: 80210 RAFFAELLI, KEVIN

Date: 11/13/2018

Approved By: 80240 WARREN, JOHN

Date: 12/18/2018



with deputies following and out of view of Garrison. A San Mateo County Sheriff's Office Community Safety Officer arrives and tries to assist the deputies. Only two or three deputies are now in view.

Garrison 'pans the video to the right', Decedent Okobi is now on the ground and the deputies are attempting to hold him down.

Image 3667 (26 seconds) Decedent Okobi is on the ground and the deputies are wrestling with him. (Cars are driving by which limits the view of Garrison video).

Image 3668 (49 seconds) Decedent Okobi is on the ground and the deputies appear to be in the process of handcuffing him. Decedent Okobi is now handcuffed.

Image 3669 (52 seconds) Decedent is placed in a seated position on the ground. Sergeant Weidner looks at Decedent Okobi's face several times.

Image 3670 (9 seconds) Medics are now on scene and are checking Decedent Okobi, who is still seated.

**Disposition:**  
Attach to Original Report

CONTROLLED DOCUMENT

Prepared By:  
80210 RAFFAELLI, KEVIN

Date:  
11/13/2018

Approved By:  
80240 WARREN, JOHN

Date:  
12/18/2018



BACKGROUND INFORMATION

This supplemental report documents information learned by the District Attorney's Office about Chinedu Okobi's background. The areas covered by the background include biographical information, education, medical history, social media presence, criminal history, mental health and medical history, employment and information provided by his family members.

Social Media Footprint

Twitter: <https://twitter.com/donveezy03>

This Twitter account depicts OKOBI's face in the profile photo, a link to his on-line business and shows only three tweets, the last of which occurring on April 16, 2017. OKOBI's tweets are general in nature and only discuss setting up his account, setting personal goals and celebrating Easter Sunday.

LinkedIn: N/A

Facebook: <https://www.facebook.com/cvokobi> (last post occurred on August 19, 2018)

This Facebook account depicts OKOBI in the profile photo. The account shows numerous photos of OKOBI as well as videos of him rapping about Christianity. Essentially, OKOBI would include "selfie" style photos of himself, photos of animals or photos of him with other family members. With respect to his posted videos, they would be videos recorded inside of his home or vehicle using a spoken word style to rap or sing about Jesus Christ's influence within his life and the world around him.

Instagram: <https://www.instagram.com/chineduokobi/> (no activity) OKOBI's Instagram account is active. It has nine followers and it is not following any other accounts and did not post any pictures or videos. There is no profile photo assigned to this account.

YouTube: <https://www.youtube.com/channel/UC8kNkM2dKgov4heIzF-F\_EQ>

CONTROLLED DOCUMENT



This account depicts OKOBI in the profile photo. The account has only one upload from December of 2017, which shows OKOBI rapping a song called "Purple Heart."

Personal Website: <<http://www.nobleapostleministry.org/home.html>> . This website has since been taken down, however, I was able to view it for a period of time. The website was a Christian website that encouraged people to seek guidance from Christ and to use his teachings in their lives. The website also encouraged people to visit the ministry. Although the website is no longer active, it is still listed in a Google search. According to a Google search, the contact address for this ministry is 1818 Corsicana Avenue. Dallas Texas, 75201. There is also contact information for OKOBI, a phone number of [REDACTED] and an address of [REDACTED]

**Law Enforcement Contacts**

[REDACTED]  
[REDACTED] [REDACTED] [REDACTED]  
[REDACTED]  
[REDACTED]

[REDACTED] [REDACTED]  
[REDACTED]  
[REDACTED]  
[REDACTED]

[REDACTED]  
[REDACTED] [REDACTED]  
[REDACTED]  
[REDACTED]  
[REDACTED] [REDACTED] [REDACTED]  
[REDACTED]

CONTROLLED DOCUMENT

Prepared By:  
80259 HAGGARTY, JAMES

Date:  
11/13/2018

Approved By:  
80240 WARREN, JOHN

Date:  
12/18/2018



**SAN MATEO COUNTY DISTRICT ATTORNEY'S OFFICE**

400 COUNTY CENTER, 3RD FLOOR REDWOOD CITY, CA 94063 650-363-4636

SUPPLEMENT 28 - Background of Decedent Chinedu Okobi

18-1003-02

**CONTROLLED DOCUMENT**

[Redacted content]

Prepared By:  
80259 HAGGARTY, JAMES

Date:  
11/13/2018

Approved By:  
80240 WARREN, JOHN

Date:  
12/18/2018



**SAN MATEO COUNTY DISTRICT ATTORNEY'S OFFICE**

400 COUNTY CENTER, 3RD FLOOR REDWOOD CITY, CA 94063 650-363-4636

SUPPLEMENT 28 - Background of Decedent Chinedu Okobi

18-1003-02

[REDACTED]

[REDACTED]

[REDACTED]

[REDACTED]

[REDACTED]

[REDACTED]

[REDACTED]

**CONTROLLED DOCUMENT**

Prepared By:  
80259 HAGGARTY, JAMES

Date:  
11/13/2018

Approved By:  
80240 WARREN, JOHN

Date:  
12/18/2018





CONTROLLED DOCUMENT

[Redacted text block]

[Redacted text block]

[Redacted text block]

[Redacted text block]

[Redacted text block]

Medical and Psychological Information

Prepared By: 80259 HAGGARTY, JAMES

Date: 11/13/2018

Approved By: 80240 WARREN, JOHN

Date: 12/18/2018





**SAN MATEO COUNTY DISTRICT ATTORNEY'S OFFICE**

400 COUNTY CENTER, 3RD FLOOR REDWOOD CITY, CA 94063 650-363-4636

SUPPLEMENT 28 - Background of Decedent Chinedu Okobi

18-1003-02

**CONTROLLED DOCUMENT**

[REDACTED]

[REDACTED]

[REDACTED]

[REDACTED]

[REDACTED]

[REDACTED]

[REDACTED]

Prepared By:  
80259 HAGGARTY, JAMES

Date:  
11/13/2018

Approved By:  
80240 WARREN, JOHN

Date:  
12/18/2018



**SAN MATEO COUNTY DISTRICT ATTORNEY'S OFFICE**

400 COUNTY CENTER, 3RD FLOOR REDWOOD CITY, CA 94063 650-363-4636

SUPPLEMENT 28 - Background of Decedent Chinedu Okobi

18-1003-02

**CONTROLLED DOCUMENT**

[REDACTED]

- [REDACTED]
- [REDACTED]
- [REDACTED]
- [REDACTED]
- [REDACTED]
- [REDACTED]
- [REDACTED]
- [REDACTED]

[REDACTED]

[REDACTED]

[REDACTED]

[REDACTED]

[REDACTED]

Prepared By:  
80259 HAGGARTY, JAMES

Date:  
11/13/2018

Approved By:  
80240 WARREN, JOHN

Date:  
12/18/2018



**Education**

2002 B.S. Degree from Morehouse College (double major in business and economics)

**Employment**

Linked to OKOBI's twitter account is a web link to an online company called "Premier Wealth Systems" <<http://www.premierwealthsystems.com/mysite/Donveezy/home.php?d>>= . The home page for this website lists OKOBI's name, a phone number of [REDACTED] and an e-mail address of [REDACTED]

The home page also includes a video of the Premier Wealth System business model. The video illustrates a pyramid model of generating residual commissions.

When you query OKOBI's e-mail address of [REDACTED] through the Internet, you can locate another web link to a different on-line business called "Alliance Consulting Solutions" <<http://www.tigervizioninc.com/home.html>> . The "contact us" function of this webpage lists OKOBI's name, e-mail address, home address of [REDACTED] and a phone number of [REDACTED] .

In 2013, OKOBI worked at Burlington Coat Factory in Daly City (see OKOBI declaration)

**Family**

OKOBI's parents are both Nigerian and currently live in the Bay Area. When OKOBI was nine-years-old, his parents divorced. OKOBI is the youngest of six children, all of whom are college educated. OKOBI's mother worked as a nurse and his father is a minister.

OKOBI has a twelve-year-old daughter named, [REDACTED] who lives in Tennessee with her mother, Mi'trease Johnson. OKOBI and Mi'trease dated while they both attended Morehouse College.

CONTROLLED DOCUMENT



On November 16, 2018, DAI Maher and I met with OKOBI’s mother, Maureen Okobi, his sister Ebele Okobi, additional extended family members and the Okobis’ counsel. Ebele responded to questions asked about OKOBI’s background. Most of Ebele’s responses coincided with the information above. However, Ebele did provide additional information, regarding OKOBI’s background as noted below:

- \* OKOBI was born at San Francisco Children’s Hospital.
- \* OKOBI liked to write poetry and participated in “spoken word” performances.
- \* Prior to his first episode of mental illness, OKOBI was preparing to take the GMAT for graduate school.
- \* After his first known episode of mental illness, that occurred within the Morehouse library, OKOBI was taken to a hospital in Atlanta for treatment.
- \* Ebele stated that OKOBI struggled to have his mental illness properly diagnosed. In fact, Ebele advised it took OKOBI years to be have access to the right medication but when he did, he stopped “hearing voices” from inside of his head.
- \* Ebele advised that proper medical assessments and medication was obtained by OKOBI through the Pathways program. Ebele noted that while this medication was effective in assisting with OKOBI’s mental health issues, it also removed his ambitious nature.

Ebele advised that OKOBI did not attend the annual family holiday event in December of 2017. Ebele stated that OKOBI's absence indicated to the family that he may have stopped taking his medication as it was very unusual for him to miss such an event. Ebele went on to say her contact with OKOBI after December of 2017 was seldom. Ebele’s mother, Maureen, advised she last communicated with OKOBI several weeks prior to his death. During this communication they exchanged pleasant text messages between the two of them and she did not suspect anything was amiss.

When asked if any of the family members knew why OKOBI was in Millbrae on the day he died, no one could provide a reason why. Ebele suggested OKOBI may have been in Millbrae trying to obtain some sort of social service. Ebele explained that after OKOBI died, she received a call from someone who works at the Daly City Community Service Center:

**CONTROLLED DOCUMENT**

Prepared By: 80259 HAGGARTY, JAMES	Date: 11/13/2018	Approved By: 80240 WARREN, JOHN	Date: 12/18/2018
---------------------------------------	---------------------	------------------------------------	---------------------



[http://www.dalycity.org/residents/community\\_service\\_center.htm](http://www.dalycity.org/residents/community_service_center.htm)

The Service Center employee recognized OKOBI's name from the news reports of his death and contacted Ebele to inform her that OKOBI had been a current client of theirs. Ebele stated this employee advised her that OKOBI had used the Service Center for housing purposes as well as a assistance in getting back on his medication.

The interview with the Okobi family ended with Ebele stating her brother had a very strong fear of law enforcement and was terrified of getting into trouble. When asked to elaborate as to why OKOBI had a fear of law enforcement, Ebele stated OKOBI didn't suffer any specific incident, or triggering event, to cause him fear. She added that he was a large statured African American male living in the United States, so it was natural for him to be fearful of the police.

**Daly City Service Center**

[REDACTED]

**Military**

OKOBI did not serve in the military.

CONTROLLED DOCUMENT





**SAN MATEO COUNTY DISTRICT ATTORNEY'S OFFICE**

Page 1

400 COUNTY CENTER, 3RD FLOOR REDWOOD CITY, CA 94063 650-363-4636

SUPPLEMENT 29 - Secondary Download of Deputy Wang's Taser

18-1003-02

See PDF Attachment Labeled: "Taser Explanation and Pulse Graph Analysis"

**CONTROLLED DOCUMENT**

Prepared By:

80251 DECKER, RICK

Date:

11/13/2018

Approved By:

80240 WARREN, JOHN

Date:

12/18/2018

## Purpose

The purpose of this supplemental report is to summarize the operation of the *Axon Enterprise Inc.* - Taser X26P and the examination of the evidentiary data retained by the actual device deployed by Deputy Wang in this incident.

## For Reference

For reference in this report, “electricity” is the flow of electrons through a conductor, such as a wire. This concept is best understood when compared to water flowing through a pipe. The water pressure in the pipe is comparable to the **voltage, or volts**. The actual volume of water flowing through the pipe is similar to the **amperes, or amps**. Then to calculate **wattage, or watts**, one would multiply volts to amps which equals a measure of how much power the circuit can deliver in one second. For example, this is similar to when a flow of water is routed to turn a mill wheel or turbine, whereby a small volume and flow of water would turn the wheel much slower than a larger and faster volume flow.

## The Taser X26P – Use and Operation

The Taser Conductive Energy Weapon (CEW) used in this incident by Deputy Wang was a **Taser X26P**, a law enforcement specific CEW produced by Axon Enterprise Inc. When deployed, the weapon is held and aimed similar to a firearm and is equipped with a thumb safety, trigger, and sighting mechanism which includes a red LED “laser” for sight aiming and 2 low intensity white LEDs for illumination. The device is armed by attaching a cartridge to the end of the barrel that contains two sharp metal probes that once propelled by a pull of the trigger, can deliver a charge to the target that can potentially cause neuro-muscular incapacitation, depending on extenuating circumstances, to be described later in this report.



## TASER X26P



© 2018 Axon Enterprise, Inc

Once the Taser X26P is armed with a fresh cartridge, the user deactivates the thumb safety, aims the device at the target subject, and pulls the trigger to propel the probes, which can be deployed to a maximum of 25 feet. Once the probes are deployed, a second pull of the trigger will merely send another charge into these same probes. In both cases, if the trigger is pulled and released, the device defaults to a 5 second activation, which can be shortened if the manual thumb safety is activated. If the user instead holds down the trigger, the device will continue to charge until the trigger is released, allowing for an extended activation. *(For clarification, this incident does NOT include any such activation in that only deployments of 5 seconds or less occurred during the altercation.)*

The probes themselves have sharp barbed tips designed to penetrate the outer surface of the target and remain intact as the charge is delivered. The charge from the Taser is ONLY delivered if BOTH probes are connected, which completes the circuit as the charge “arcs” between the probes, completing the “loop” formed by both probes being connected to the target and their wires still being connected to the cartridge on the Taser. The electrical charge delivered by the Taser X26P is approximately .0012 amperes. For a frame of reference, a standard wall outlet delivers 16 amperes while a common C7 Christmas tree bulb requires just 1 ampere to illuminate.

## TASER Smart Probe

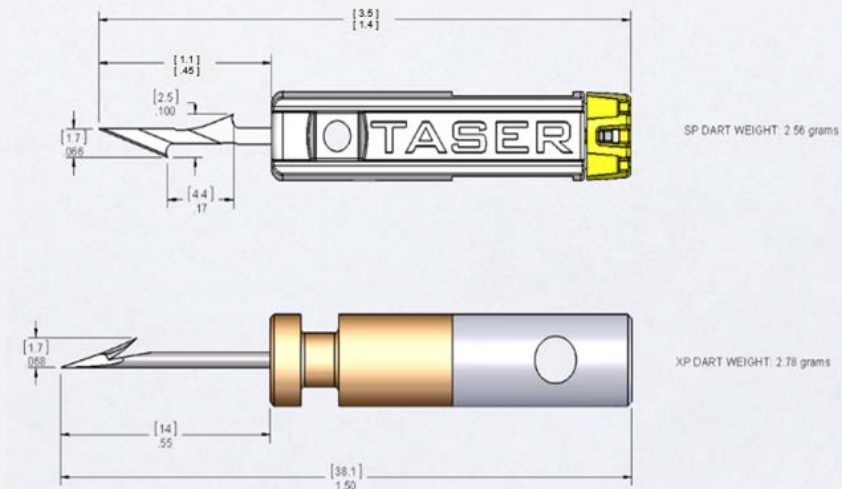

© 2018 Axon Enterprise, Inc.

## Arcing Probes

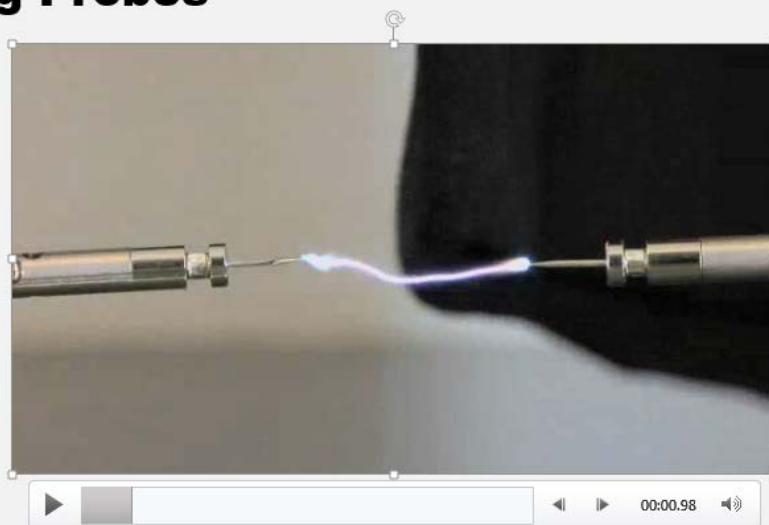

© 2018 Axon Enterprise, Inc.

The probes are deployed from the device whereby the top probe is propelled parallel to the top of the Taser and the bottom probe is propelled at an 8 degree downward angle. The greater the distance or “spread” between the two probes upon contact, the greater the surface area between the probes, thus increasing the chance that the charge will cause Neuro-muscular Incapacitation (NMI), or “body lock up”. However, it’s important to note that the charge travels or “arcs” only

between the connected probes and the path of that arc can be adversely affected by thick clothing, poor probe contact, etc. For instance, the charge can potentially arc through a thick cotton jacket while the target subject himself feels little or no effects from the charge. The fact that the arcing of the charge only travels between the probes is why additional persons can safely touch the target subject WHILE he or she is being Tased and not feel the effects of the Taser, unless they inadvertently touch the probes or the wires. This fact is also why a subject can maintain control and/or use of any limbs that are NOT affected by the Taser while being Tased, especially in the case of an up close encounter deployment that results in a short spread and typically no NMI. Thus the most effective deployment range of a Taser X26P is reported to be 14 to 25 feet, allowing for a sufficient spread between the probes most likely to cause NMI once the circuit is complete.

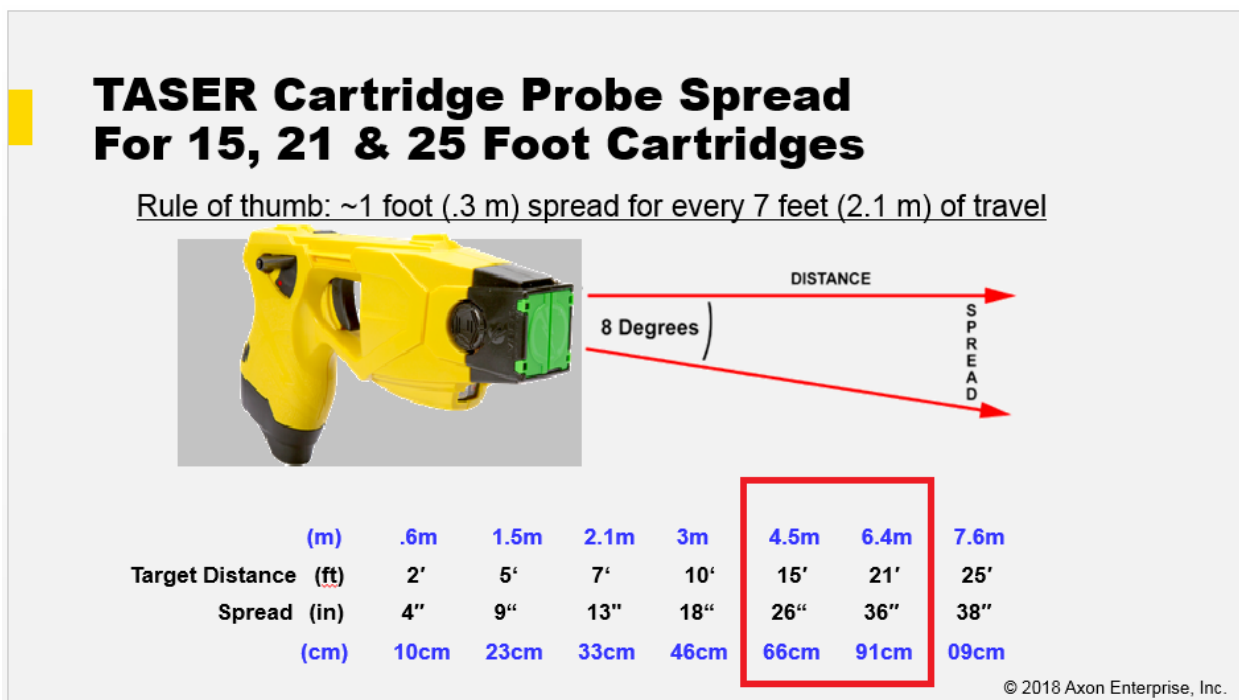

Once the probes are deployed and with a completed, or “closed” circuit, the Taser X26P delivers approximately 19 pulses of electricity per second, abbreviated as PPS. However, if the circuit is NOT completed, such as when one of the probes is not connected or misses the target, the Taser X26P will internally detect this “open” circuit and immediately reduce the charge to approximately 9 PPS. This is to not only save battery power but also designed by Axon to improve service life of the device.

Lastly, an alternate use for the X26P is a “drive stun”, where the barrel end or tip of the Taser is pushed directly onto a person, which alone will NOT cause NMI. This is designed only as a pain compliance technique. This is done by either first removing the cartridge or by “driving” the previously deployed cartridge against the target’s body and pulling the trigger. The metal diodes that are exposed by either removing the cartridge or after the probes are deployed, complete their

own circuit and deliver a charge that causes pain to the subject. **However, if the probes have been deployed, and at least one probe is still connected to the target subject, AND the corresponding wire is intact,** a drive stun can be used to complete the circuit, causing a “spread” between the single connected probe and the point of the drive stun. If this is done so with a sufficient spread between the two points, NMI can occur. For example, in the instance when a Taser is deployed and one of the probes misses the target, the circuit will remain “open” and thus the charge will not be delivered. The user can then engage the target subject by delivering a drive stun, thus closing the aforementioned open circuit between the single connected probe and the point of the drive stun, potentially delivering a charge to the target that could cause NMI. (Again, this tactic is NOT pertinent to the investigation at hand, but offered here to better clarify how the device works. A video example of this tactic produced by Axon Enterprise, Inc. was retained as a reference in this case, titled “Drive Stun Follow Up”.)

### Taser X26P – Event Logs and Pulse Graphs

## Event Log

Seq #	Local Time [dd:mm::yyyy Hr:min:Sec]	Event [Event Type]	Duration [Seconds]	Temp [Degrees Celsius]	Batt Remaining [%]
6	28 Jun 2013 14:31:03	Armed		27	83
7	28 Jun 2013 14:31:05	Trigger	8		83
8	28 Jun 2013 14:31:12	Safe	9	29	83

The Taser X26P is equipped with an internal flash memory that records any activation of the device. This “Event Log” includes the time stamp and/or duration of a deployment, as well as the event type. For instance, when an officer merely deactivates the thumb safety to check the battery life for the device at the start of their shift, this event is preserved. If the Taser is deployed by the press of the trigger, whether to deploy the probes or re-engage previously deployed probes, the event type is preserved in the memory as “Trigger” and the log includes the date and time of the event, the duration in seconds of the deployment, and the remaining battery life in the device at the time of that event. The contents of the internal memory of the Taser X26P is downloaded to a PC via a proprietary USB adapter and using software branded as *Evidence Sync* by Axon Enterprise Inc.

Once the Taser is attached to the USB cable and plugged into a PC, Evidence Sync will acquire the contents and prepare an “Event Log” that is retained as a PDF. The Event Log itself can be scaled down using a series of filters, such as acquiring only events in a given time period.

*As it relates to this incident and as previously noted in a supplemental report by Senior Inspector Bill Massey, it is important to note that each Taser X26P maintains its own internal clock and in cases such as this, it is common to see a variation in time between the actual time and date when an event occurred and that which is noted on the Event Log. The Taser X26P will only update its*

internal clock and complete a “time sync” AFTER data is downloaded to Evidence Sync. Prior to this event, the last time sync completed on Deputy Wang’s Taser was October 2<sup>nd</sup>, 2017.

Using Evidence Sync the user can also acquire a “Pulse Log” for an event triggered by a pull of the trigger. This log generates three dotted lines showing various measurements of the event itself, spreading horizontally across the graph and delineated vertically to represent time in seconds. The left vertical margin measures the voltage and the right horizontal margin measures the microcoulombs, which is a unit to represent a very small amount of electricity. (A coulomb is a charge equal to the amount of electricity conveyed in one second by a one amp current. A microcoulomb is 1/1,000,000 of a coulomb.)

### Pulse Log Graph

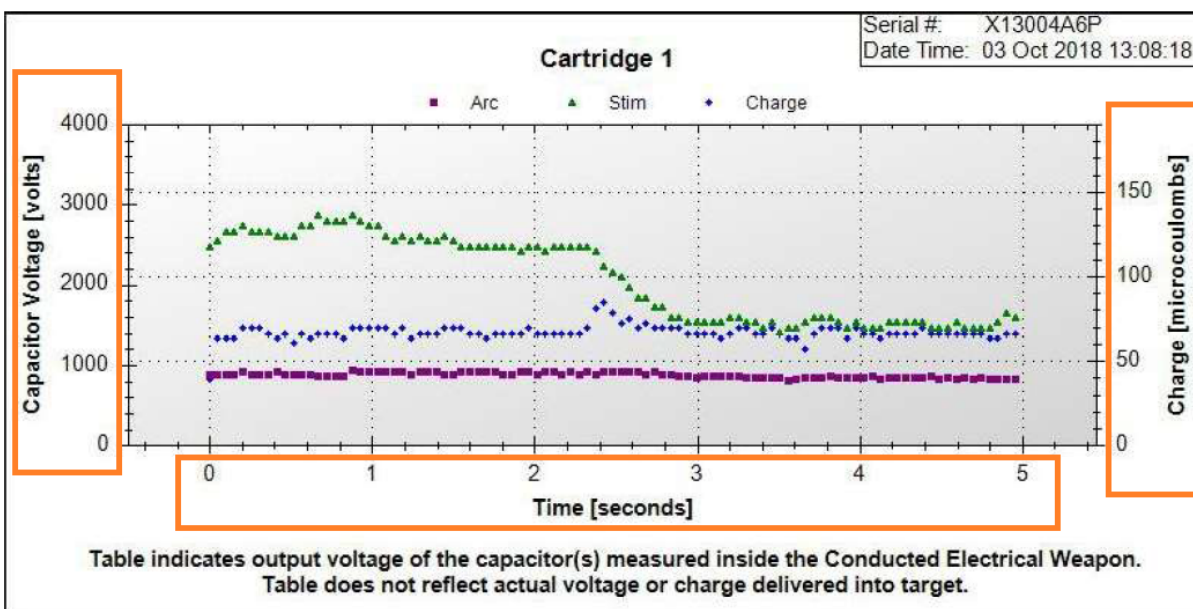

For our purposes, the purple line, or “Arc” has no investigative value, and merely represents that the device is functioning in a manner that could potentially create an arc between the probes. The blue dotted line, the “Charge” indicates whether or not the circuit was complete (both probes connected) AND if the circuit was sufficient to maintain the optimum charge of 63 microcoulombs, which Axon Enterprise Inc. has identified as the optimal charge to cause NMI to the target subject. If for instance the circuit is open or incomplete (such as one or more disconnected probes), the blue line will drop down near 0 volts and charge, representing the reduction in PPS as explained earlier in this report. The green dotted line, or “Stim” (Stimulation) represents the voltage, which reflects the ongoing effort of the Taser X26P to “push” the flow of power faster or slower (recalling the comparison to water pressure) in an effort to create an arc of the optimum 63 microcoulombs. In regards to the vertical time increments, note that the device measures and records each of these values approximately 20 times per second.



Lastly, as noted in the footnote for each graph, NONE of the reflected data indicates the actual voltage or charge delivered to the target subject. Thus, it offers NO indication that the deployment was effective, but rather only if the circuit was completed and the optimum charge was reached by the device. In layman terms, nothing in the graph reflects whether or not the target subject felt the effects of the Taser X26P.

For the purpose of this investigation, I used Evidence Sync and the necessary USB cable to analyze Deputy Wang’s Taser X26P, specifically the Event Log for the time period in question and the Pulse Logs for the individual activations. My analysis is as follows:

### EVENT LOG FOR OCTOBER 3<sup>rd</sup>, 2018

**Device (X26P)**

Seq #	Local Time [DD:MM:YYYY hh:mm:ss]	Event [Event Type]	Duration [Seconds]	Temp [Degrees Celsius]	Batt Remaining [%]
477	03 Oct 2018 13:08:18	Trigger	5		54
478	03 Oct 2018 13:08:32	Trigger	5		54
479	03 Oct 2018 13:08:46	Trigger	5		54
480	03 Oct 2018 13:09:19	Trigger	5		53
481	03 Oct 2018 13:09:31	Trigger	5		53
482	03 Oct 2018 13:09:41	Trigger	5		53
483	03 Oct 2018 13:09:52	Trigger	4		53

The above Event Log represents the seven (7) activations that occurred during this incident, whereby the trigger was pulled, causing the device to then attempt to close the circuit in each instance and deliver the necessary charge to possibly incapacitate the Decedent. As stated previously, all 7 occurrences lasted 5 seconds or less, as indicated in the “Duration” column. This in turn allowed me to generate a pulse graph for each occurrence.

**Activation #1 – October 3<sup>rd</sup>, 2018 at 13:08:18**

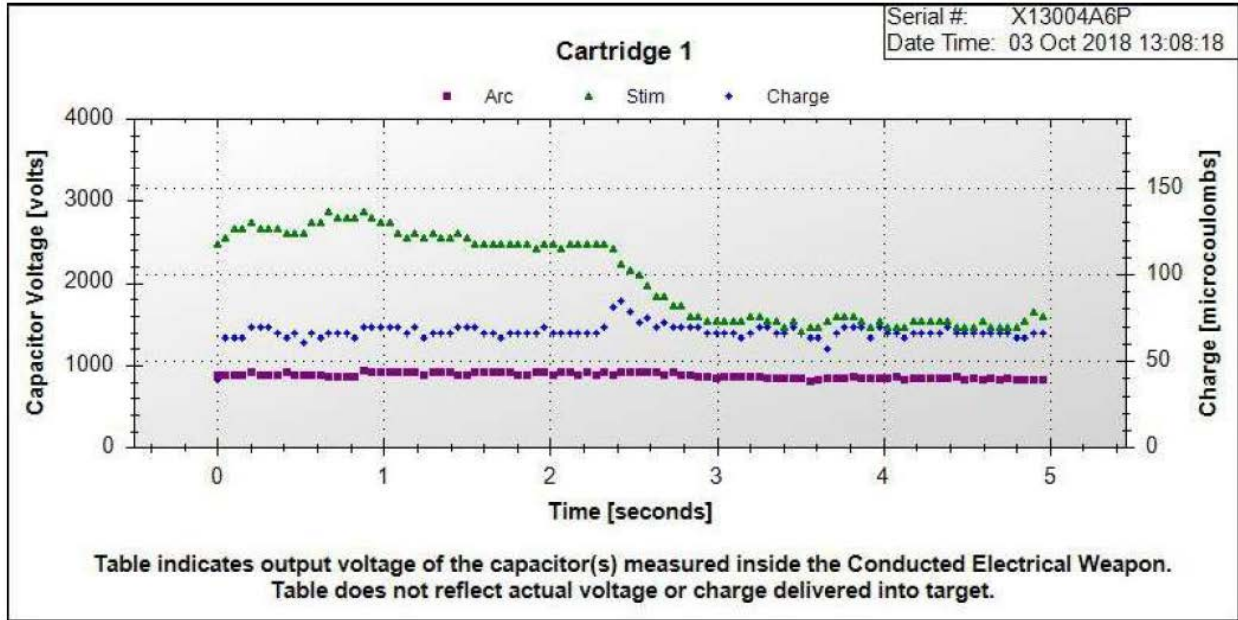

The pulse graph for activation #1 indicates a 5 second activation consisting of a completed circuit that delivered the necessary charge (approx. 63 microcoulombs) to potentially cause NMI, noting that at the 2.2 second mark the charge briefly spiked upwards, causing the device to reduce the voltage (green dots) in order to return the charge (blue dots) to the appropriate level. This graph reflects that the Taser is functioning in a closed circuit and in a manner that could debilitate the target subject.

**Activation #2 – October 3<sup>rd</sup>, 2018 at 13:08:32**

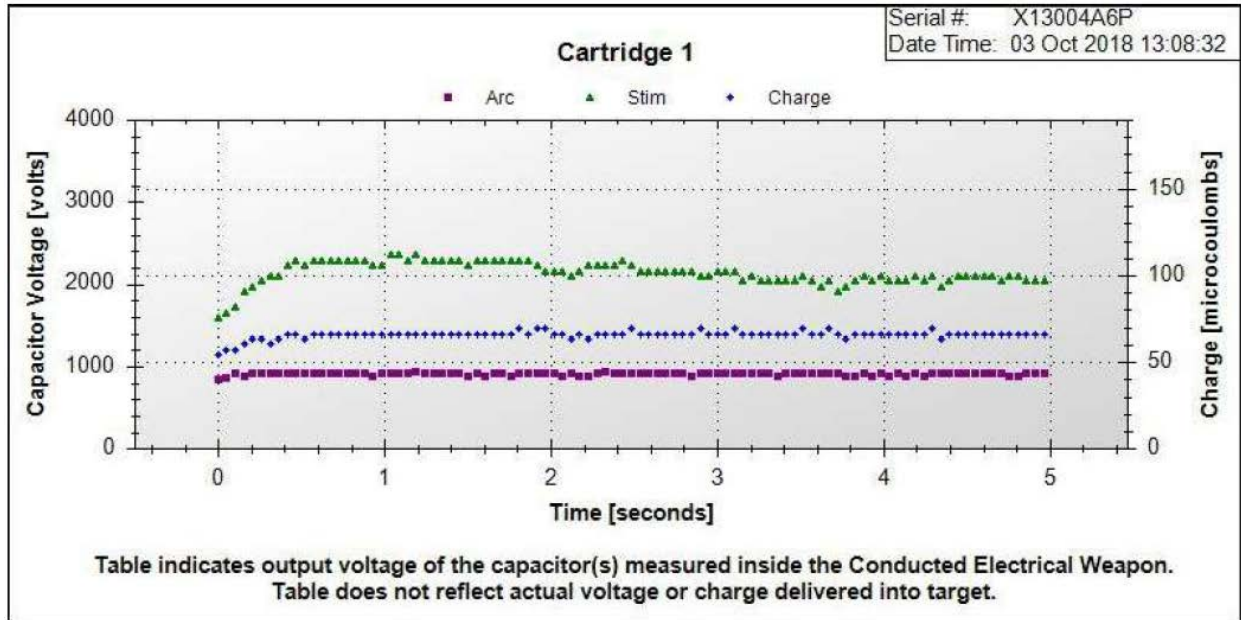

The pulse graph for activation #2 indicates a 5 second activation consisting of a completed circuit that delivered the necessary charge (approx. 63 microcoulombs) to potentially cause NMI, noting that at the initial deployment the device increased the voltage in order to reach the necessary charge and was able to maintain it for a 5 second pulse. This graph reflects that the Taser is functioning in a closed circuit and in a manner that could debilitate the target subject.

**Activation #3 – October 3<sup>rd</sup>, 2018 at 13:08:46**

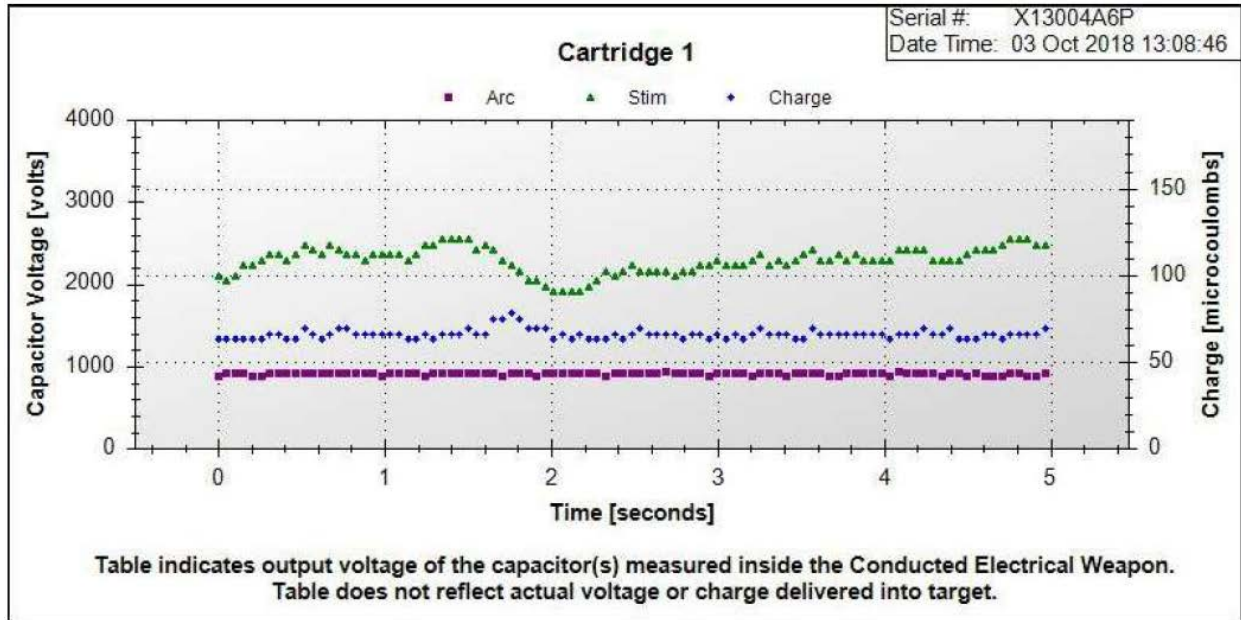

The pulse graph for activation #3 indicates a 5 second activation consisting of a completed circuit that delivered the necessary charge (approx. 63 microcoulombs) to potentially cause NMI, noting that at the initial deployment the device again briefly increased the voltage in order to reach the necessary charge and was able to maintain it for a 5 second pulse, noting that it decreased downward at the two second mark following a brief upward spike in the charge. This graph reflects that the Taser is functioning in a closed circuit and in a manner that could debilitate the target subject.

Activation #4 – October 3<sup>rd</sup>, 2018 at 13:09:19

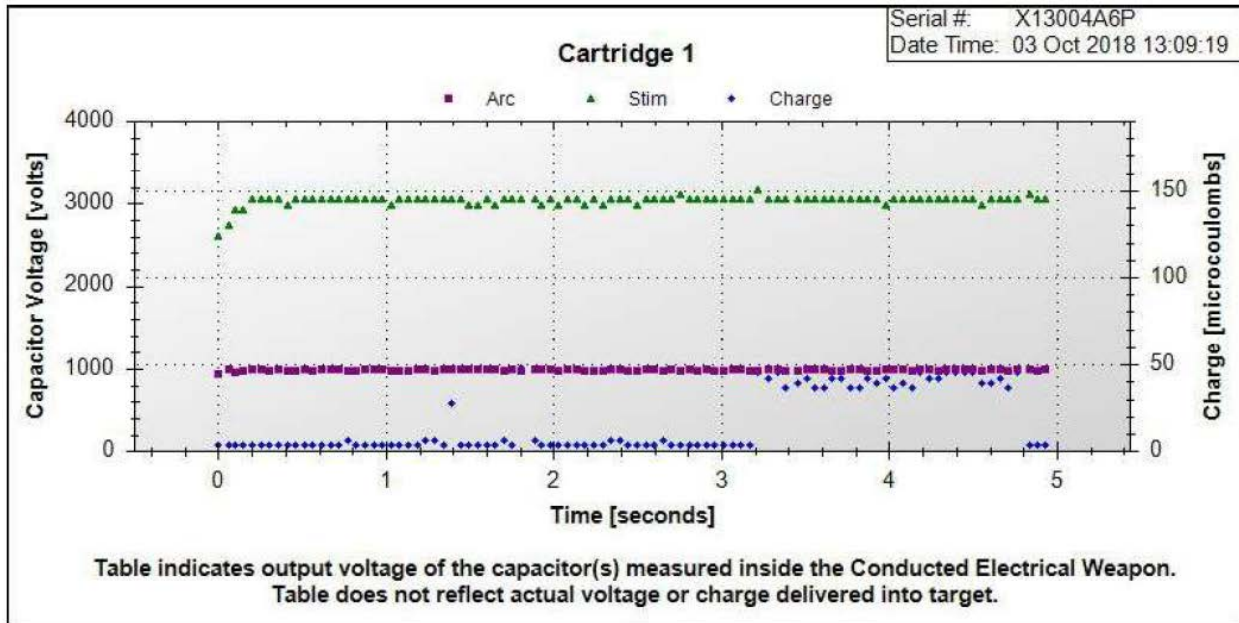

The pulse graph for activation #4 indicates a 5 second activation whereby the circuit is open and incomplete for the first 3 seconds, causing the device to immediately reduce the charge to near zero (0) as the voltage spiked and remained at 3000 volts in an effort to complete the circuit (create an arc between the probes). This was possibly due to a disconnected probe or wire. At the 3.1 second mark, the charge spikes to just below 50 microcoulombs and remains sporadic as the volts remain maximized, with the device still struggling to complete the circuit. This graph represents an unsuccessful and ineffective deployment of the Taser where the device struggled to close the circuit, including the final 1.3 seconds when the charge remained well below 50 microcoulombs and thus never sufficient to cause NMI.

On 11-9-18, following my own analysis, I presented this pulse graph to Bryan Chiles, Product Compliance Manager for *Axon Enterprise Inc.* and a previously recognized expert witness in the Taser pulse graphs. I asked him, “Looking at just the graph, it’s not likely that this activation had any effect on him?” He replied, “Guaranteed no effect for the first 3 seconds...but he or someone else may have laid on the wire and briefly felt something from it (in the final 2 seconds)...but definitely not NMI. I don’t know if it arced on him (the Decedent’s person).” *In conjunction with the available video of the event, the Decedent may have briefly turned into the wire with this arm and felt some noticeable effect from the charge.*

Activation #5 – October 3<sup>rd</sup>, 2018 at 13:09:31

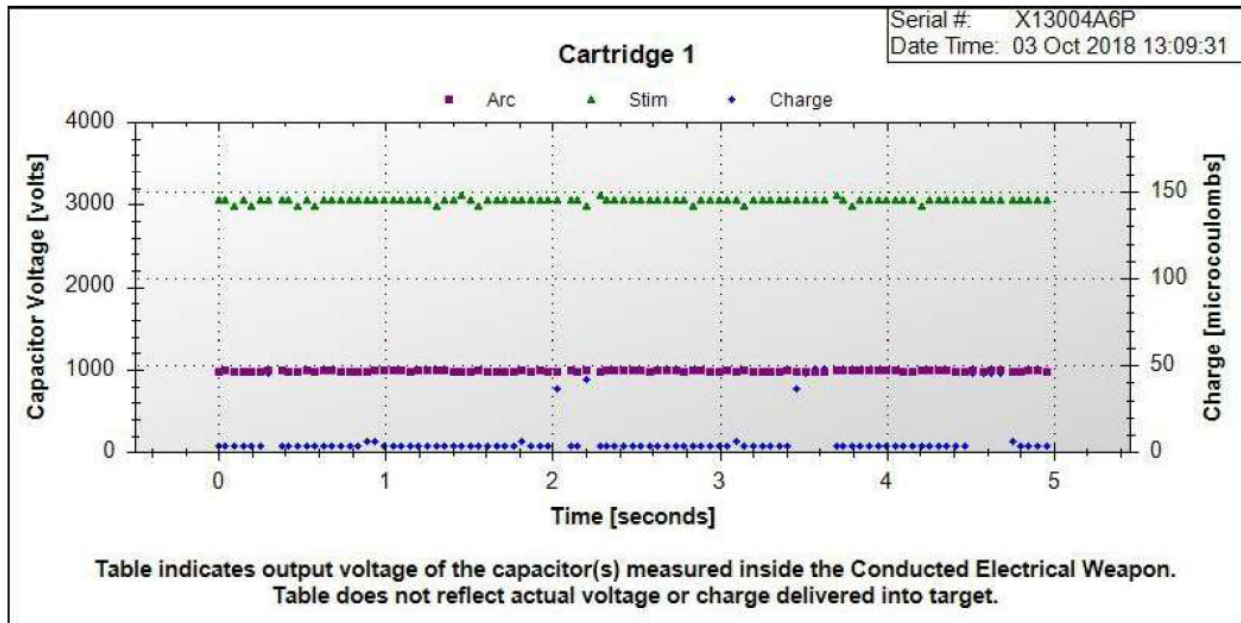

The pulse graph for activation #5 indicates a 5 second activation whereby the circuit remains open and incomplete for the entire deployment and thus NOT functioning in a manner that would cause any incapacitation whatsoever to the target subject, possibly from a disconnected probe or wire. This graph represents an unsuccessful and ineffective deployment of the Taser where the device never functioned with a closed circuit and was unable to deliver any charge to the target subject.



Activation #6 – October 3<sup>rd</sup>, 2018 at 13:09:52

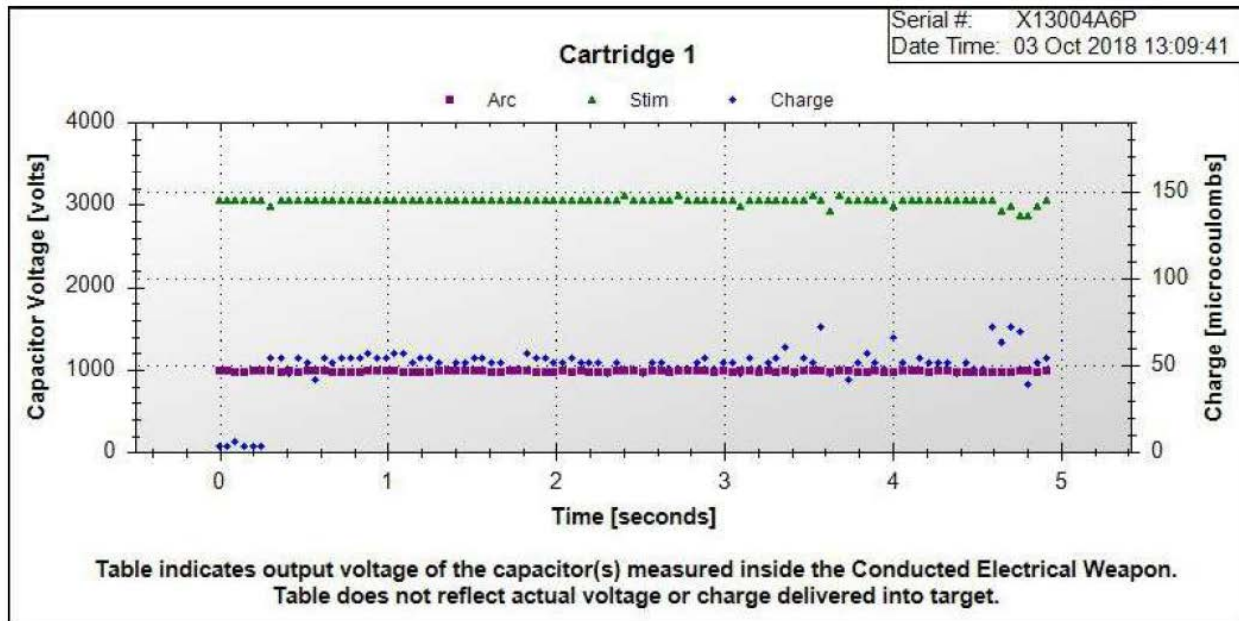

The pulse graph for activation #6 indicates a 5 second activation whereby the circuit was closed, but the charge was sporadic throughout the deployment as the voltage remained maximized in an effort to create a consistent arcing circuit. The charge itself also with rare exception remained well below the 63 microcoulombs threshold necessary to cause NMI and/or have any physical effect on the target subject.

During my initial analysis of activation #6, it was my opinion that the charge was likely arcing at the barrel end of the Taser (similar to a drive stun), rather than between the probes, possibly due to one or more broken wires and thus having no physical effect on the Decedent. On 11-9-18, I presented this pulse graph to Brian Chiles. He added, “The weapon is arcing and you can probably hear it (*which is consistent with the available video*),” but it was his opinion that the charge was more likely arcing between crossed wires. He also agreed that regardless of which of the above scenarios led to the above data, this graph still represents an unsuccessful and ineffective deployment of the Taser where the charge is clearly, “not arcing to a person.” He expanded on this, saying, “When the device is arching in error, (the charge) is variable,” and appears sporadic as it does in this graph.



Activation #7 – October 3<sup>rd</sup>, 2018 at 13:09:41

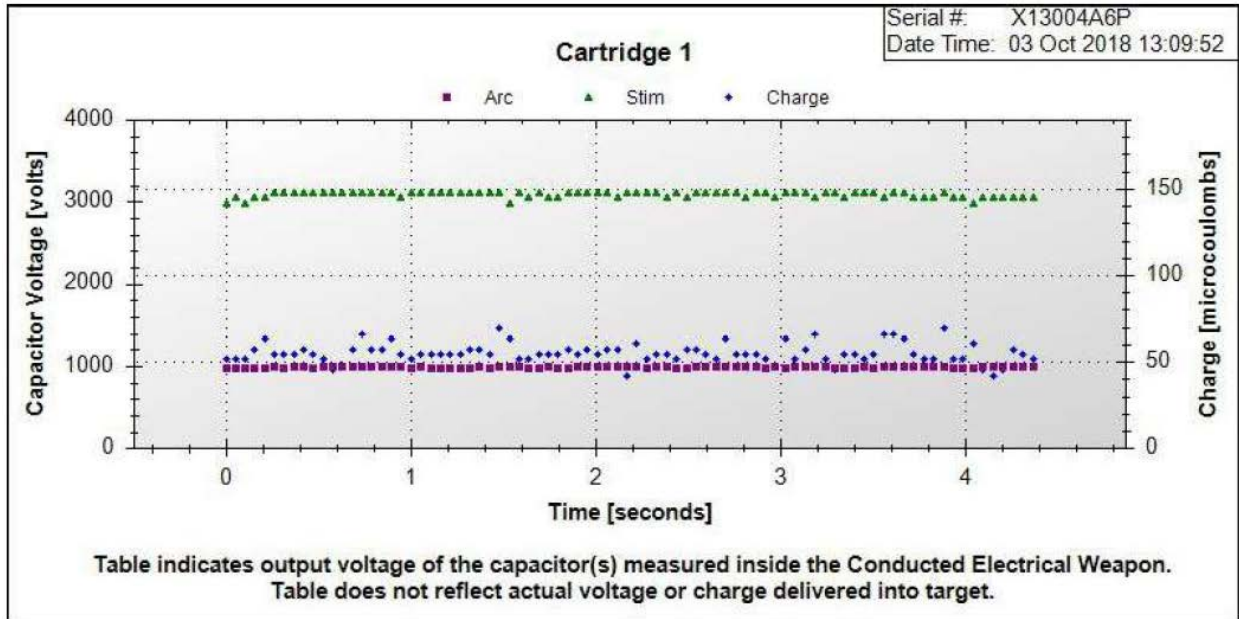

The pulse graph for activation #7 is similar to that of #6, indicating a 5 second activation whereby the circuit was closed, but the charge remained sporadic throughout the deployment as the voltage remained maximized in an effort to create a consistent arcing circuit. The charge again with rare exception remained well below the 63 microcoulombs threshold necessary to cause NMI and/or have any physical effect on the target subject. On 11-9-18, when presented with this graph, Chiles again agreed with my assessment that the pulse graph for activation #7 represents an unsuccessful and ineffective deployment of the Taser where the charge is not arcing properly, either due to broken or crossed wires.

## CONTROLLED TEST ACTIVATION – November 8<sup>th</sup>, 2018 at 13:16:39

Lastly, and upon completion of my above analysis, I personally activated Wang's Taser X26P for a period of two seconds on 11-8-18, with both wires completely detached and the expelled cartridge still engaged on the device. I was able to replicate the results explained above for activations #6 and 7, validating the analysis of the activations in question. The chart is presented here for comparison:

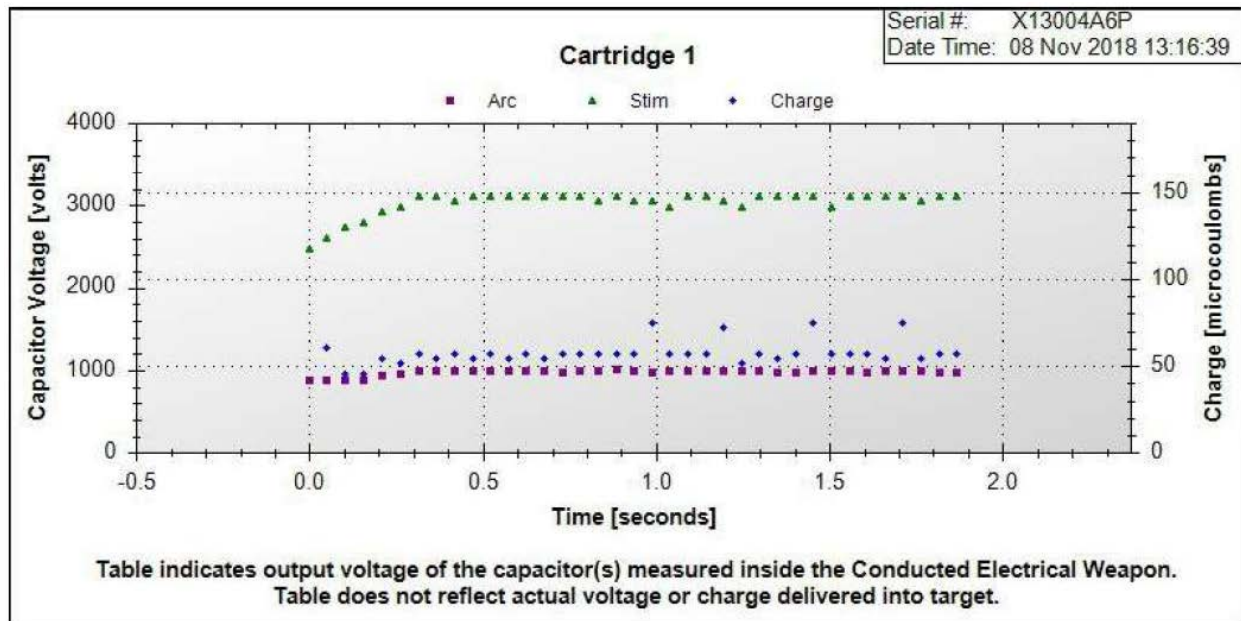

## Conclusion

Based on my training and experience in both the personal use and deployment of a Taser CEW, my own discussions with various persons including Brian Chiles of Taser Enterprise Inc. who are familiar with the operation of the Taser X26P, and on my own analysis of the Event Log and Pulse Logs retained by Deputy Wang's Taser X26P for this incident, it appears the circuit was closed and operating efficiently during activations #1, #2, and #3, delivering a charge via a closed circuit at a level and in a manner that could have had a physical effect on the Decedent and/or caused some level of NMI. With the exception of the final 1.8 seconds of activation #4, it is also my opinion that deployment #4, 5, 6, and 7 had no physical effect (no NMI) on the Decedent for the reasons described above for each individual activation based on the related pulse graph data.



**SAN MATEO COUNTY DISTRICT ATTORNEY'S OFFICE**

400 COUNTY CENTER, 3RD FLOOR REDWOOD CITY, CA 94063 650-363-4636

SUPPLEMENT 30 - Supervision of Crime Scene

18-1003-02

**SUMMARY:**

On October 3, 2018, at 2:20 PM, I responded to El Camino Real and Millwood to assist in an officer involved incident involving deputies from the San Mateo County Sheriff's Office and Chinedu Okobi. I arrived at scene at approximately 2:50 PM, reported to the command post, and was assigned to the crime scene. I remained at the crime scene until all available evidence was collected and the roadway reopened.

**INVESTIGATION:**

On October 3, 2018, at 2:20 PM, I responded to El Camino Real and Millwood to assist in an officer involved incident involving deputies from the San Mateo County Sheriff's Office and Chinedu Okobi. Prior to my arrival Okobi and Deputy Joshua Wang were transported to Mills-Peninsula Hospital for additional treatment and care. Deputy Wang was released from the hospital after receiving treatment for his injuries. Life-saving measures were taken to revive Okobi, but he was pronounced deceased at the hospital. I arrived at scene at approximately 2:50 PM, reported to the command post, and was assigned to the crime scene by Sr. Inspector Bill Massey. San Mateo County Sheriff's Sgt. Trickett was the Incident Commander at the scene. He identified the involved parties and debriefed the incident. Sgt. Trickett also walked us through the crime scene.

**Involved Parties:**

- Sergeant David Weidner
- Deputy Joshua Wang
- Deputy Alyssa Lorenzatti
- Deputy John Demartini
- Deputy Bryan Watt
- Community Service Officer (CSO) Joseph Gonzales

**Decedent:**

The decedent was verbally identified as Chinedu Okobi: DOB 2/13/82; CA DL #D1633334; described as black male, 6 feet 3 inches tall and 337 pounds; a possible address of 127 Eastridge Cir. in Pacifica was provided, but was unverified at the time.

**Crime Scene Summary:**

The purpose of this summary is to provide a general overview of the crime scene. It is not intended to be an exact accounting of the evidence. Criminalists Cindy Anzalone and Anthony Delmonico from the San Mateo County Crime Lab processed the scene and collected evidence. See their reports for specific information on the evidence collected and where it was located.

This incident occurred on El Camino Real in the City of Millbrae. In this area, El Camino Real is a flat paved asphalt road traveling north and south with three lanes of travel in each direction. The posted speed limit is 35 MPH. Traffic was heavy, but typical for this roadway. The roadway was dry and the weather clear. There are no traffic signals or stop signs controlling traffic on El Camino Real where the majority of the incident occurred. There are stop signs controlling the traffic on the adjacent side streets.

**CONTROLLED DOCUMENT**

Prepared By: 80215 GIGUIERE, GREGORY	Date: 11/14/2018	Approved By: 80240 WARREN, JOHN	Date: 12/17/2018
---	---------------------	------------------------------------	---------------------



The incident initiated south of the intersection of Capuchino Dr. However, the main body of evidence is located on El Camino Real between Capuchino Dr. and Santa Helena Ave.

Upon my arrival, El Camino Real was closed to through traffic from Millwood Dr. to Park Blvd. The scene was secured with crime scene tape, cones, signs, patrol vehicles, and patrol personnel.

At 10:04 PM Sergeant Weidner, Deputy Lorenzatti, and Deputy Watt were escorted to their respective patrol vehicles and allowed to remove personal items from the scene.

All of the patrol vehicles were removed from the crime scene by the Sheriff's department, the crime scene broken down, and the roadway reopened at approximately 11:08 PM.

**Vehicles:**

Vehicle #8 was driven by Deputy Alyssa Lorenzatti. This vehicle was located in the #1 lane on south bound El Camino Real. It was facing south and near the intersection of Capuchino Dr.

Vehicle #37 was driven by Deputy Bryan West. This vehicle was located in the #3 lane on south bound El Camino Real. It was facing north and was south of Santa Helena Ave.

Vehicle #1 was driven by Sergeant Weidner. This vehicle was also located in the #3 lane on south bound El Camino Real. It was facing north, south of Santa Helena Ave, and east of Vehicle #37.

Vehicle #10 was driven by Deputy Wang. This vehicle was located in the #3 lane of north bound El Camino Real. It was facing south in the roadway north of Santa Helena Ave.

Vehicle #115 is a utility truck and was driven by CSO Joseph Gonzales. This vehicle was located in the # 2 lane on north bound El Camino Real. It was facing north and west of Vehicle #10.

Vehicle #16 was driven by Deputy Demartini. It was moved from the scene prior to my arrival and parked at the Millbrae substation located at 581 Magnolia Ave.

All of the vehicles were marked and clearly identifiable as Police vehicles. The red and blue lights had been activated during this incident.

The patrol vehicles are equipped with MVAR's.

I visually inspected each vehicle. They did not appear to be damaged. I also looked inside each vehicle and did not find anything out of the ordinary.

**Evidence:**

See the crime lab reports for specific evidence collected at scene. Criminalists Anzalone and Delmonico photographed, measured, and diagrammed the scene with the assistance of a 3D scanner. Some of the evidence they collected at the scene included:

- Personal items that appear to belong to Okobi.
- Taser (CEW), cartridge, wires, miscellaneous parts.
- White Towel
- ASP retractable baton.
- OPA: Oralpharyngeal Airway used by EMS at scene.
- Photographs of Deputy Wang's duty belt and weapon were taken at scene. There were no reports or evidence that a firearm was used during this incident, but each magazine was inspected and counted. There were 17 bullets in each magazine. One bullet was removed from the chamber.

**CONTROLLED DOCUMENT**

<b>Prepared By:</b> 80215 GIGUIERE, GREGORY	<b>Date:</b> 11/14/2018	<b>Approved By:</b> 80240 WARREN, JOHN	<b>Date:</b> 12/17/2018
--	----------------------------	---	----------------------------





- Photographs of CSO Gonzales along with swabs of his uniform.
- The photographs of the Deputies and the collection of their equipment did not occur at the crime scene.

**Tri Counties Bank:**

Some of the evidence listed above was located at scene in front of Tri Counties Bank located at 1551 El Camino Real. There is an ATM located near the northeast corner of the building with an internal camera that might have captured part of this incident. I went inside Tri Counties Bank and met Hilda Delgado who is the Vice President - Branch Manager. Delgado was not at the bank during this incident. I asked Delgado if she could assist me with the retrieval of the video from the ATM. She contacted Bob Collins from security and he asked to speak with me directly. Collins told me he would be unable to assist me at this time and referred me to Richard Ellena. I called Ellena who told me he would retrieve the recording and send it to me via e-mail.

On October 4, 2018, I received an email from Ellena with ten (10) separate recordings from the ATM. Ellena advised that a VLC Media player would be needed in order to play back the recordings. I provided a copy of the recordings to the primary investigators assigned to this case for review. There was a report a customer being present at the ATM during this incident. I asked Ellena if he could verify this information and provide me with the identity of the customer. He told me he could provide me with the identity of the customer, but he would need a court order to release the customer's information.

**DISPOSITION:**

Attach to Original Report

**CONTROLLED DOCUMENT**

Prepared By: 80215 GIGUIERE, GREGORY	Date: 11/14/2018	Approved By: 80240 WARREN, JOHN	Date: 12/17/2018
---	---------------------	------------------------------------	---------------------



**Investigation:**

On October 4, 2018, at 11:30 AM, I responded to San Mateo General Hospital located at 222 W 39<sup>th</sup> St in San Mateo for the autopsy of Chinedu Okobi. Dr. Thomas Rogers performed the autopsy and Criminalist Michael Fish was present from the crime lab. Dr. Rogers told me that Okobi appeared to have had cardiovascular disease and an enlarged heart. He had abrasions on his right hand and left elbow, but did not appear to have any other external or internal injuries consistent with trauma. Dr. Rogers explained that his wrists had internal bruising that is typical with someone who has been handcuffed. Okobi's trachea, neck, and airway did not show any of the typical signs of injury that can be seen when a carotid restraint is applied. However, Okobi did exhibit signs of petechiae in his eyes. Dr. Rogers located one taser probe in Okobi's right upper torso and a minor injury that could have been caused by the impact of another probe on his right arm. Dr. Rogers advised that the toxicology results will be included in his final report. See his report for further details.

I collected 19 items of evidence including bedding from Mills-Peninsula Hospital, personal clothing, a taser probe, and biological evidence from Okobi. I individually packaged and sealed each item and secured the evidence at the District Attorney's office.

On October 5, 2018, I booked the items from the autopsy into evidence at the San Mateo County Sheriff's property unit. See the attached property report for a complete list.

**Coroner's Office:**

On October 4<sup>th</sup>, 2018, I met Coroner Investigator Heather Diaz at the Coroner's Office and provided her with an update. After our conversation she released Okobi's cellular phone and a USB drive to me. I secured each item in an evidence envelope (for safekeeping) and transported these items to the District Attorney's office to be booked into property.

**Personal Property**

On October 3, 2018, Inspector Draper retrieved Okobi's personal items from the Millbrae substation. These items were contained in two bags. On October 5, 2018, I inventoried the bags and booked them into the Sheriff's Office property unit for safekeeping. I did not find anything of monetary value or medications while conducting the inventory. I did find a copy of a Discharge Transition Plan from Community Bridges, Inc. (CBI). Okobi is listed as the client. It is dated September 26, 2018. I conducted a google search of CBI. I found website at <https://communitybridgesaz.org/> that matches the paperwork I found. According to the website CBI is a non-profit organization that provides medically integrated behavioral health programs.

I found two other items of interest. Okobi had a Community Information Handbook from the San Mateo County Human Services Agency listing available resources. He also had a request for verification from HSA with a listed address of 271 92<sup>nd</sup> St., Daly City, CA 94015. The associated case number listed is 2008230.

**Disposition:**

**CONTROLLED DOCUMENT**

<b>Prepared By:</b> 80215 GIGUIERE, GREGORY	<b>Date:</b> 11/14/2018	<b>Approved By:</b> 80240 WARREN, JOHN	<b>Date:</b> 12/18/2018
--	----------------------------	---	----------------------------



**SAN MATEO COUNTY DISTRICT ATTORNEY'S OFFICE**

400 COUNTY CENTER, 3RD FLOOR REDWOOD CITY, CA 94063 650-363-4636

SUPPLEMENT 31 - Autopsy of Chinedu Okobi

18-1003-02

Attach to Original Report

**CONTROLLED DOCUMENT**

Prepared By:

80215 GIGUIERE, GREGORY

Date:

11/14/2018

Approved By:

80240 WARREN, JOHN

Date:

12/18/2018





**Summary:**

On October 3, 2018, at 2:20 PM, I responded to El Camino Real and Millwood Dr. to assist in an officer involved incident involving deputies from the San Mateo County Sherriff's Office and Chinedu Okobi. I arrived at scene at approximately 2:50 PM, reported to the command post, and was assigned to the crime scene. I remained at the crime scene until all available evidence was collected and the roadway reopened. During that time I met with Mark Gilbert who did not see any of the events leading to Okobi's arrest. He did provide the following paraphrased statement based upon what he saw after Okobi was handcuffed. This conversation was recorded with his knowledge.

**Statement of Witness Mark Gilbert:**

Mark Gilbert is the store manager at Kelly-More Paints located at 1497 El Camino Real. Gilbert said he saw bits and pieces of what occurred. Gilbert was working at the main counter, inside the store, which is located approximately 20 feet west from the front door and in the center of the store. He was helping customers at the counter when he heard noises that sounded like a vehicle accident had occurred outside on El Camino Real. He noticed traffic was starting to back up and he heard sirens. The store front has glass windows and a glass door, but he could not see what was going on. He remained inside the store and walked towards the northeast corner of the store to get a better look at what was going on. He was standing approximately 8 feet north of the front door and looked outside through one of the front windows. Things were getting chaotic and he thought he saw a total of 6 police vehicles. All the cars came to a stop and things got quiet. He could not hear anything, but saw a large subject sitting on the ground with his hands behind his back and several officers surrounding him.

Gilbert said the subject was sitting on the ground and in the north bound lanes on El Camino Real. Gilbert said he was sitting near the white towel in the roadway which appeared to be near the #2 lane. He told me his legs were positioned straight out in front of him. He was slouched forward, his mouth open, and he appeared to be out of breath. He wasn't moving much and didn't appear to be saying anything at this point. His hands were behind his back as if he was handcuffed but Gilbert did not see the subject get handcuffed. The officers touched him several times as if they were checking to see if he was ok.

There were approximately 4 uniformed officers around the subject and a couple more in the area. He would not be able to identify the officers, but thought one officer might have been Hispanic and the others White. The officers moved the subject out of the roadway and towards the sidewalk. Gilbert thought the subject was trying to sit up at one point and thought he was having difficulty breathing. There was one officer standing on his right, one on his left, and one directly behind him. The officers placed their hands on him to keep him sitting on the ground. Gilbert told me he never saw the subject stand up or get off the ground.

At that point Gilbert walked back to the counter to assist customers. On occasion he would leave the front counter to check on the activities outside. He walked back and forth several times checking on the activities outside. EMS personnel eventually took the subject from the scene.

**CONTROLLED DOCUMENT**

<b>Prepared By:</b> 80215 GIGUIERE, GREGORY	<b>Date:</b> 11/14/2018	<b>Approved By:</b> 80240 WARREN, JOHN	<b>Date:</b> 12/18/2018
--	----------------------------	---	----------------------------



I asked Gilbert if there were any customers or employees who saw any part of the incident. He said he did not know, but would check and get back to me.

**Additional Information:**

On October 12, 2018, I contacted Gilbert to obtain more information regarding the description of the subject he saw on the ground and the subject's actions while on the ground. Gilbert described then man on the ground as a heavy set African-American male approximately 30-35 years old. Gilbert also confirmed the subject was wearing a blue shirt and tan or khaki pants. Gilbert also added that he did not know who the man was and has no personal relationship with him.

Gilbert also confirmed the position of the officers as noted in his original statement. He told me the subject was not moving around very much. He said the subject was heavy and he thought he was sitting forward in a way that would have made it difficult for him to breathe. I tried to clarify how far forward he was sitting. He described it as sitting 3/4 of the way up.

He said the man was slouched forward slightly and did not appear very alert. He did not seem to respond much when the officers checked on him to see if he was alright. He almost seemed to be in an unconscious state. Gilbert said he was trying to look at his eyes and see his expression, but he couldn't see his face or eyes very well. His said the man's expression seemed blank. In summary, he confirmed that the subject was slumped over and not moving much while he was looking at him from his vantage point inside the store.

**DISPOSITION:**

Attach to Original Report

**CONTROLLED DOCUMENT**

Prepared By:  
80215 GIGUIERE, GREGORY

Date:  
11/14/2018

Approved By:  
80240 WARREN, JOHN

Date:  
12/18/2018



**Investigation:**

During my interview with Sergeant David Weidner on October 4, 2018, Sergeant Weidner discussed his prior awareness of the portion of El Camino Real where this incident occurred and the fact that he recognized it as being a “high traffic area”. Sergeant Weidner also talked about his knowledge of the City of Millbrae having a high occurrence of traffic accidents in which pedestrians have been struck by vehicles. Based upon this information, I researched San Mateo County Sheriff’s Office press releases available on the website related to traffic enforcement and significant traffic-related investigations involving pedestrians.

I found three (3) press releases related to injury “hit and run” accidents involving vehicles and pedestrians on El Camino Real in Millbrae. The first of these incidents was a fatal hit and run accident involving a pedestrian which occurred on January 12, 2014 at the intersection of El Camino Real and Millwood Drive. This is the same intersection Deputy Joshua Wang observed Decedent Chinedu Okobi crossing east against a red light on October 3, 2018. The second incident occurred on March 29, 2016 and was a hit and run accident with injuries sustained by a pedestrian which occurred in the 500 block of El Camino Real, approximately nine (9) blocks south of the intersection of El Camino Real and Millwood Drive. The third incident occurred on April 13, 2018 and was a hit and run accident with injuries sustained by a pedestrian which occurred in the area of El Camino Real and Silva Avenue, also approximately nine (9) blocks south of the intersection of El Camino Real and Millwood Drive. There did not appear to be any press releases issued by the San Mateo County Sheriff’s Office for pedestrian related traffic accidents when either no injury occurred or there was no subsequent criminal investigation stemming from the incident.

I also located six (6) press releases by either the San Mateo County Sheriff’s Office or the City of Millbrae regarding on-going traffic enforcement details related to pedestrian safety in the City of Millbrae. The first press release was dated December 3, 2012 and covered the implementation of a “pedestrian crosswalk safety program” along El Camino Real which was to continue until December 21, 2012. The press release stated the goal of the Sheriff’s Office Millbrae Patrol Bureau during this program was to raise awareness of both motorists and pedestrians. The increase in awareness was to be done via a series of strategies including in part the issuance of verbal warnings to motorists and pedestrians and the issuances of citations when appropriate. The release also discussed how the Millbrae Patrol Bureau would be working closely with the City of Millbrae’s Traffic Engineering Department and with Caltrans to “monitor and ensure pedestrian and motorist safety along the El Camino Real corridor” in Millbrae.

The second press release was dated January 17, 2018 and was issued by the City of Millbrae. This release covered activity by the San Mateo County Saturation Traffic Enforcement Program (STEP) set to occur that date in the cities of Millbrae and Burlingame. The release noted this was the first of a series of planned multi-agencies saturation deployments scheduled for 2018. The release noted the San Mateo County Police Chiefs and Sheriff Association was working collectively to focus on reducing the number of injuries and traffic accidents throughout San Mateo County. The release also included safety tips for

**CONTROLLED DOCUMENT**

Prepared By: 80205 DRAPER, JAMIE	Date: 11/27/2018	Approved By: 80240 WARREN, JOHN	Date: 12/17/2018
-------------------------------------	---------------------	------------------------------------	---------------------





both drivers and pedestrians. Among the safety tips for pedestrians was “Be predictable. Follow the rules of the road, cross at crosswalks or intersections, and obey signs and signals.”

The third press release was dated May 18, 2018 and documented a traffic enforcement operation set to occur the same date. The stated goal of the enforcement detail was “focused enforcement on collision causing factors involving motorists and pedestrians” which would be achieved via routine traffic patrols focused on “trouble spots” on the El Camino Real corridor in Millbrae. The release additionally included a passage which stated: “Deputies will be looking for traffic offenses made by drivers and pedestrians alike that can lead to life changing injuries”. The release also stated “enforcement will be taken for observed violations when pedestrians cross the street illegally or fail to yield to drivers who have the right of way. Pedestrians should cross the street only in marked crosswalks or at corners”. The forth press release was an after-operation summary for the May 18, 2018 deployment which was authored by Sergeant David Weidner. During my research, I found that the May 18, 2018 enforcement operation was featured on KRON 4 as part of their “People Behaving Badly” segment and was available for view on their website. Reporter Stanley Roberts rode along with Sergeant Weidner during the deployment and filmed the activities of the deputies. Among the enforcement stops featured during the segment was a pedestrian being stopped and cited for crossing against a red traffic signal in the 600 block of El Camino Real, approximately eight (8) blocks from the intersection of El Camino Real and Millwood Drive.

The final two (2) press releases were related to a special traffic enforcement detail scheduled for September 28, 2018. The first of these releases, dated September 21, 2018, documented the plan to conduct traffic safety enforcement in the cities of Millbrae and San Carlos. This memo included safety tips for drivers and pedestrians similar to those listed in the January 17, 2018 press release issued by the City of Millbrae. A safety tip listed for pedestrians included, “Follow the rules of the road, use crosswalks or intersections, and obey signs and signals”. The second related release was dated October 1, 2018 and was the after-operation summary for the September 28, 2018 enforcement detail. This release was issued two (2) days prior to the incident with Decedent Chinedu Okobi on October 3, 2018.

On November 26, 2018 I spoke via telephone with Captain Paul Kunkel of the San Mateo County Sheriff’s Office regarding traffic related issues within the City of Millbrae. Captain Kunkel is currently the Commander for the Millbrae Patrol Bureau and was assigned to his current assignment on September 11, 2018. Captain Kunkel told me there have “been a number” of injury accidents involving pedestrians along the El Camino Real corridor in Millbrae that he is aware of since the San Mateo County Sheriff’s Office assumed police services for the city. Captain Kunkel said the Sheriff’s Office has worked very hard to mitigate the factors which have led to these accidents including working to educate the public, utilizing stricter enforcement and working with City of Millbrae and Caltrans engineers to increase pedestrian safety. Captain Kunkel told me from his previous employment as a police officer with the City of Menlo Park, he knows the number one complaint from citizens to city officials are traffic related complaints and traffic safety issues. Captain Kunkel said his experience with the City of Millbrae thus far is consistent with this as well. Captain Kunkel said traffic speed and safety on the El Camino Real

**CONTROLLED DOCUMENT**

<b>Prepared By:</b> 80205 DRAPER, JAMIE	<b>Date:</b> 11/27/2018	<b>Approved By:</b> 80240 WARREN, JOHN	<b>Date:</b> 12/17/2018
--	----------------------------	---	----------------------------



**CONTROLLED DOCUMENT**

on the El Camino Real corridor in Millbrae have been among the biggest complaints the Millbrae Patrol Bureau has received. Captain Kunkel told me the portion of El Camino Real near Millwood Drive, where the roadway has six (6) lanes of traffic, is among the widest points of El Camino Real as it extends throughout the peninsula which may help contribute to increased traffic and traffic accidents based upon the volume of vehicles passing through this area. Because of this, Captain Kunkel said he has made traffic enforcement and pedestrian safety in Millbrae a point of emphasis with the Sergeants and Deputies working under his command. Captain Kunkel cited the multiple special traffic enforcement details and his expectation that the Deputies under his command conduct increased traffic enforcement as some of the efforts being made to improve traffic safety in Millbrae. Captain Kunkel also noted Caltrans and the City Engineers have worked to improve the safety of many crosswalks on El Camino Real by adding High Intensity Activated Crosswalks (HAWKs) pedestrian crossing beacons because of the high number of pedestrian related accidents.

On November 26, 2018 I spoke with Sergeant Jason Peardon with the San Mateo County Sheriff's Office. Sergeant Peardon is currently one (1) of the supervisors for the Sheriff's Office Major Accident Investigations Team (MAIT). Sergeant Peardon told me the El Camino Real corridor in Millbrae is the most active stretch of roadway in Sheriff's Office jurisdiction for pedestrian related traffic accidents. Sergeant Peardon said he was aware of at least eight (8) fatal or major injury accidents involving pedestrians which his team has responded to on El Camino Real in Millbrae since the San Mateo County Sheriff's Office began contracting police services for the City of Millbrae in 2012. Sergeant Peardon said there are likely many more non-fatal accidents or accidents with less serious injuries involving pedestrians in the same area during the time frame, but his team would not have responded to those incidents. Sergeant Peardon provided me the locations for each of these eight (8) accidents and I noted all eight (8) appeared to have been within approximately ten (10) blocks or less from the intersection of El Camino Real and Millwood Drive. Two (2) of these incidents occurred at or near the intersection of El Camino Real and Millwood Drive.

In reviewing information regarding the City of Millbrae, I noted the population for the city is currently listed as approximately 22,500 residents. I also noted the El Camino Real corridor through the City of Millbrae is approximately 1.5 miles in length. On November 27, 2018 Sergeant Jon Sebring provided me a list of all pedestrian related traffic accidents which had been reported to have occurred in the 1.5 mile stretch of El Camino Real through the City of Millbrae since 2012. This list contained forty-eight (48) pedestrian related traffic accidents on the El Camino Real corridor reported between October 2012 and July 2018. Of these forty-eight (48) pedestrian related accidents, four (4) were reported as fatalities and fifteen (15) as "major injury". Of these same forty-eight (48) accidents, the primary collision factor in eleven (11) of the accidents was determined to be either jaywalking or pedestrian in the roadway related violations. An additional twenty-eight (28) accidents listed a primary collision factor related to drivers failing to yield to pedestrians in lawful crossing areas. In looking at the reported locations of the forty-eight (48) pedestrian related accidents, I noted fourteen (14) appeared to have occurred within approximately 2000 feet in either direction of the intersection of El Camino Real and Millwood Drive

<b>Prepared By:</b> 80205 DRAPER, JAMIE	<b>Date:</b> 11/27/2018	<b>Approved By:</b> 80240 WARREN, JOHN	<b>Date:</b> 12/17/2018
--	----------------------------	---	----------------------------



where Decedent Okobi was first observed crossing the roadway against a red traffic signal.

Sergeant Sebring also provided me a list of traffic citations issued by members of the San Mateo County Sheriff's Office for jaywalking and pedestrian in the roadway related violations which occurred on El Camino Real in Millbrae since 2012. This list contained twenty (20) citations for vehicle code violations related to jaywalking and pedestrians in the roadway. Sergeant Sebring also provided me with a list of traffic citations issued by Deputy Joshua Wang for the past three (3) months. I noted that between July 3, 2018 and September 29, 2018, Deputy Wang issued forty-seven (47) citations for traffic related offenses. Twenty-One (21) of these citations shown a location of occurrence on the El Camino Real corridor through the City of Millbrae. The list did not contain any citations for jaywalking or pedestrian in the roadway related violations, but did include two (2) citations for drivers failing to yield to pedestrians in a crosswalk at intersections on El Camino Real.

**Disposition:**

Attach to Original Report

**CONTROLLED DOCUMENT**

Prepared By:  
80205 DRAPER, JAMIE

Date:  
11/27/2018

Approved By:  
80240 WARREN, JOHN

Date:  
12/17/2018